

**BURNS MAENDEL**  
CONSULTING ENGINEERS LTD.

1331 Princess Ave.  
Brandon, MB R7A 0R4  
Tel: 204.728.7364  
Fax: 204.728.4418

April 14, 2016

Director, Environmental Approvals Branch  
Manitoba Conservation and Water Stewardship  
Suite 160, 123 Main Street  
Winnipeg, MB R3C 1A5

**Reference: Environmental Act Proposal  
Domestic Wastewater Lagoon  
Municipality of Glenella-Lansdowne, MB**

Dear Director,

Burns Maendel Consulting Engineers Ltd. is pleased to submit an Environment Act Proposal for the proposed Domestic Wastewater Lagoon in the Municipality of Glenella-Lansdowne on behalf of New Rosedale Colony. This Domestic Wastewater Lagoon will be sized to treat wastewater from the entire colony as it expands to a design population of 150 people, as well as wastewater from a truckwash and a small abattoir for colony use only.

All of the information relating to the Environmental Act Proposal has been compiled in the attached document. Four (4) hard copies of our proposal have been included, as well as one (1) electronic copy. If you have any questions or comments, please don't hesitate to contact the undersigned.

Regards,

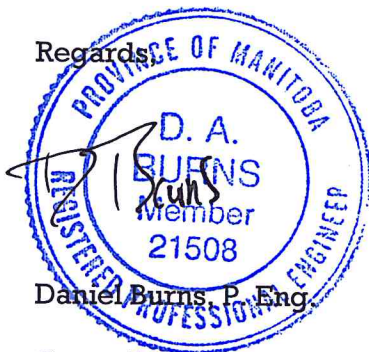

Daniel Burns, P. Eng.

Cc: James Maendel  
Jerry Maendel  
Stanley Baer

/enclosed



**BURNS MAENDEL**  
CONSULTING ENGINEERS LTD.

Director, Environmental Approvals Branch  
Manitoba Conservation and Water Stewardship  
Suite 160, 123 Main Street  
Winnipeg, MB R3C 1A5

**Environmental Act Proposal**  
Domestic Wastewater Lagoon  
Municipality of Glenella-Lansdowne, MB

Submitted by:

Burns Maendel Consulting Engineers Ltd.  
1331 Princess Ave.  
Brandon, MB R7A 0R4  
Tel: 204.728.7364  
Fax: 204.728.4418

On behalf of:

James Maendel  
New Rosedale Holding Co. Ltd.  
Municipality of Glenella-Lansdowne  
Box 460  
Portage La Prairie, MB R0K 3B7  
Tel: 204.252.2053

April 14, 2016

## **Executive Summary**

New Rosedale Colony is planning to establish a daughter colony in the Municipality of Glenella-Lansdowne, approximately 18 km east of the Community of Glenella; the name of the new daughter colony has yet to be decided. New Rosedale Colony plans to establish the new colony on one of a number of properties they own within the area. The colony is currently operating a hog barn located on 23-18-11 WPM, which will serve as the principal industry for the new colony expansion. The new colony will also farm surrounding land, and will build several industrial shops to employ the colony members. The colony has been planning for expansion, and has retained Burns Maendel Consulting Engineers Ltd (BMCE) for engineering support.

As part of the expansion, New Rosedale Colony requires a new wastewater treatment facility to manage their wastewater effluent. Due to the site conditions as well as the isolation of the site, BMCE is proposing a domestic wastewater lagoon be built. BMCE is responsible for the design of the wastewater treatment lagoon, as well as the generation of this corresponding EAP. BMCE is proposing a new two-cell geomembrane-lined lagoon be constructed on SE ¼ 21-18-11 WPM. The primary cell will have a volume of 2,691 m<sup>3</sup> and the secondary cell will have a volume of 10,533 m<sup>3</sup> for a combined total active storage of 11,878 m<sup>3</sup>. The proposed lagoon will be complete with a gas venting and groundwater mitigation system.

The proposed discharge location for the lagoon is into the ditch of Road 104 N adjacent to the SE ¼ 21-18-11 WPM. Once the effluent is discharged from the lagoon, the effluent will be conveyed east along the grid road ditch, where it will connect to the Alonsa Drain, a 3<sup>rd</sup> order drain. This drain in turn will discharge into Jackfish Lake. The termination point at Jackfish Lake is approximately 11.6 km from the initial discharge location. No significant adverse impact on human health or the environment is anticipated to result from the proposed construction and operation of the lagoon, as will be elaborated on within the Environment Act Proposal.

Once approval for the lagoon has been received from Manitoba Conservation, construction is planned to begin in early summer 2016.



## **Standard Limitations**

This report was prepared by Burns Maendel Consulting Engineers Ltd. (BMCE) for the account of New Rosedale Colony (the Client). The disclosure of any information contained in this report is the sole responsibility of the Client. The material in this report reflects BMCE's best judgment in light of the information available to it at the time of preparation. Should this report be used by a third party, any reliance or decisions made based on this report are the responsibility of such third party. BMCE accepts no responsibility for damages, if any, suffered by a third party as a result of decisions made or actions based on this report. BMCE makes no representation concerning the legal significance of the findings or the information contained within this report.

## Table of Contents

1. Introduction and Background.....	1
2. Description of Proposed Development.....	1
2.1. Certificate of Title.....	1
2.2. Legal Land Description, Map of Proposed Development .....	2
2.3. Wastewater Collection System .....	2
2.4. Water Source .....	2
2.5. Sealed Engineering Drawings .....	2
2.6. Sizing Parameters and Calculations.....	2
2.6.1. Summary Table .....	2
*Note: 5% added to minimum volume to account for infiltration.....	4
2.6.2. Hydraulic Loading .....	4
2.6.3. Organic Loading.....	5
2.6.4. Lagoon Design.....	5
2.7. Synthetic Geomembrane Liner Details .....	6
2.8. Discharge Route .....	6
2.9. Facility Operation.....	7
2.10. Seasonal Maintenance.....	8
3. Description of Pre-Development Environment .....	9
3.1. Land Use .....	9
3.2. Topography .....	9
3.3. Soil Conditions .....	9
3.4. Groundwater .....	9
3.5. Protected or Endangered Species .....	9
3.6. Socioeconomic Environment .....	9
4. Description of Environmental and Human Health Effects of the Proposed Development	10
4.1. Impact on Biophysical Environment .....	10
4.1.1. Construction.....	10
4.1.2. Operation.....	11
4.2. Type, Quantity and Concentration of Pollutants .....	11
4.2.1. General .....	11
4.2.2. Phosphorus.....	11

4.2.3. Other Nutrients.....	12
4.3. Fish Habitat .....	12
4.4. Socio-Economic, Climate Change Implications .....	12
4.5. Potential Impact on Human Health and Safety .....	12
5. Mitigation Measures and Residual Environmental Effects.....	13
5.1. Protection.....	13
5.2. Monitoring .....	13

## **List of Appendices**

Appendix A – Drawing Package.....	i
Appendix B – Geotechnical Investigation.....	ii
Appendix C – Certificate of Title .....	iii
Appendix D – Manitoba Conservation Data Centre Correspondence.....	iv
Appendix E – Watershed Drains .....	v

## **1. Introduction and Background**

New Rosedale Colony (legal title New Rosedale Colony Holding Co. Ltd.) is planning to establish a new daughter colony in the Municipality of Glenella-Lansdowne. The name of the daughter colony has yet to be decided, and so will be referred to hereon as New Rosedale Colony (the colony); the official name of the licensee will be provided at a later date. The colony owns a series of properties in the RM consisting of approximately 9682 acres, and plans to establish the colony in W $\frac{1}{2}$  16-18-11 WPM. The colony is currently operating a hog barn on NE $\frac{1}{4}$  23-18-11 WPM, which will serve as the main industry on the colony. The colony will also farm the surrounding areas and will build several industrial shops and houses. To aid in the development process, the colony has retained Burns Maendel Consulting Engineers Ltd. (BMCE) to develop a site concept and layout plan, as well as water and wastewater treatment design.

As New Rosedale Colony is a new colony, they will require a means of managing their wastewater effluent. BMCE is proposing construction of a domestic wastewater stabilization pond, or 'lagoon', for storage and treatment of wastewater prior to discharge into a local ditch. This drain will be identified on a map of the proposed development later in the report. The proposed location for the lagoon is on SE $\frac{1}{4}$  21-18-11 WPM.

Sewage infrastructure for the proposed development will consist of a gravity flow sewer network which would service each of the different housing units in the future colony site, as well as the shops. It should be noted that no industrial waste will be generated at the colony site, except a small amount from the abattoir; the abattoir will be used to process livestock for internal colony use, not for commercial distribution. The gravity flow sewer will be directed to a lift station, which will pump wastewater to the wastewater lagoon. The wastewater lagoon itself will be designed for a future population of 150 people, truck wash wastewater, and abattoir wastewater.

The domestic wastewater lagoon was chosen for wastewater treatment due to several factors. One consideration is that the colony itself is reasonably isolated, as it is approximately 11.5 kilometers away from the nearest community (the hamlet of Waldersee). Another consideration is the ease of use and lack of maintenance required compared to an alternative wastewater treatment system. Finally, there is a convenient discharge location nearby. These combined factors make a lagoon treatment system the most logical method for treating wastewater.

## **2. Description of Proposed Development**

### **2.1. Certificate of Title**

Refer to Appendix C. The legal landowner is New Rosedale Holding Co. Ltd.

## 2.2. Legal Land Description, Map of Proposed Development

The legal land description where the domestic wastewater lagoon is situated is SE¼ 21-18-11 WPM. For the map of the proposed development including the preliminary layout of the colony site, piping and lift station refer to the drawing package in Appendix A.

## 2.3. Wastewater Collection System

Wastewater for the colony will be collected via a gravity sewer system network. Wastewater will drain to a lift station, which will in turn pump wastewater via forcemain to the wastewater lagoon. As per Manitoba Conservation requirements, the colony will be required to submit an application for a certificate of approval for a wastewater collection system. This will be applied for at a later date once the design of the wastewater collection system has been finalized.

## 2.4. Water Source

Water for the colony will be drawn from a groundwater well and will be pumped to the different colony buildings. A groundwater exploration program has been completed, and a well will be located on Section 9-18-11 WPM. A water distribution system has not been designed, as the colony planning is still in the conceptual stage. Finally, a water rights license will be applied for at the appropriate time once the design has been finalized.

## 2.5. Sealed Engineering Drawings

Refer to Appendix A.

## 2.6. Sizing Parameters and Calculations

### 2.6.1. Summary Table

Parameter	Result
<b>DOMESTIC WW LOADING</b>	
Detention Time (days)	230
Population	150
Hydraulic Loading Rate (L/c/d)	300
Required Storage Volume (m <sup>3</sup> )	10,350
<b>TRUCK WASH</b>	
Detention Time (days)	230
Running Time (h/day)	4
Weekly Usage (days/week)	6
Hydraulic Loading Rate (L/min)	18.9
Required Storage Volume (m <sup>3</sup> )	895



<b>ABATTOIRE</b>			
<b>LIVESTOCK LOADING RATE</b>			
Livestock Type	Quantity	Washwater Loading	Annual Loading
	(head)	(L/head)	(L)
Broilers	5,000	11	55,000
Ducks	1,000	11	11,000
Geese	200	11	2,200
Turkeys	600	11	6,600
Hogs	30	757	22,700
Beef Cattle	6	1,514	9,100
Annual Washwater Loading Rate (m <sup>3</sup> /year)		106.6	
Avg Daily Washwater Loading Rate (m <sup>3</sup> /d)		0.29	
Detention Time (d)		230	
Required Storage Volume (m <sup>3</sup> )		67	
<b>STORAGE VOLUME</b>			
<b>*Minimum Required Storage (m<sup>3</sup>)</b>		<b>11,878</b>	
Minimum Required Primary Cell Volume (m <sup>3</sup> )		2,691	
Minimum Required Secondary Cell Volume (m <sup>3</sup> )		10,546	
<b>Total Storage Volume (m<sup>3</sup>)</b>		<b>11,878</b>	
Primary Cell Storage Volume (m <sup>3</sup> )		2,691	
Secondary Cell Storage Volume (m <sup>3</sup> )		10,546	
<b>ORGANIC LOADING</b>			
Detention Time (days)		230	
Population		150	
Individual Organic Loading Rate (kg BOD <sub>5</sub> / c / d)		0.077	
Daily Population BOD <sub>5</sub> Loading (kg BOD <sub>5</sub> / d)		11.55	
Poultry – Washwater BOD <sub>5</sub> Concentration(mg/L)		1,648	
Hogs – Washwater BOD <sub>5</sub> Concentration (mg/L)		4,711	
Cattle – Washwater BOD <sub>5</sub> Concentration (mg/L)		14,545	
Poultry – Washwater BOD <sub>5</sub> Loading (kg BOD <sub>5</sub> /d)		0.37	
Hogs – Washwater BOD <sub>5</sub> Loading (kg BOD <sub>5</sub> /d)		0.30	
Cattle – Washwater BOD <sub>5</sub> Loading (kg BOD <sub>5</sub> /d)		0.34	
Total Livestock – Washwater Loading (kg BOD <sub>5</sub> /d)		1.01	
Total BOD <sub>5</sub> Loading (kg BOD <sub>5</sub> / d)		12.56	
Organic Loading per Area (kg BOD <sub>5</sub> / ha·d)		56	
Minimum Primary Cell Area (m <sup>2</sup> )		2,242	
Primary Cell Area (m <sup>2</sup> )		2,242	

<b>LAGOON DIMENSIONS</b>	
Active Storage Depth (m)	1.50
Freeboard (m)	1.00
Dead Space (m)	0.30
Total Depth (m)	2.50
Cell Interior Side Slope	5:1
Primary Cell Outer Dimensions - L x W x H (m)	90.0 x 46.3 x 2.5
Primary Cell Floor Dimensions - L x W (m)	65.0 x 21.3
Secondary Cell Outer Dimensions - L x W x H (m)	134.6 x 90.0 x 2.5
Secondary Cell Floor Dimensions - L x W (m)	109.6 x 65.0

\*Note: 5% added to minimum volume to account for infiltration.

### 2.6.2. Hydraulic Loading

- The design population was set at **150 people**, the expected colony size before a daughter colony is formed.
- The hydraulic loading attributable to the colony members was estimated at a conservative value of **300 L/c/d**. This is based off of literature values as well as historical design wastewater loading rates from other colonies.
- The hydraulic loading attributable to the truck wash was estimated at **18.9 L/min** (5.0 US GPM). The runtime was conservatively assumed at 4 hours per day, 6 days per week.
- The wastewater volume attributable to the abattoir was estimated at **292 L/day**. This is based on an assumed loading of 1516 L (400 US gallons) per head of cattle, 758 L (200 US gallons) per hog, and 11 L (3 US gallons) per bird. The quantity of livestock is described above.
- The detention time was set at **230 days**. 227-230 days are commonly used detention times, based on the operational requirement that the wastewater effluent be discharged between June 15 and November 1.
- Therefore, the required **Minimum Total Storage Volume** based upon the hydraulic loading parameters listed above is **11,878 m<sup>3</sup>**.

### 2.6.3. Organic Loading

- Again, the design population was set at **150 people**, the maximum expected colony size before a daughter colony is formed.
- The design organic loading rate per person is set at **0.077 kg BOD/person/day**. This is a value used commonly in wastewater treatment design in Manitoba.
- A separate license for the abattoir under the Environment Act will be applied for at a later date. However, for the purposes of this assessment, the lagoon will receive wastewater in the form of wash water contaminated with blood and other deleterious organic matter. It should be noted that a blood collection system will be installed to capture as much blood as possible.
- Wastewater from the abattoir will be contaminated with organic matter, notably blood not captured in the blood collection system. Table 2.5.1 summarizes the anticipated wastewater characteristics; the anticipated organic loading from the abattoir has been incorporated in the primary cell area calculation.
- The maximum organic loading is set at **56 kg BOD / (ha\*d)**. This value is commonly used in wastewater lagoon design across Manitoba.
- While some organic matter may be present in the truck wash wastewater, the contribution is considered negligible.
- Based on the annual loading characteristics, daily organic loading was averaged at 12.56 kg BOD<sub>5</sub>/d.
- Therefore, on the basis of the above treatment parameters, the minimum area needed in the primary cell is **2,243 m<sup>2</sup>**,

Area = daily organic loading / organic loading rate

Area = [12.56 kg BOD<sub>5</sub>/d] / [56 kg BOD / (ha\*d)]

Area = 0.2243 ha = 2,243 m<sup>2</sup>

### 2.6.4. Lagoon Design

- The required **Minimum Total Storage Volume** is **11,878 m<sup>3</sup>**. Based upon the hydraulic and organic loading requirements, the **Minimum Primary Cell Storage Volume** will be equal to

**2,691 m<sup>3</sup>.** The **Minimum Secondary Cell Storage Volume** will be **10,533 m<sup>3</sup>.** Common practice for lagoon design in Manitoba is to size the lagoon such that half of the primary cell volume and the full secondary cell volume contributes to the active storage. This is to account for the fact that some of the liquid will remain in the primary cell during each discharge cycle.

- As per common practice and design standards for wastewater lagoon design, the available storage will be 1.5 m, and active storage will be 1.2 m.
- As per common practice and design standards for wastewater lagoon design, the available freeboard will be 1.0 m.
- The area below the secondary cell pipe invert is considered dead storage, and is not part of the design storage volume or freeboard. The dead storage height is 0.30 m, as per common design practice and Manitoba Conservation design standards.
- The interior slope of the primary and secondary cell will be 5:1. The outside of the berm will also have a slope of 5:1.
- For all other lagoon design details, refer to the drawings in Appendix A.

## **2.7. Synthetic Geomembrane Liner Details**

A synthetic geomembrane liner will be used as the surrounding soil is low plastic clay, glacial till, or silt, prohibiting use of a compacted clay lined design, and there is no clay deposit readily available for a clay liner. Cover material will be placed over the lagoon bottom for a depth of 300 mm. A gas ventilation system consisting of a perforated pipe network will be used to prevent gas build-up underneath the synthetic liner. The perforated pipe network can also function as a dewatering system if required. For drawing details, refer to Appendix A.

Additionally, a pipe penetration detail has been shown in the design drawings. While the poly-board is a different material than the 60 mil HDPE liner, the poly-board material will have a minimum thickness of 60 mil to ensure environmental protection is maintained.

## **2.8. Discharge Route**

The lagoon is to be constructed adjacent to Road 104 N on the south side of the quarter section. The proposed discharge point is into the road ditch.

Once the effluent is discharged from the lagoon, the effluent is conveyed east along the grid road ditch, where it connects to the Alonsa Drain, a 3<sup>rd</sup> order drain. This drain in turn discharges into Jackfish Lake. The termination point at Jackfish Lake is approximately 11.6 km from the initial discharge location. Refer to Appendix E for the watershed map.

Figure 1: Discharge Route

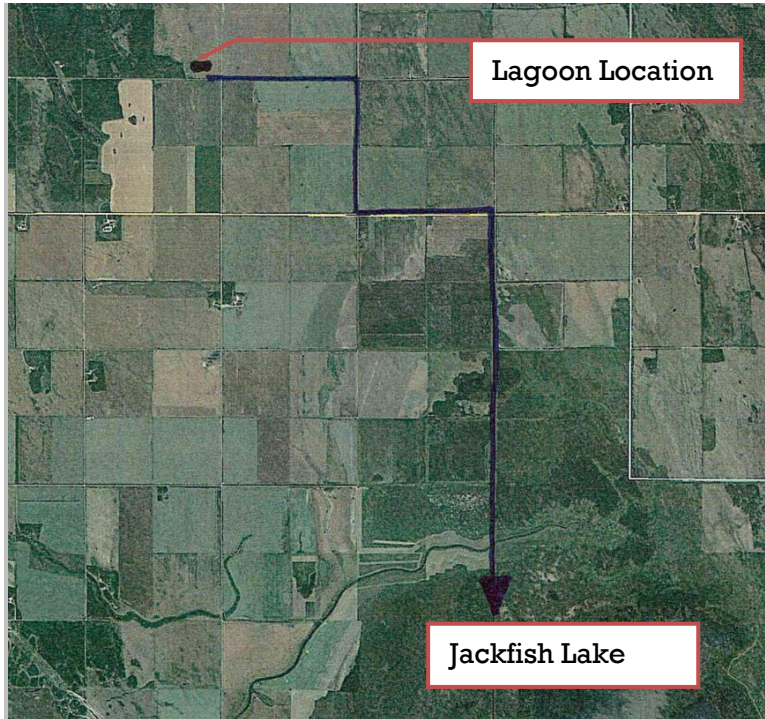

As the effluent will be discharged in accordance with Manitoba Conservation regulations, the effluent should meet discharge criteria. The ditch is also expected to dilute and polish the wastewater, and plant-life should absorb excess nutrients. This will be elaborated on later in the report.

As the lagoon is discharging into a ditch, and the discharge route is approximately 11.6 km before discharging into Jackfish Lake, there is no anticipated effect on public water users downstream.

## 2.9. Facility Operation

Wastewater effluent will be pumped from the lift station to the lagoon, where the wastewater will be stored and treated until it is released in the spring and fall.

The discharge operation is summarized in the following steps:

- a) Two weeks prior to the time of sampling the valve permitting flow between the primary and secondary cell will be closed. This will ensure a representative water sample can be taken from the secondary cell.
- b) Two weeks after the valve has been closed, a water sample from the secondary cell will be obtained, using sample bottles supplied from an accredited laboratory. Water sampling and submission procedures will be performed in accordance with Manitoba Conservation and laboratory guidelines.
- c) If the water samples meet Manitoba Conservation requirements water from the secondary cell can be discharged. Water will only be discharged within the June 15 to November 1 time period. If the samples do not meet Manitoba Conservation requirements, testing will be repeated until the samples have passed the testing criteria. Additional time will allow for natural processes such as sunlight and settling to have an effect on the wastewater effluent quality.
- d) Once the effluent has been drained from the secondary cell, the discharge valve will be closed and the valve permitting flow between the primary and secondary cell will be opened.
- e) Once the water level between the primary and secondary cell has been equalized, the secondary cell can be drained a second time if necessary to ensure adequate capacity. In this event, the valve between the primary and secondary cell will again need to be closed for two weeks, and the secondary cell wastewater will need to be re-tested prior to discharge. However, we do not anticipate a second discharge will be necessary.

## **2.10. Seasonal Maintenance**

Regular observation of the lagoon will be undertaken by colony members to ensure that there are no malfunctions or degradation. The following tasks will be performed to ensure that the integrity of the lagoon is maintained and that it functions properly;

- The lagoon will be inspected for signs of wildlife. Any wildlife burrowing into the berm or otherwise causing damage will be relocated.
- Valves and drainage areas will be checked and cleared of obstructions on a regular basis.
- Snow will be cleared on the roads so that the lagoon may be accessed at any time.

### **3. Description of Pre-Development Environment**

#### **3.1. Land Use**

The current land use is cultivated farmland. New Rosedale Colony is actively using this land to grow crops. Zoning is currently designated as Agriculture Restricted Zone (AR-2).

#### **3.2. Topography**

The location of the lagoon will be on the south side of the quarter section, to the east of a forested area. The land is relatively flat, with a gradual slope to the east. This will help ensure stormwater runoff is drained away from the lagoon.

#### **3.3. Soil Conditions**

The soil stratigraphy in the upper 9.1 m within or close to the proposed lagoon location was visually classified as topsoil, glacial till, clay or silt. All the soil types encountered within or close to the lagoon footprint were visually assessed to be low plastic, excluding said topsoil. For detailed information on soil types and layers, refer to the geotechnical report in Appendix B.

#### **3.4. Groundwater**

No groundwater was observed during drilling. There was, however, some seepage and sloughing that occurred at the clay and silt layers, indicating the potential presence of preferential flow paths and localized confining layers. For more detailed information, refer to the geotechnical report in Appendix B.

#### **3.5. Protected or Endangered Species**

The Manitoba Conservation Data Centre was contacted to ensure that there were no protected or endangered species observed in the vicinity of the proposed construction site. Manitoba Conservation confirmed that no occurrences of rare or endangered species have been noted in the project area. We have enclosed their response in Appendix D.

It should also be noted that as the land use is cultivated farmland, natural native land and habitat will not be impacted by the change in land use. Additionally, prior to construction the land was inspected to confirm there was no extensive wildlife habitat.

#### **3.6. Socioeconomic Environment**

The socioeconomic environment is not a large factor in this development, as the lagoon is being constructed over active crop land. The lagoon itself is situated across Road 104 N and on the opposite side of a forested area from the colony. Road 104 N and the forested area will act as a natural boundary separating the lagoon from the colony itself. New Rosedale Colony itself will be 1.4 km from

the lagoon, while the nearest neighboring residence not associated with the colony is approximately 2.7 km away, as per Figure 2.

Figure 2: Neighboring Residence

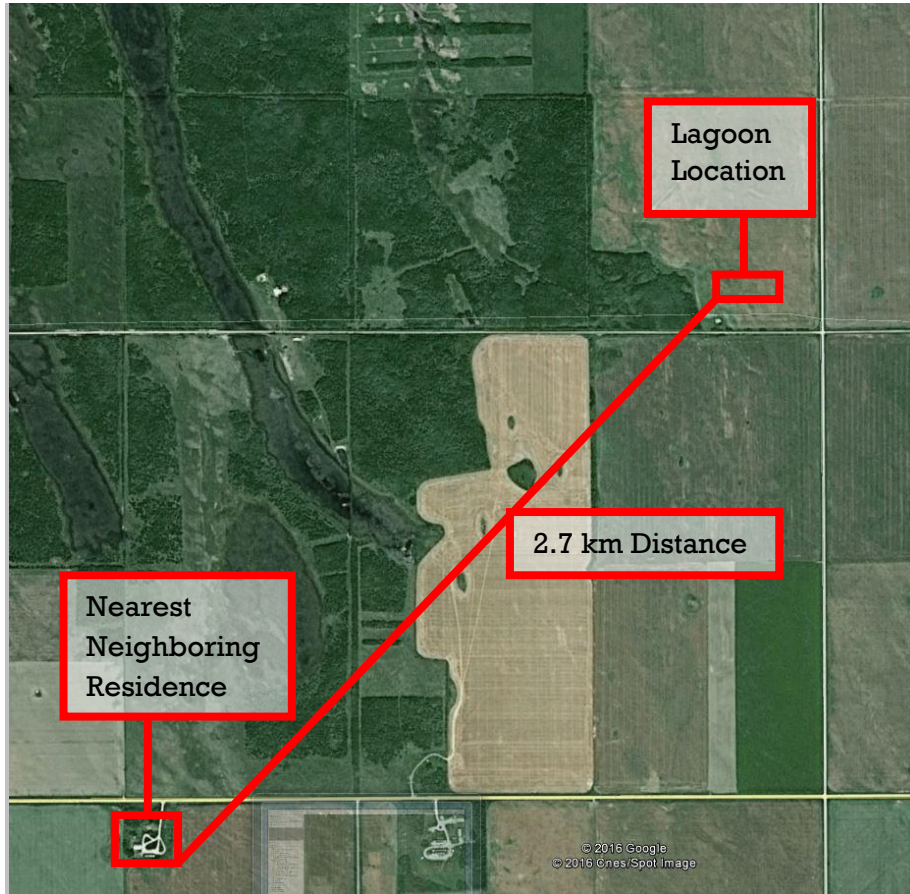

## 4. Description of Environmental and Human Health Effects of the Proposed Development

### 4.1. Impact on Biophysical Environment

#### 4.1.1. Construction

Actual construction of the facility will involve land clearing, excavation, and construction of the lagoon itself. As the existing land use is currently cultivated farmland with no tree or bush cover, the impact on the natural terrestrial environment is expected to be minimal. Furthermore, as per correspondence with Manitoba Conservation referenced in the previous section, there are no protected or endangered species within the construction area. Also, as there is Road 104 N and forested area separating the colony from the lagoon, directional drilling will be used to connect the pipe from the colony to the lagoon.



#### **4.1.2. Operation**

Once the lagoon is constructed, no impact is expected on local groundwater. Simply put, a properly designed and functioning lagoon will not allow wastewater to infiltrate into the surrounding environment except during wastewater discharge, which only occurs once wastewater has been treated to acceptable levels. Additionally, groundwater in the area is difficult to locate, as groundwater sources consist of smaller perched aquifers and a deep aquifer with brackish water. Further risk is mitigated by the fact that there are no active water wells within the immediate quarter section that the lagoon will be built on.

### **4.2. Type, Quantity and Concentration of Pollutants**

#### **4.2.1. General**

Treated effluent, tested according to the Manitoba Conservation license requirements, will be discharged into the ditch of Road 104 N, as shown in Appendix E and *Figure 1*. As is commonly allowed in existing lagoon licenses, effluent will be discharged between June 16<sup>th</sup> and November 1<sup>st</sup> of any year. Effluent must be tested to determine whether it is consistent with Manitoba Conservation guidelines. Regulations for nutrient concentrations are laid out in The Water Protection Act. The Act sites Manitoba Water Quality Standards, Objectives, and Guidelines for the limits on acceptable wastewater discharge

Odor is only expected to be a factor during spring and fall turnover, as this the time when noxious gases are released. This will be mitigated by the fact that the prevailing wind should direct the odors away from the colony. Furthermore, the nearest neighbor community is approximately 2.7 km away, giving time for the odor to disperse.

#### **4.2.2. Phosphorus**

The limit for phosphorus concentration for an equivalent population less than 2,000 is 1 mg/L or a demonstrated nutrient reduction strategy. Testing will be performed two weeks prior to discharge to determine whether the effluent is suitable for release. We note that the discharge route is long and contains considerable plant-life. The plant-life along the drain will uptake additional phosphorus as part of their natural processes, effectively cleansing the effluent. As per typical lagoon discharge operations, a trickle discharge over a 2 week interval will be utilized to minimize phosphorus concentrations from impacting the water quality at one specific point.

If there is consistent difficulty in meeting the phosphorus concentration targets or if regulations become more conservative in the future, a more intensive nutrient reduction strategy will be implemented. Phosphorus reduction will have to include the addition aluminum sulfate (alum) to cause phosphorus to

settle. Once the flocculent has settled, it can be collected off the cell bottom once the lagoon is drained.

#### **4.2.3. Other Nutrients**

Other nutrients of concern during testing include nitrogen, total coliforms / fecal coliforms, 5-day biochemical oxygen demand, and total suspended sediment. All parameters will be tested according to the standards set out in the Manitoba Water Quality Standards, Objectives and Guidelines 2011 document. In the event that any of the tests fail, water will be re-tested according to the procedure set out in Section 2.9 Facility Operation.

#### **4.3. Fish Habitat**

The initial 11.6 km of road ditch is not fish habitat. As this is a significant distance, there is additional time for the natural polishing processes of the ditch plant-life to absorb excess nutrients and for extend sedimentation time.

#### **4.4. Socio-Economic, Climate Change Implications**

The colony will require a wastewater treatment system in order to establish the new site. As such, this is therefore an important project from a socio-economic perspective, as it will allow a new colony to be constructed. This will have a large impact on the surrounding community, as a colony is a major consumer and supplier of goods and services. In addition, the colony will be a significant source of tax revenue for the Municipality of Glenella-Lansdowne.

Also, as this is a small lagoon taking advantage of natural treatment processes, no significant climate change impacts are expected.

#### **4.5. Potential Impact on Human Health and Safety**

The site location is within established farmland, away from any dwelling spaces or commercial/industrial buildings. Given the isolation of the site, it should not be considered an attractive nuisance. The smell and appearance of the lagoon should further discourage people from coming near.

Safety features will include a 6-foot tall fence and descriptive signs to discourage unauthorized access to the lagoon, and to make known the potential danger. In the event that someone enters the lagoon facility area unauthorized and falls in, the synthetic liner will be textured to provide extra grip. Additionally, a ramp will be constructed within each cell to provide an exit point.

The effluent discharge route consists of a road ditch for the initial discharge distance route of 11.6 km prior to release into Jackfish Lake. No risk is anticipated on public users, and as such there is no anticipated impact on human health and safety.

## **5. Mitigation Measures and Residual Environmental Effects**

### **5.1. Protection**

The practices to be used during construction are common to projects of a similar nature. As this facility will be built on previously cultivated farmland and will have a relatively small footprint, we anticipate that our proposed design will not adversely affect the environment. A geomembrane-lined lagoon will provide environmentally sound storage and treatment of wastewater.

A dewatering and gas-venting system will be used in this design. This will ensure that if there are any holes in the synthetic liner there will be a safeguard against large gas pockets lifting the liner above the water surface. The gas venting and liner system will be installed to run along the floor of the lagoon and directly through the berm. The system will then discharge from the outer walls of the berm.

### **5.2. Monitoring**

On-going monitoring of the lagoon will be performed to ensure the proper functioning of the lagoon. Regular inspection will ensure that there is no damage to the lagoon from erosion, failures or other causes. Further attention will be paid to odor, and if excessive odor is noticeable the cause will be identified and dealt with accordingly. The general condition of the lagoon will be observed on an ongoing basis during all seasons.



## Appendix A – Drawing Package

**BURNS MAENDEL**  
CONSULTING ENGINEERS LTD.

1331 Princess Ave.  
Brandon, Manitoba  
R7A 0R4  
Tel: (204) 728-7364  
Fax: (204) 728-4418



**NEW ROSEDALE COLONY  
LAGOON DESIGN  
SE 21-18-11 WPM**

CIVIL DRAWINGS		
DWG NO.	DRAWING NAME	REV
C1.1	LAGOON LOCATION PLAN	1
C1.2	LAGOON PLAN VIEW	1
C3.1	LAGOON CROSS SECTIONS	1
C3.2	SECTIONS & DETAILS	1
C3.3	FENCE, SIGNAGE & ROAD DETAILS	1
BUILDING DRAWINGS		
DWG NO.	DRAWING NAME	REV
STRUCTURAL DRAWINGS		
DWG NO.	DRAWING NAME	REV
PROJECT DESCRIPTION		
DATE	PROJECT NO:	
APR 14, 2016	BMCE14-166-36	



**LOCATION PLAN**  
SCALE: N.T.S.

POINT TABLE			
POINT #	ELEVATION	NORTHING	EASTING
1	270.70	5599924.59	505565.97
2	270.70	5600014.59	505565.97
3	270.70	5600014.59	505749.87
4	270.70	5599924.59	505749.87
5	268.00	5599937.09	505578.47
6	268.20	5600002.09	505578.47
7	268.20	5600002.09	505599.77
8	268.00	5599937.09	505599.77
9	268.00	5599937.09	505627.77
10	268.20	5600002.09	505627.77
11	268.20	5600002.09	505737.37
12	268.00	5599937.09	505737.37

NOTE: ALL INTERIOR LAGOON ELEVATIONS ARE TO TOP OF SAND COVER, NOT HDPE LINER.

EARTHWORK QUANTITIES		
MATERIAL	CUT MATERIAL	FILL MATERIAL
TOPSOIL STRIPPING	4577m <sup>3</sup>	N/A
COMMON EXCAVATION	10722m <sup>3</sup>	8757m <sup>3</sup>
SAND COVER	N/A	2552m <sup>3</sup>
TOPSOIL PLACEMENT	N/A	602m <sup>3</sup>
SEEDING	4173m <sup>2</sup>	N/A

NOTE: ALL QUANTITIES ARE BASED ON IN SITU CONDITIONS

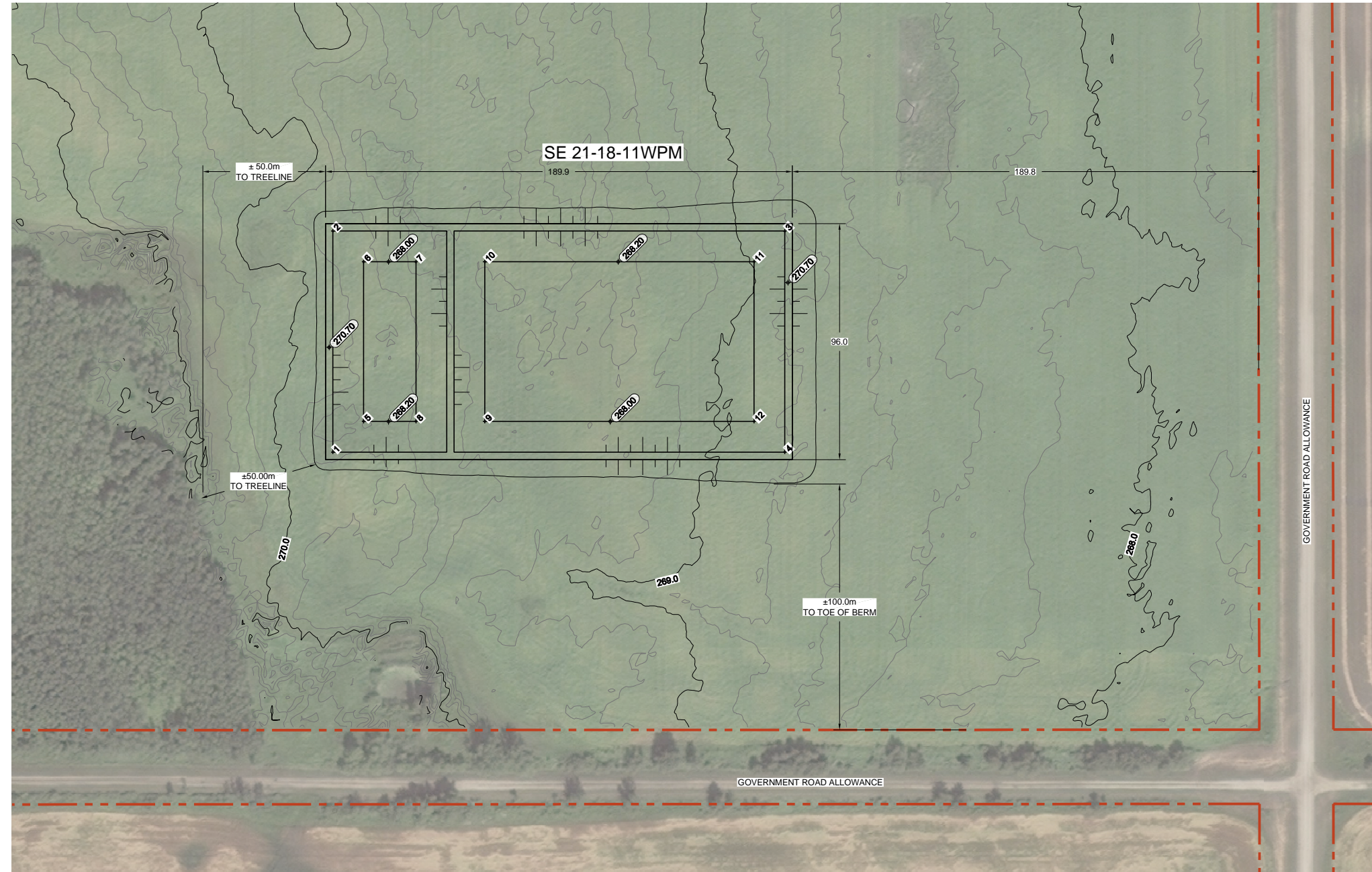

**PROPOSED LAGOON SITE**  
SCALE: 1:1,000



ID	DATE	APP.	BY	DESCRIPTION
1	APR 14, 2016	D.B.	J.K.	REVISIONS AS PER MB CONSERVATION COMMENTS
2	FEB 18, 2016	D.B.	J.K.	ISSUED WITH ENVIRONMENTAL ACT PROPOSAL
3	FEB 2, 2016	JA	J.K.	ISSUED FOR CLIENT REVIEW AND COMMENT
4	NOV 26, 2015	JA	CR	ISSUED FOR CLIENT REVIEW AND COMMENT



DESIGNED BY: JA	REVIEWED BY: DAB	PROJECT NAME: <b>NEW ROSEDALE COLONY LAGOON DESIGN SE 21-18-11 WPM</b>	DRAWING TITLE: <b>LAGOON LOCATION PLAN</b>
DRAWN BY: CR	PROJECT START DATE: NOV 26, 2015	1331 Princess Ave. Brandon, Manitoba R7A 0R4 Tel: (204) 728-7364 Fax: (204) 728-4418	PROJECT NUMBER: <b>BMCE-14-166-36</b>
PLOT SIZE: A1 (594x841)	SCALE: AS NOTED		

**LAGOON DESIGN PARAMETERS:**

DOMESTIC LOADING  
 DETENTION TIME: 230 DAYS  
 LOADING RATE: 300 LITRES / PERSON / DAY  
 POPULATION: 150 PEOPLE  
 ORGANIC LOADING: 0.077kg BOD5 / PERSON / DAY  
 ORGANIC LOADING / AREA: 56 kg BOD5 / (HA\*DAY)

TRUCK WASH  
 DETENTION TIME: 230 DAYS  
 LOADING RATE: 18.9 LITRES / MINUTE  
 RUNNING TIME: 4 HOURS / DAY  
 WEEKLY USAGE: 6 DAYS / WEEK

ABATTOIR  
 TOTAL WASHWATER: 109.3m<sup>3</sup>  
 TOTAL BLOOD: 0.659m<sup>3</sup>  
 ORGANIC LOADING: 0.2kg BOD5 / L  
 ORGANIC LOADING / AREA: 56 kg BOD5

**LAGOON GEOMETRIC PARAMETERS:**

CELL HEIGHT (INCLUDES DEAD SPACE): 1.50 m  
 FREEBOARD: 1.00 m  
 INTERIOR SIDE SLOPE: 5:1  
 EXTERIOR SIDE SLOPE: 5:1

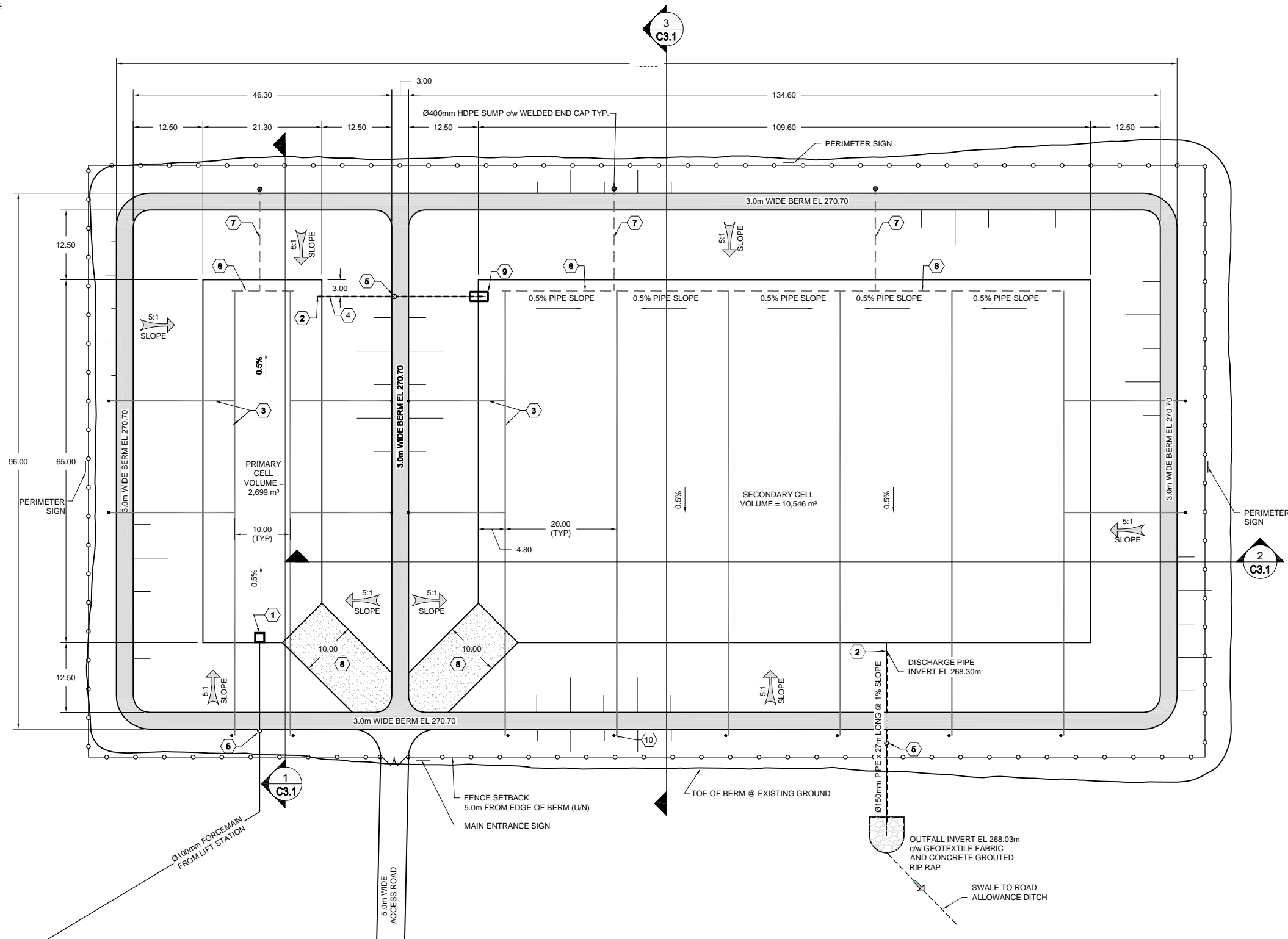

**GENERAL NOTES**

1. DECIMALIZED NUMBERS INDICATE METRES AND WHOLE NUMBERS INDICATE MILLIMETRES.
2. EXISTING FEATURE LOCATIONS & PROPERTY LINE INFORMATION IS DERIVED FROM SURVEY INFORMATION COLLECTED BY RICHMOND SURVEYS.
3. CONFIRMATION OF EXISTENCE AND EXACT LOCATION OF ALL SERVICES MUST BE OBTAINED FROM THE INDIVIDUAL UTILITIES BEFORE PROCEEDING WITH CONSTRUCTION.
4. ALL CONSTRUCTION TO BE IN ACCORDANCE WITH THE LATEST EDITION OF MANITOBA WATER STEWARDSHIP STANDARD CONSTRUCTION SPECIFICATIONS.

**CONSTRUCTION NOTES**

1. ALL HDPE LINER TO BE 60MIL SINGLE SIDED TEXTURED HDPE UNDERLAIN BY 8oz NON WOVEN GEOTEXTILE FABRIC.

**KEYNOTES**

1. 1800 x 1800 x 150mm THICK CONCRETE INLET PAD c/w 200mm HIGH CURB, SEE DETAIL.
2. POLY-PLATE PIPE PENETRATION. SEE DETAIL.
3. Ø100mm PERFORATED GAS VENTING PIPE SPACED @ 20.0m o/c e/w WAY IN SECONDARY CELL AND @ 10m o/c e/w IN PRIMARY CELL.
4. Ø150mm EQUALIZATION PIPE.
5. GATE VALVE.
6. Ø100mm PERFORATED DEWATERING PIPE SLOPED @ 0.5%.
7. Ø100mm HDPE COLLECTION PIPE (NON-PERFORATED).
8. 10.0m WIDE ACCESS PAD c/w 300mm SAND COVER OVER HDPE LINER AND GEOTEXTILE.
9. POLY-PLATE PIPE PENETRATION c/w 1800mm WIDE x 150mm THICK CONCRETE SPLASH PAD w/ 200mm HIGH CURB. SEE DETAIL.
10. TRAP VENT COMPLETE w/ INSECT SCREEN. TYP.

ID	DATE	APP.	BY	DESCRIPTION
1	APR 14, 2016	D.B.	J.K.	REVISIONS AS PER MB CONSERVATION COMMENTS
2	FEB 18, 2016	D.B.	J.K.	ISSUED WITH ENVIRONMENTAL ACT PROPOSAL



Certificate of Authorization  
 Burns Maendel Consulting Engineers Ltd.  
 No. 4559 Expiry: April 30, 2017



DESIGNED BY: J.A.	REVIEWED BY: D.B.	PROJECT NAME: <b>NEW ROSEDALE COLONY LAGOON DESIGN SE-21-18-11 WPM</b>
DRAWN BY: J.K.		 <p>1331 Princess Ave.                  Brandon, Manitoba                  R7A 0R4                  Tel: (204) 728-7364                  Fax: (204) 728-4418</p>
PROJECT START DATE: DEC 2015		
PLOT SIZE: A1 (594x841)		
SCALE: AS NOTED		PROJECT NUMBER: <b>BMCE14-166-36</b>

DRAWING TITLE: <b>LAGOON PLAN VIEW</b>	
DRAWING NO: <b>C1.2</b>	

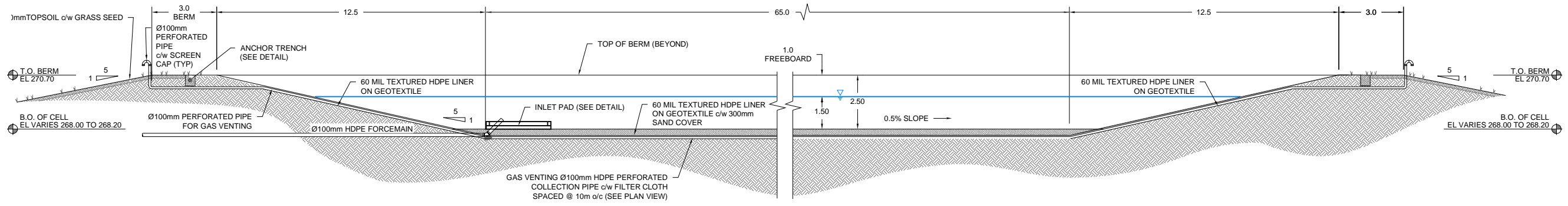

**1 PRIMARY CELL SECTION**  
**C1.2** SCALE: 1:100

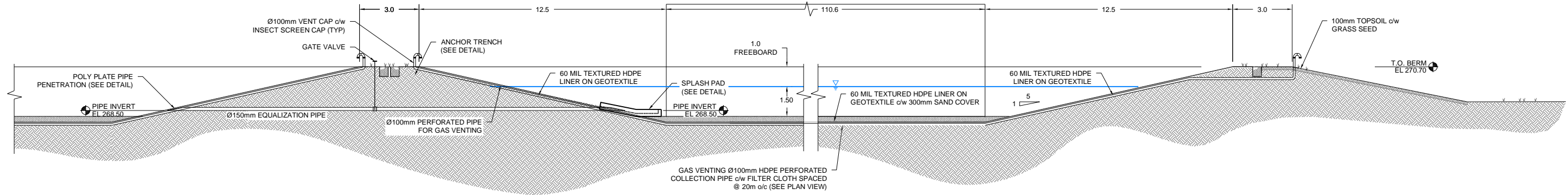

**2 DEWATERING SYSTEM**  
**C1.2** SCALE: 1:100

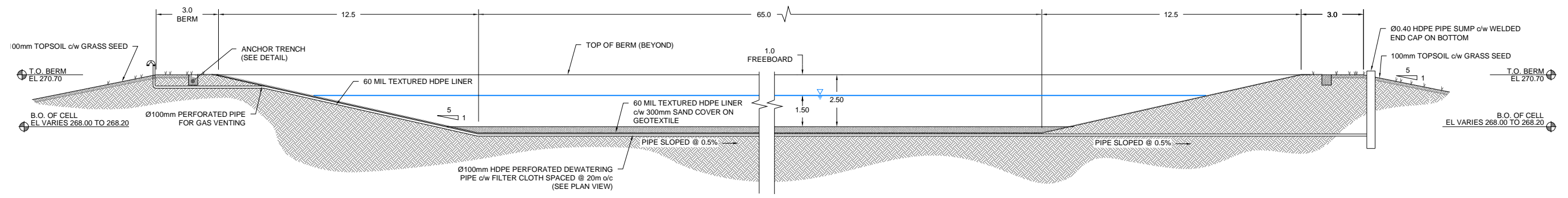

**3 SECONDARY CELL SECTION**  
**C1.2** SCALE: 1:100

ID	DATE	APP.	BY	DESCRIPTION
1	APR 14, 2016	D.B.	J.K.	REVISIONS AS PER MB CONSERVATION COMMENTS
2	FEB 18, 2016	D.B.	J.K.	ISSUED WITH ENVIRONMENTAL ACT PROPOSAL
REVISIONS				

**APECM**  
 Certificate of Authorization  
 Burns Maendel Consulting  
 Engineers Ltd.  
 No. 4559 Expiry: April 30, 2017



DESIGNED BY: J.A.  
 REVIEWED BY: D.B.  
 DRAWN BY: J.K.  
 PROJECT START DATE: DEC 2015  
 PLOT SIZE: A1 (594x841)  
 SCALE: AS NOTED

PROJECT NAME:  
**NEW ROSEDALE COLONY  
 LAGOON DESIGN  
 SE 21-18-11 WPM**

**BURNS MAENDEL  
 CONSULTING ENGINEERS LTD.**  
 1331 Princess Ave.  
 Brandon, Manitoba  
 R7A 0R4  
 Tel: (204) 728-7364  
 Fax: (204) 728-4418

DRAWING TITLE:  
**LAGOON CROSS SECTIONS**

PROJECT NUMBER: **BMCE14-166-36**  
 DRAWING NO: **C3.1**



**GENERAL NOTES**

1. ALL POLYBOARD SHALL BE MIN 60 MIL IN THICKNESS.
2. ALL CONSTRUCTION TO BE IN ACCORDANCE WITH THE LATEST EDITION OF MANITOBA WATER STEWARDSHIP STANDARD CONSTRUCTION SPECIFICATIONS.

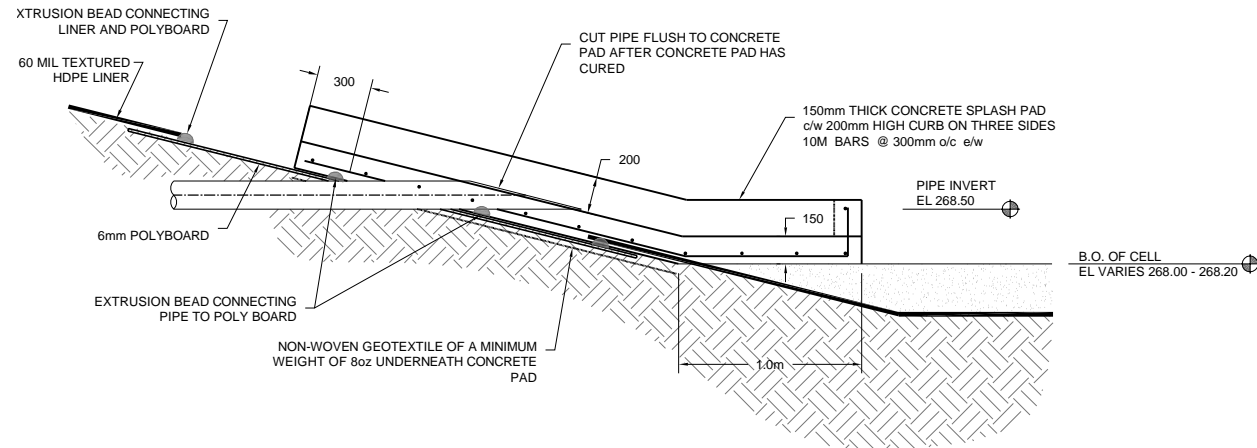

**POLY-PLATE PIPE PENETRATION w/ SPLASH PAD**  
SCALE: 1:50

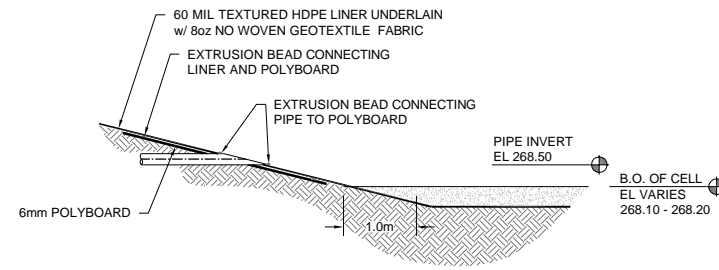

**POLY-PLATE PIPE PENETRATION**  
SCALE: 1:50

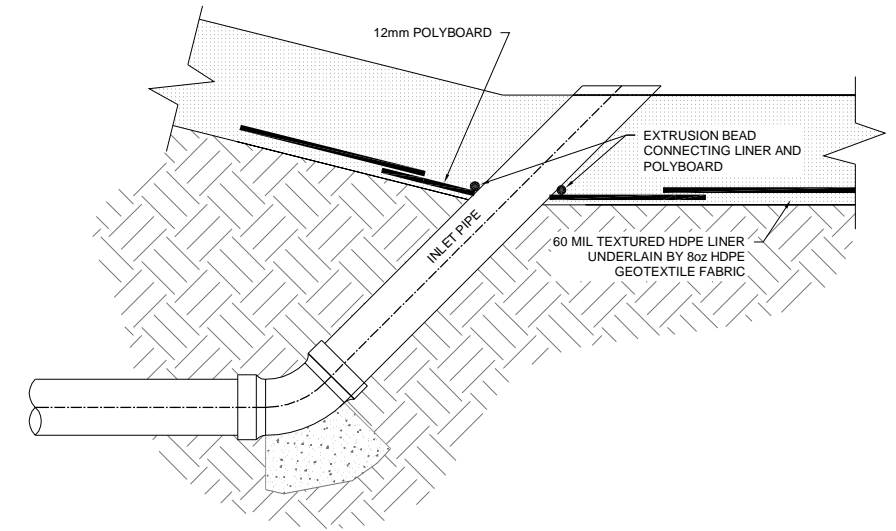

**PIPE PLATE DETAIL**  
SCALE: 1:10

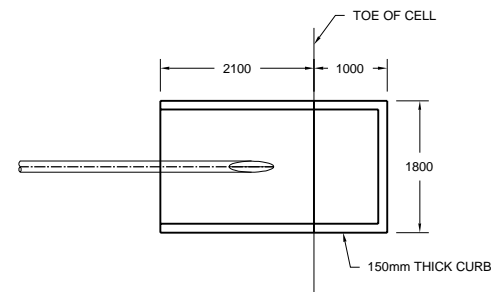

**TYPICAL SPLASH PAD - PLAN VIEW**  
SCALE: 1:50

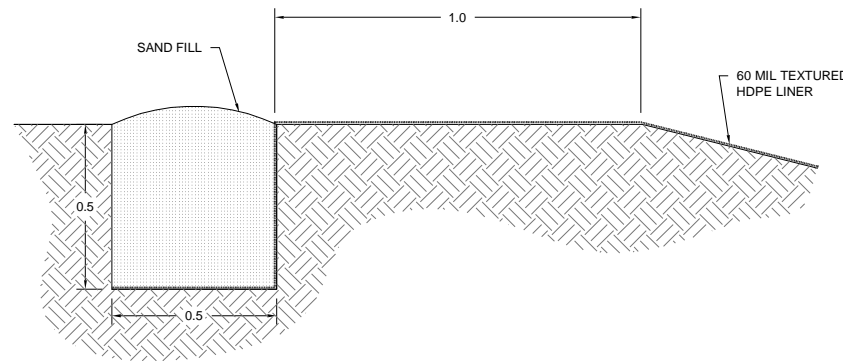

**LINER ANCHOR DETAIL**  
SCALE: 1:10

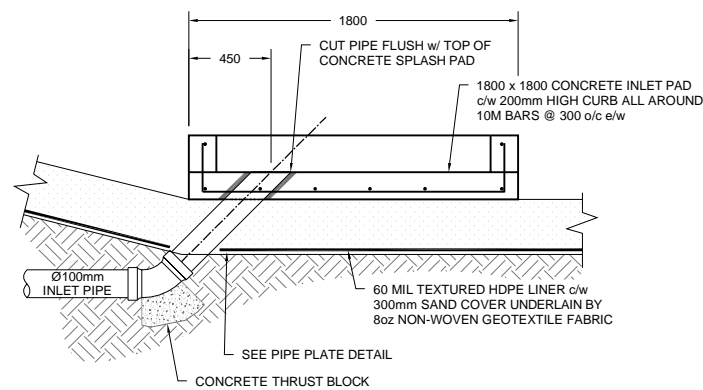

**INLET PAD DETAIL**  
SCALE: 1:20

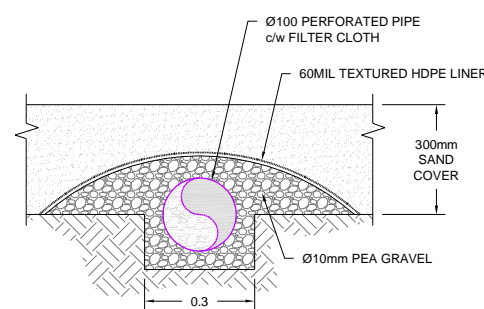

**DEWATERING PIPE DETAIL**  
SCALE: 1:10

- (1) GRADE
- (2) DUCTILE IRON UPPER SECTION
- (3) 50mm SQUARE OPERATING NUT
- (4) STONE DISC.
- (5) ADJUSTABLE VALVE BOX
- (6) PVC or DUCTILE IRON LOWER SECTION
- (7) MINIMUM 50mm SQUARE EXTENSION SPINDLE
- (8) VALVE BOX TO BE PROTECTED AGAINST LATERAL MOVEMENT DURING BACKFILL
- (9) AWWA C500 or C509 GATE VALVE WITH JOINTS COMPATIBLE TO PIPE BEING USED. (FLANGED & PUSH ON ARE SHOWN)
- (10) GASKET
- (11) THRUST BLOCK SHALL BE CAST IN PLACE BETWEEN GATE VALVE AND UNDISTURBED SOIL. MIN 450W X 450L X 150H.
- (12) DUCTILE IRON COVER

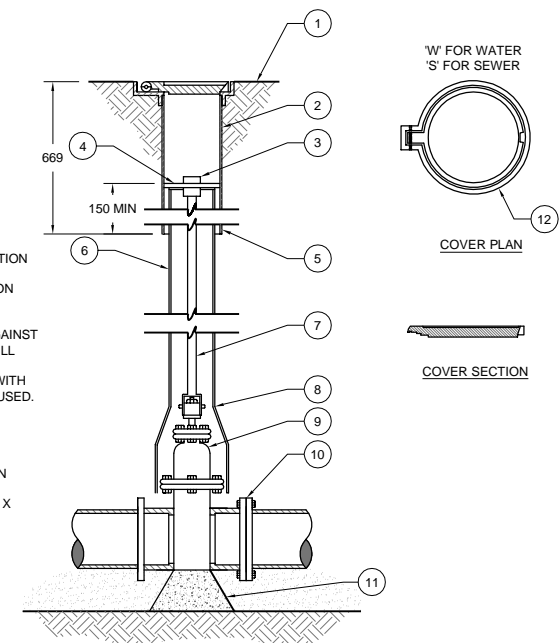

**GATE VALVE DETAIL**  
SCALE: 1:10

ID	DATE	APP.	BY	DESCRIPTION
1	APR 14, 2016	D.B.	J.K.	REVISIONS AS PER MB CONSERVATION COMMENTS
2	FEB 18, 2016	D.B.	J.K.	ISSUED WITH ENVIRONMENTAL ACT PROPOSAL
REVISIONS				

**APECM**  
Certificate of Authorization  
Burns Maendel Consulting  
Engineers Ltd.  
No. 4559 Expiry: April 30, 2017



DESIGNED BY: J.A.  
REVIEWED BY: D.B.  
DRAWN BY: J.K.  
PROJECT START DATE: DEC 2015  
PLOT SIZE: A1 (594x841)  
SCALE: AS NOTED

PROJECT NAME:  
**NEW ROSEDALE COLONY  
LAGOON DESIGN  
SE 21-18-11 WPM**

**BURNS MAENDEL  
CONSULTING ENGINEERS LTD.**  
1331 Princess Ave.  
Brandon, Manitoba  
R7A 0R4  
Tel: (204) 728-7364  
Fax: (204) 728-4418

DRAWING TITLE:  
**SECTIONS AND DETAILS**

PROJECT NUMBER: **BMCE14-166-36**  
DRAWING NO: **C3.2**

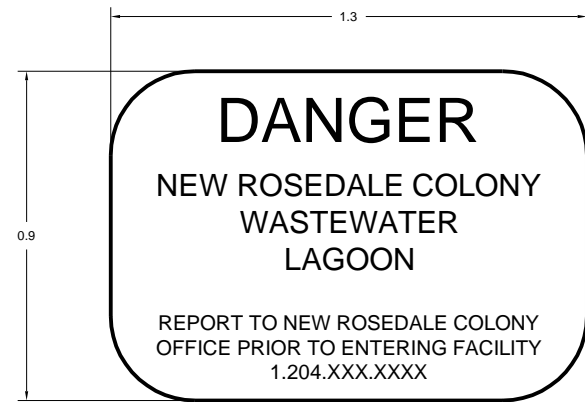

- NOTES:
- 1) MAIN ENTRANCE SIGNAGE TO BE ATTACHED AND INSTALLED WITH TWO 4x4 PRESSURE TREATED WOOD POSTS.
  - 2) SIGN TO BE CONSTRUCTED OF ALUMINUM AIR MASTER QUALITY OR APPROVED EQUAL.

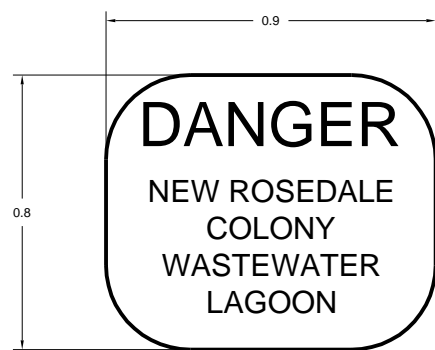

- NOTES:
- 1) PERIMETER SIGNAGE TO BE SECURED TO PERIMETER FENCE POSTS EVERY 50m AROUND ENTIRE FACILITY.
  - 2) SIGNS TO BE CONSTRUCTED OF ALUMINUM AIR MASTER QUALITY OR APPROVED EQUAL.

**SIGNAGE DETAILS**  
SCALE: 1:10

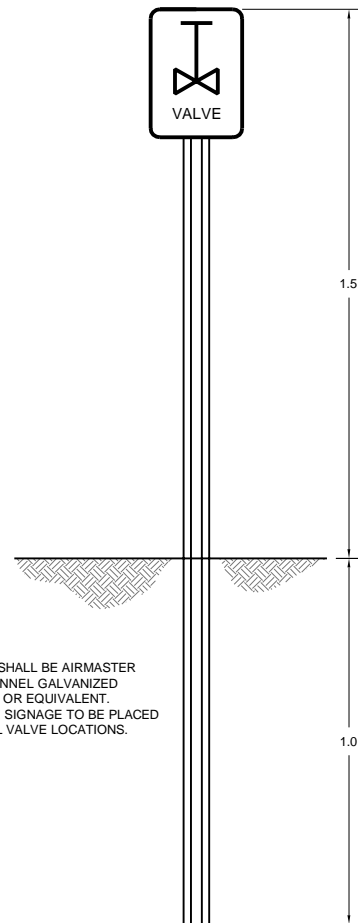

- NOTES:
- 1) POST SHALL BE AIRMASTER U-CHANNEL GALVANIZED STEEL OR EQUIVALENT.
  - 2) VALVE SIGNAGE TO BE PLACED AT ALL VALVE LOCATIONS.

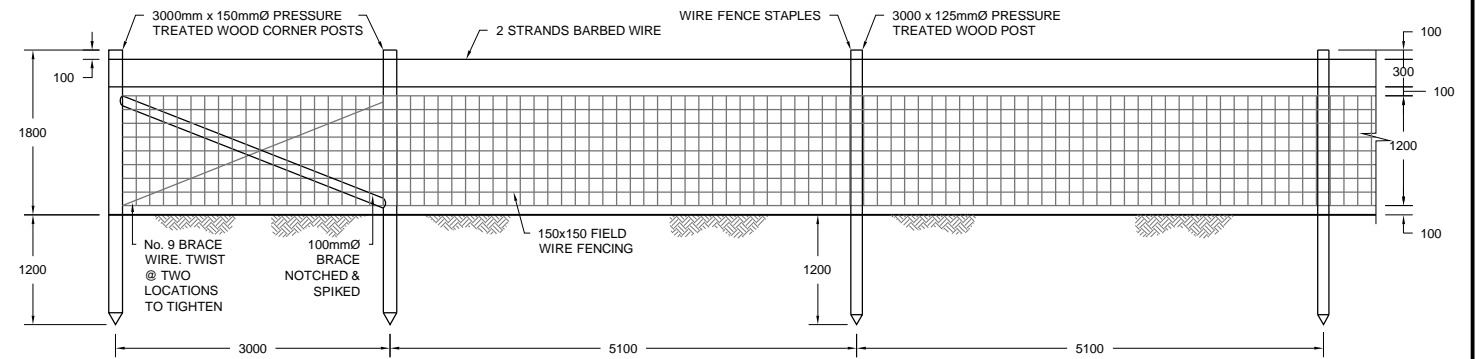

**PAGE WIRE FENCE DETAIL**  
SCALE: N.T.S.

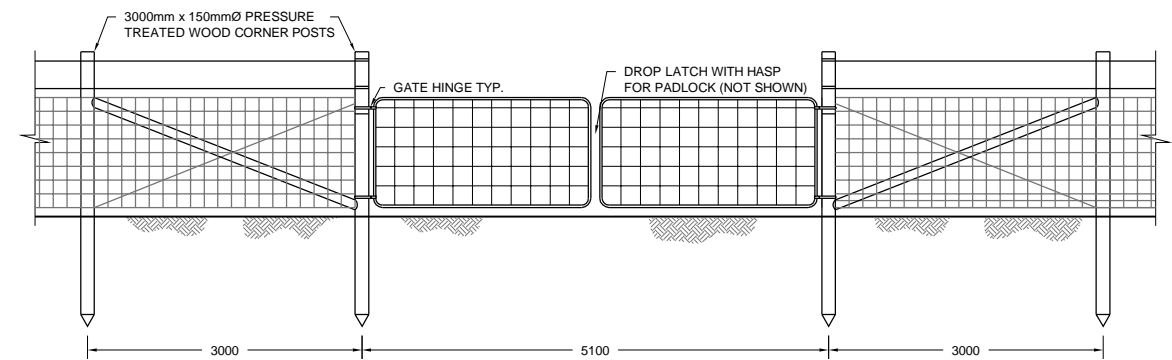

**PAGE WIRE FENCE GATE DETAIL**  
SCALE: N.T.S.

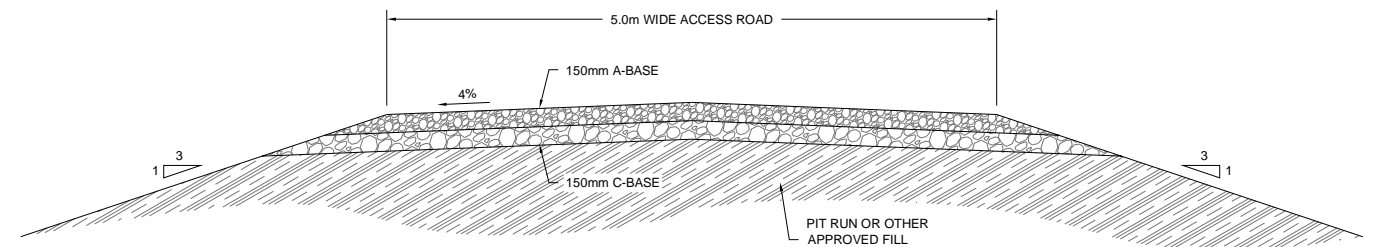

**TYPICAL ACCESS ROAD DETAIL**  
SCALE: 1:30

NO.	DATE	APP.	BY	DESCRIPTION
1	APR 14, 2016	D.B.	J.K.	REVISIONS AS PER MB CONSERVATION COMMENTS
2	FEB 18, 2016	D.B.	J.K.	ISSUED WITH ENVIRONMENTAL ACT PROPOSAL
REVISIONS				

**APEGM**  
Certificate of Authorization  
Burns Maendel Consulting  
Engineers Ltd.  
No. 4559 Expiry: April 30, 2017



DESIGNED BY: J.A.  
REVIEWED BY: D.B.  
DRAWN BY: J.K.  
PROJECT START DATE: DEC 2015  
PLOT SIZE: A1 (594x841)  
SCALE: AS NOTED

PROJECT NAME:  
**NEW ROSEDALE COLONY  
LAGOON DESIGN  
SE 21-18-11 WPM**

**BURNS MAENDEL  
CONSULTING ENGINEERS LTD.**  
1331 Princess Ave.  
Brandon, Manitoba  
R7A 0R4  
Tel: (204) 728-7364  
Fax: (204) 728-4418

DRAWING TITLE:  
**FENCING, SIGNAGE  
AND ROAD DETAILS**

PROJECT NUMBER: **BMCE14-166-36**  
DRAWING NO: **C3.3**



## Appendix B – Geotechnical Investigation

Submitted To: **Burns Maendel Consulting Engineers Ltd.**

**GEOTECHNICAL INVESTIGATION**

**NEW ROSEDALE COLONY  
MANITOBA**



**FEBRUARY 2016**

**FILE NO. 15-398-06**



***“Engineering and Testing Solutions That Work for You”***

6 - 854 Marion Street  
Winnipeg, Manitoba  
Canada  
R2J 0K4

Phone: (204) 233-1694  
Facsimile: (204) 235-1579  
e-mail: [eng\\_tech@mts.net](mailto:eng_tech@mts.net)  
[www.eng-tech.ca](http://www.eng-tech.ca)

## TABLE OF CONTENTS

	PAGE
<b>TABLE OF CONTENTS</b> .....	i
<b>1.0 INTRODUCTION</b> .....	1
1.1 Scope of Work .....	1
<b>2.0 TEST HOLE DRILLING, SOIL SAMPLING &amp; LABORATORY TESTING</b> .....	1
<b>3.0 STRATIGRAPHY</b> .....	3
<b>4.0 RECOMMENDATIONS</b> .....	4
4.1 General .....	4
4.2 Foundations .....	5
4.2.1 Driven End Bearing Pre-Stressed Concrete Piles (PPCP).....	5
4.2.2 Cast-in-Place Concrete Friction Piles .....	7
4.2.3 Footings .....	8
4.3 Concrete Slab-on-Grade Floors.....	9
4.4 Concrete Slab-on-Grade Basement Floors.....	10
4.5 Crawlspace.....	11
4.6 Drainage .....	11
4.7 Foundation Concrete .....	12
4.8 Proposed Lagoon.....	13
4.9 Proposed Sewer & Water Lines Installation.....	14
<b>5.0 CLOSURE</b> .....	14

### Attachments

Figure 1 – General Sites Location Plan

Figure 2 – Sites Location Plan

Figure 3 – Proposed Feed Mill Location Plan

Figure 4 – Proposed Feed Mill Test Hole Location Plan

Figure 5 – Proposed Residential Area Structures, Industrial Shops & Lagoon Location Plan

Figure 6 – Proposed Residential Area Structures & Industrial Shops Test Hole Location Plan

Figure 7 – Proposed Lagoon Test Hole Location Plan

Figure 8 – Hydraulic Conductivity Verses Elapsed time (TH15\_S5)

Table 4 – Hydraulic Conductivity Test Data

Modified Unified Classification System for Soils

Stratigraphic Test Hole Logs (20)

## 1.0 INTRODUCTION

ENG-TECH Consulting Limited (ENG-TECH) completed the requested geotechnical investigation at the New Rosedale Colony in Manitoba, which is east of Waldersee for a proposed feed mill and lagoon, and two (2) optional locations (north and south) for proposed residential area structures (including multiplex houses, kitchen/dining room building and school) and an industrial shop as shown in Figures 1 to 7. ENG-TECH was informed that the proposed single storey feed mill without a basement or crawlspace will be approximately 40 m by 30 m in plan. Proposed multiplex houses of timber frame construction with basements at both location options will be for 2 to 3 family units. At each optional location, the proposed single storey kitchen/dining room building of timber frame construction with a crawlspace will be approximately 90 m by 30 m in plan, the single storey school of timber frame construction with a crawlspace will be approximately 40 m by 20 m in plan, and the single storey industrial shop of timber frame construction without a basement or crawlspace will be approximately 140 m by 100 m in plan. The proposed lagoon will be approximately 20.5 m by 72.5 m in plan, consist of two (2) cells with the expected depths to vary from 0.7 to 1.6 m below existing grade. The proposed buildings are in the preliminary stage and the foundation design loads will not be determined prior to completion of the geotechnical report, and the proposed lagoon is also in the preliminary stage and the final design will not be determined until after the completion of the geotechnical report. The purpose of the geotechnical investigation was to assess the soil conditions within or close to the footprints of the proposed buildings and lagoon in order to provide design recommendations for the foundations of the proposed buildings, concrete slab-on-grade and basement floors, drainage and concrete durability, as well as recommendations whether the soil types encountered within the footprint of the proposed lagoon would be suitable for use in construction of the berm and liner for the lagoon, and construction recommendations on the feasibility of utilizing directional drilling/tunneling for installation of the water & sewer pipes.

### 1.1 Scope of Work

ENG-TECH completed the following scope of work:

- A test hole drilling and soil sampling program.
- A laboratory testing program.
- An assessment and engineering report outlining the investigation and recommendations as outlined above.

## 2.0 TEST HOLE DRILLING, SOIL SAMPLING & LABORATORY TESTING

ENG-TECH supervised the drilling of twenty (20) test holes (TH1FM to TH3FM and TH1 to TH17) at the New Rosedale Colony on December 1, 2 and 16, 2015 at locations shown on Figures 4, 6 and 7.

Four (4) test holes (TH1FM to TH3FM and TH12) were drilled using a truck mounted CME drill rig equipped with 125 mm diameter solid stem continuous flight augers, owned and operated by Subterranean (Manitoba) Ltd, while the remaining sixteen (16) test holes (TH1 to TH11 and TH13 to TH17) were drilled using a truck mounted CT250 drill rig equipped with 125 mm diameter solid stem continuous flight augers, owned and operated by Paddock Drilling Limited. All test holes were backfilled using the soil auger cuttings and bentonite upon completion of drilling.

The soil stratigraphy was visually classified at the time of drilling using the modified Unified Soil Classification System (USCS). Soil samples were collected off the auger flights and by means of Shelby tubes at depths of 3.0 m and 6.1 m in TH2FM and TH12, and 3.0 m in TH15, and by means of split spoons at 4.3 m in TH1, 3.4 in TH2, 2.7 m in TH4, 2.6 m in TH5, 2.7 m in TH7, 4.0 m in TH8, 5.5 m in TH9, 3.0 m in TH10, 2.4 m in TH11, 3.0 m in TH14, and 3.0 m in TH16. All soil samples collected were retained for testing in ENG-TECH's Winnipeg laboratory.

Moisture contents were determined on all collected samples (130), while one (1) unconfined compressive strength test, one (1) hydraulic conductivity test and nineteen (19) Atterberg limits were completed on select samples. The moisture content and Atterberg limits results are shown on the test hole summary logs, where as the hydraulic conductivity test data is shown on the Table 4 and hydraulic conductivity verses elapsed time is shown on Figure 8.

#### *Proposed Feed Mill*

Three (3) test holes (TH1FM to TH3FM) were within or close to the proposed feed mill as shown in Figure 4. TH1FM and TH3FM both were drilled to auger refusal which occurred at 12.8 m below existing grade on suspected dense till or boulders, while TH2FM was advanced to 10.7 m below existing grade.

#### *Proposed Industrial Shop (North Option)*

Two (2) test holes (TH1 and TH4) were within or close to the proposed industrial shop (north option) as shown in Figure 6. TH1 and TH4 were drilled to auger refusal at 4.3 m and 2.7 m below existing grade on suspected dense till or boulders, respectively. TH1 was advanced further to 4.7 m below existing grade with Standard Penetration Test (SPT) testing, and TH4 was advanced further to SPT refusal at 3.2 m below existing grade on suspected dense till or boulders.

#### *Proposed Residential Area Structures (North Option)*

Four (4) test holes (TH2, TH3 TH5, and TH6) were within or close to the proposed residential area structures (north option) as shown in Figure 6. TH2, TH3, TH5 and TH6 were drilled to auger refusal at 3.4 m, 4.3 m, 2.6 m and 4.0 m below existing grade on suspected dense till or boulders, respectively. Also, TH2 and TH5 were advanced further to 3.8 m and 3.0 m below existing grade with SPT testing.

#### *Proposed Industrial Shop (South Option)*

Two (2) test holes (TH9 and TH12) were within or close to the proposed industrial shop (south option) as shown in Figure 6. TH9 and TH12 drilled to auger refusal at 5.5 m and 7.6 m below existing grade on suspected dense till or boulders, respectively, while TH9 was further advanced to 5.8 m below existing grade with SPT testing.

#### *Proposed Residential Area Structures (South Option)*

Four (4) test holes (TH7, TH8 TH10, and TH11) were within or close to the proposed residential area structures (south option) as shown in Figure 6. TH7, TH8, TH10 and TH11 were drilled to auger refusal at 2.7 m, 4.3 m, 3.5 m and 2.4 m below existing grade on suspected dense till or boulders, respectively. Also, TH7, TH10 and 11 were advanced further to SPT refusal at 3.2 m, 3.5 and 2.9 m below existing grade, while TH8 was further advanced to 4.3 m below existing grade with SPT testing.

### *Proposed Lagoon*

Five (5) test holes (TH13 to TH17) were within or close to the proposed lagoon as shown in Figure 7. TH14 was drilled to auger refusal at 3.0 m below existing grade on suspected dense till or boulders, while TH13, TH15, TH16 and TH17 were advanced to 9.1 m, 9.1 m, 3.0 m and 3.0 m below existing grade, respectively. Also, TH14 and TH17 both were advanced further to 3.5 m below existing grade with SPT testing.

### **3.0 STRATIGRAPHY**

Frost was detected in the upper 50 to 300 mm of the test holes.

Detailed stratigraphy descriptions are outlined on the test hole summary logs.

### *Proposed Feed Mill*

The stratigraphy at TH1FM to TH3FM, which were the test holes within or close to the footprint of the proposed feed mill, consisted of 50 to 300 mm of gravel fill underlain by native glacial till to the depth explored, except at TH2FM and TH3FM where layers of 1650 mm thick native sand and 160 mm thick native clay were detected between the gravel fill and glacial till. The gravel fill was light brown, moist, frozen, poorly graded, fine to coarse grained, and contained some sand. The sand was light brown, moist to damp, poorly graded, fine to coarse grained and contained trace to some silt. The glacial till was tan to medium brown, moist, firm to very stiff, medium plastic and contained clay, silt, sand & gravel, and with depth became low plastic and soft, and then became grey to medium brown and stiff to very stiff before encountering auger refusal, except at TH2FM where the only low plastic glacial till was detected.

No seepage or sloughing was observed in TH1FM to TH3FM during the drilling.

### *North Option for Proposed Residential Area Structures and Associated Industrial Shop*

The stratigraphy at TH1 to TH6, which were the test holes within or close to the footprints of the proposed residential area structures (multiplex houses, a kitchen/dining room building and school) and the associated industrial shop for the north option, consisted of a 100 to 150 mm of topsoil underlain by native glacial till to the depth explored. The topsoil was dark brown, moist, frozen and contained organic. The glacial till was light to medium brown, moist, stiff to very stiff, low plastic and contained clay, silt, sand & gravel, and with depth became hard, except at TH5 where the upper 1.2 m of the glacial till was soft.

No seepage or sloughing was observed in TH1 to TH6 during the drilling.

### *South Option for Proposed Residential Area Structures and Associated Industrial Shop*

The stratigraphy at TH7 to TH12, which were the test holes within or close to the footprints of the proposed residential area structures (multiplex houses, a kitchen/dining room building and school) and the associated industrial shop for the south option, consisted of a 100 to 150 mm of topsoil underlain by native glacial till to the depth explored. The topsoil was dark brown, moist, frozen and contained organic. The glacial till was light to medium brown, moist, stiff to very stiff, low plastic and contained clay, silt, sand & gravel, and with depth became hard.

No seepage or sloughing was observed in TH7 to TH12 during the drilling.

### *Proposed Lagoon*



The stratigraphy at TH13 to TH 17, which were the test holes within or close to the footprint of the proposed lagoon, consisted of 100 to 150 mm of topsoil underlain by glacial till to the depth explored, except at TH15 where an 1.1 m thick native silt layer over an 800 mm thick clay layer was detected between the topsoil and glacial till, and also where an additional 2.9 m thick silt layer was interbedded deeper within the glacial till. Also at TH16 and TH17 a 2.0 m and 1.1 m thick native silt layer were detected between the topsoil and glacial till, respectively. The topsoil was dark brown, moist, frozen and contained organics. The glacial till was light medium brown, moist, firm to hard, low plastic, and contained clay, silt, sand gravel, and with depth became medium brown to grey. The clay was light brown, wet, soft, low plastic, and contained some silt and trace to some sand. The silt was tan, wet, soft, low plastic and contained trace to some sand, except the deepest silt layer at TH15 where the silt was tan to light brown and additionally contained trace gravel.

Seepage and sloughing were observed from the silt and/or clay layers in TH15 to TH17 during drilling. No seepage or sloughing was detected at TH13 and TH14.

## **4.0 RECOMMENDATIONS**

### **4.1 General**

The Department of Highways (specification 900) aggregate grading specifications should be used for the sub-base and base materials specified in this report.

#### *Proposed Feed Mill*

Based on the soil conditions and the magnitude of typical loads for a feed mill, a deep foundation such as pre-stressed pre-cast concrete end bearing piles driven to refusal within the hard glacial till would be suitable to limit settlement and differential movement.

If preferred, another deep foundation such as cast-in-place concrete friction piles could be considered suitable to limit settlement and differential movement for the smaller loads associated with the feed mill. The reduced consideration of the cast-in-place concrete friction pile is due to randomly encountering soft soils with low skin friction resistance values within the glacial till, however cast-in-place concrete friction piles may be more economical than driven piles for the smaller loads.

Shallow foundations for the feed mill, such as footings, were not considered as viable options due to the potential for movements resulting from encountering random soft wet glacial till within the zone of influence of any footing installed.

Other foundation types could also be used to support the proposed feed mill, although they were not considered as practical or economical as the above options. Therefore, only foundation recommendation for pre-stressed pre-cast concrete end bearing piles driven to refusal within the till and cast-in-place concrete friction piles will be presented for the feed mill in this report.

### *Proposed Residential Area Structures and Industrial Shop for North and South Options*

Based on the soil conditions and the magnitude of typical loads for the proposed single storey residential area structures (multiplex houses, a kitchen/dining room building and school) and the single storey industrial shop of both options (north and south), deep foundations such as cast-in-place concrete friction piles would be suitable to limit settlement and differential movement. Construction difficulties associated with drilling to design designs should be expected in the some of the boreholes during the installation of cast-in-place concrete friction piles since auger refusal was encountered as shallow as approximately 2.5 m below grade during drilling for the north and south options.

A shallow foundation such as footings would likely be more economical to install than deep piles, however shallow foundations are more prone to vertical and differential movement than piles. Shallow foundations, such as footings would be suitable to support the proposed residential area structures and the industrial shop providing the owner is willing to accept the risk of differential movements typical for footings using the recommended bearing capacities. The expected differential movements are usually half of the total movements.

ENG-TECH cautions that with shallow foundations such footings, there is an increased potential for movements resulting from changes in soil moisture content or frost jacking. These movements can be minimized with adequate sub-grade preparation and site drainage, as well as foundation insulation for heated structures. Portions of the soil near grade are frost susceptible, and the amount of heave due to frost will depend on the amount of moisture at the time of freezing. In addition, movements associated with the shrinkage and swelling of clay soil due to a change in moisture content should be expected with shallow foundations. Adequate drain must be maintained near footings to prevent soil swell.

Other foundation types could also be used to support the proposed residential area structures (multiplex houses, a kitchen/dining room building and school) and the industrial shop of both options (north and south), although they were not considered as practical or economical as the above options. Therefore, only foundation recommendations for cast-in-place concrete friction piles and footings for the proposed residential area structures and industrial shop for both options (north and south) will be presented in this report.

## **4.2 Foundations**

### **4.2.1 Driven End Bearing Pre-Stressed Pre-Cast Concrete Piles (PPCP)**

The pile capacities for standard hexagon PPCP sizes when driven to practical refusal within the underlying very stiff to hard till were assessed for the feed mill using a geotechnical resistance factor of 0.4 to obtain the Ultimate Limit State (ULS) and Serviceability Limit State (SLS) values outlined below in Table 1. The depth to auger refusal within the till was 12.8 m below existing grade during the test hole drilling program for the feed mill, however auger refusal depths can vary across the footprint of the feed mill. Therefore, it is advisable to drive a few test piles to establish the most economical pile length to order before ordering the remainder of the piles.

<b>Table 1</b> <b>ULS and SLS Capacities for Static,</b> <b>Vertical Driven Pre-Stressed Pre-Cast Concrete Piles for Feed Mill</b>					
Pile Diameter		ULS Capacity	SLS Capacity	Blows per 25 mm of Pile Penetration	Energy per Blow
mm	Inch	kN	kN		kJ
305	12	500	400	5	40
356	14	750	600	8	40
406	16	1,000	800	12	40

The following recommendations also pertain to the use of driven PPCP:

- All piles must refuse within the very stiff to hard till. Refusal is defined as a penetration of 25 mm or less per set of blows consisting of the quantity outlined above for 3 successive sets. If sudden refusal occurs (very little or no penetration per set of blows) driving should cease and the capacity of the pile should be assessed by ENG-TECH.
- The pile driving hammer must be capable of delivering the required energy per blow on a continuous basis.
- All piles must be driven continuously to the above refusal criteria once driving is initiated.
- To protect against pile damage and misalignment during driving, the driving energy of the hammer should initially be reduced to approximately 10 kJ, and then gradually increased as the pile penetrates with depth in the native clay deposit. Pre-boring a pilot hole the same diameter as the pile to a depth of 6 m can be conducted to aid in pile alignment.
- Piles in groups should be installed a minimum spacing of three (3) pile diameters apart from each other. For a two (2) pile group the capacity per pile as outlined above could be used to establish the capacity of the group.
- Inspection and documentation should be completed by ENG-TECH during pile driving on a full time basis. All piles should be monitored for heave during and subsequent to driving, and all piles which have heaved must be re-driven to meet the above criteria. The contractor should not establish final elevation of the piles (cut piles) until monitoring for heave has been completed. The pile capacities outlined herein should be approved upon completion of pile driving.
- If a steel follower (chaser) is required to drive piles where the top of the pile advances below grade during driving, then the refusal criteria shall be 7, 10 and 15 blows per 25 mm of pile penetration for 305, 356 and 406 mm diameter piles, respectively.
- A minimum compressible void form that does not transfer load to the foundation walls of 150 mm must be maintained under all pile caps, foundation walls, and grade beams.

#### 4.2.2 Cast-in-Place Concrete Friction Piles

Cast-in-place concrete friction piles were assessed for the proposed feed mill and residential structures using a geotechnical resistance factor of 0.4 to obtain the ULS and SLS values that can be used in design. Outlined in Table 2 below are the vertical resistance for the feed mill, and in Table 3 for the residential area structures (multiplex houses, a kitchen/dining room building and school) and industrial shop.

<b>Table 2</b>		
<b>ULS and SLS Skin Friction Static Resistances for Cast-In-Place Concrete Piles for Feed Mill</b>		
<b>Depth Range (m)</b>	<b>ULS Skin Friction Resistance</b>	<b>SLS Skin Friction Resistance</b>
	<b>kPa</b>	
The greater of: 2.5 m below existing grade or 1.0 m below the underside of the grade beam	0	0
Between the above and 4.5 m below existing grade	18	15
Between the above and 9.5 m below existing grade	10	8
Between the above and 12.0 m below existing grade	18	15

<b>Table 3</b>		
<b>ULS and SLS Skin Friction Static Resistances for Cast-In-Place Concrete Piles for Residential Area Structures and Industrial Shop (North and South Options)</b>		
<b>Depth Range (m)</b>	<b>ULS Skin Friction Resistance</b>	<b>SLS Skin Friction Resistance</b>
	<b>kPa</b>	
The greater of: 2.5 m below existing grade or 1.0 m below the underside of the grade beam	0	0
Between the above and 12.0 m below existing grade	18	15

The following recommendations also apply to the use of cast-in-place concrete friction piles:

- The piles should be spaced at least 2.5 pile diameters apart, as measured from center to center in order to have the piles act individually. For a two (2) pile group, the capacity per pile as outlined above could be used to establish the capacity of the group.
- A minimum embedment depth of 7 m must be used for all piles located within the proposed feed mill, kitchen/dining room buildings and schools, and within and on the basement perimeter of multiplex houses. Also, a minimum embedment depth 8 m must be used for all piles located on the perimeter of the proposed feed mill, kitchen/dining room buildings and schools, and in unheated areas.

- The piles may be treated as supported columns throughout their depth below final grade.
- The weight of the embedded portion of the pile may be neglected in the design, when determining the load on a pile.
- Each pile must be reinforced to at least 6 m, with reinforcement to resist up-lift pressures due to structural forces as determined by the structural engineer. The design of piles to resist up-lift from soil swell pressure is not required for all piles since significant differential changes in moisture content are not expected around the piles with depth. Vertical reinforcement may also be required to resist breaking of the upper portion of the piles as a result of up-lift forces due to frost action against perimeter piles and piles in unheated areas. The use of a Sona tube wrapped with a layer of 4 mil poly and inserted in the upper 3.0 m of the bore holes prior to placement of concrete will aid to reduce the potential of uplift pressures on the piles due to frost for all piles in unheated areas.
- The piles should be poured immediately after the completion of drilling to reduce the potential for seepage in the boreholes, and sloughing, swelling and squeezing of the boreholes, and should be poured in accordance with Clause 7.2.7 of the Canadian Standards Association A23.1-14 (Concrete Materials and Methods of Concrete Construction). Seepage and sloughing should be expected from the soft wet silt or clay layers as randomly encountered during the drilling program for the lagoon, and should be expected in some of the boreholes during the installation of cast-in-place piles. Steel sleeving varying in length (including to full length) may be required for some piles, while pumping may be required to remove excess water from some boreholes prior to pouring the concrete. Sleeving & a pump should be available on site and used on an as required basis.
- A minimum void space of 150 mm should be maintained under all pile caps, grade beams, and structures supported on piles to prevent damage due to uplift pressures and potential swelling of the underlying soils, should it occur.

#### 4.2.3 Footings

Both the interior square and perimeter strip footings can be founded on the firm to very stiff native glacial till for the proposed residential area structures and industrial shops between 0.5 to 2.5 m below existing grade, except to support the proposed north proposed kitchen/dining room building in the vicinity of TH5 where soft soils were detected in the upper 1.2 m of TH5 and the footings (interior square and perimeter strip) can be founded on the firm to very stiff native glacial till between 1.2 m to 2.5 m below existing grade.

The interior square footings can be designed using a ULS bearing pressure of 270 kPa and a (SLS) bearing pressure of 180 kPa, while the perimeter strip footing can be designed using a ULS bearing pressure of 225 kPa and a SLS bearing pressure of 150 kPa. The footings were assessed using a geotechnical resistance factor of 0.5 to obtain the ULS and SLS values that can be used in design. The footings cannot be founded on topsoil or soft soils since excessive total settlements and differential movements can occur. The strip footing must be no less than 0.61 m wide, while the square footings must not be less than 0.75 m or greater than 1.5 m wide. The footings must be spaced no less than 1.5 m apart as measured from edge to edge. The above will aid in minimizing movement of the footings.

ENG-TECH cautions that with shallow foundations such as footings, there is an increased potential for movements resulting from changes in soil moist content or frost jacking, however these movements can be minimized with adequate sub-grade preparation and site drainage. The design of the foundations to maintain settlements less than 25 mm would require the base of the footings be prepared as outlined below:

- Remove all topsoil, native vegetation and soft soils to their full depth. Excavate the area of the proposed footings with an additional 0.2 m width on each side of the footings to 100 mm below the underside of the footings design elevations. The exposed sub-grade will consist of firm to very stiff glacial till.
- The excavated clayey soil may be suitable to re-use as backfill and can be temporarily stockpiled a minimum of 3.0 m away from the excavation. Stockpiled excavated soil must be approved by ENG-TECH for re-use as backfill prior to placement. All organic and soft soils (including silt) could be used in vegetated landscaped areas
- Hard compact the exposed sub-grade in order to decrease the voids created during excavating. The sub-grade should be inspected by ENG-TECH prior to placement of any base material. Instructions for dealing with soft spots will be provided after inspection.
- Place +/- 100 mm of either granular or limestone base course in a single lift and compact it to 100% of Maximum Dry Density (MDD) at  $\pm 2\%$  of optimum moisture content (ASTM D 698) to the underside of the footing design elevation.
- The base of the footings should be protected from inundation and drying prior to placement of the base material and concrete.

Rigid high density Styrofoam insulation should be placed on top of the perimeter strip footing and extend outwards a distance of 1.2 m to minimize the potential of frost penetration under the footings. The amount of insulation on top of footings will depend on the final soil cover. At this site in order to protect from frost action, the use of 25 mm Styrofoam insulation to represent 0.3 m of soil cover will suffice in areas where the soil cover will be less than 1.8 m thick as measured from the top of the footings to the final grade design elevation.

#### **4.3 Concrete Slab-on-Grade Floors**

ENG-TECH cautions that some movement of the slab should be expected and is typical for the slab-on-grade floors for the proposed industrial shop for both options (north and south), and the proposed feed mill. The above can be minimized with sub-grade preparation and the use of a well graded compacted base material. If typical movements are not acceptable to the owner, ENG-TECH recommends floors structurally supported on piles be used. Based on the above and providing the owner is willing to accept the possibility of movement of the slabs in the order of 50 mm, the slabs could be constructed as follows:

- Remove all topsoil, vegetation, organics and soft soils from the surface to their full depth within the footprints of the proposed feed mill, as well as the industrial shop for both options (north and south). Continue to excavate as required in order to achieve a minimum depth of 200 mm below the base of the slabs design elevation. The exposed sub-grade at the base of the excavation should consist of firm to very stiff glacial till and must be free of organic content.

- Uniformly compact the upper 300 mm of the sub-grade to 98% of its MMD at  $\pm 2\%$  optimum moisture content. If soft spots are encountered sub-excavate 300 mm and backfill using medium to highly plastic inorganic clay in two lifts with each lift compacted to a minimum of 98% of its MDD at  $\pm 2\%$  of optimum moisture content. The subgrade should be inspected by ENG-TECH prior to the placement of any base material.
- If required place medium to highly plastic inorganic clay (including clay fill) in maximum 150 mm thick lifts to 200 mm below the base of the slabs, and compact each lift to 98% MDD at  $\pm 2\%$  optimum moisture content.
- Place a 200 mm thick lift of granular or limestone base course and uniformly compact it to 100% MDD immediately below the base of the slabs.
- Place a minimum 6 mil poly layer on top of the granular base directly under the slabs.

The floor slabs should be continuously reinforced and be provided with joints at regular intervals to control and reduce random cracking and to prevent faulting. All partition walls or equipment founded on the slabs must have a minimum 75 mm thick void space at the top to prevent damage if the slab should heave. The slabs should be structurally separated from the grade beams and columns.

#### **4.4 Concrete Slab-on-Grade Basement Floors**

The concrete slab-on-grade basement floors for the multiplex houses will be founded on the firm to very stiff native glacial till subgrade, and if the glacial till were to swell in the presence of excess moisture, heave and associated movement of the slab can occur. Movement associated with shrinkage or swelling of the soils due to changing moisture content is expected, however this can be minimized with proper sub-grade preparation and the use of a free draining base material. If potential movement of the floors are unacceptable then concrete or wood floor systems structurally supported over a void space should be installed. Based on the above, and providing the owner is willing to accept the possibility of some movement of the floors, they could be constructed as follows:

- Remove all topsoil, organics, silt, and soft soils from the surface to their full depth within the footprint of the proposed basements, and continue to excavate as required to at least 150 mm below the underside of the basement floor design elevations. The sub-grade soils should consist of inorganic firm to stiff clay and should be shaped such that it continuously slopes towards a sump pit(s).
- Uniformly compact the upper 300 mm of the sub-grade to 95% of its MDD at  $\pm 2\%$  of optimum moisture content (ASTM D 698) in order to densify and decrease the voids created during excavating. If soft spots are encountered sub-excavate 300 mm and backfill using medium to highly plastic inorganic clay (including clay fill) in two lifts with each lift compacted to a minimum of 95% of its MDD at  $\pm 2\%$  of optimum moisture content. The sub-grade should be inspected by ENG-TECH prior to the placement of any base material.
- Place at least 150 mm of pea gravel and moderately vibrate it to reduce voids and future floor movements.

- Place a vapour barrier consisting of a minimum of 10 mil poly directly below the underside of floors.

The floors should be continuously reinforced and should be provided with joints at regular intervals to control and reduce random cracking and to prevent faulting. All partition walls or equipment founded on the slabs should have a minimum 75 mm thick void space at the bottom or top to prevent damage if the floors should heave. The floors should be structurally separated from the foundation walls and columns.

#### **4.5 Crawlspace**

The placement of a layer of 6 mil poly on the ground surface followed by the placement of 50 to 75 mm thick layer of lean concrete (typically 5 MPa) or sand within the area of the crawlspaces of the school and kitchen/dining room building would be acceptable. Any organics and soil with organics must be removed from within the crawlspace prior to placement of the poly.

#### **4.6 Drainage**

Proper surface drainage is essential to reduce the potential of frost action, and to reduce excess moisture adjacent the foundations. Medium to highly plastic clay soils should be used to raise the site adjacent the proposed structures in landscaped areas to achieve proper drainage away from the structures. Surface drainage should be controlled by ensuring a minimum grade away from the proposed structures of 5% for well compacted surface soils and 2% for paved surfaces for a minimum distance of 3 m. Runoff from the roofs of the proposed structures should be directed a minimum distance of 3 m from the perimeter of the foundations to reduce the potential of excessive moisture near the foundation.

In addition, a perimeter sub-drainage system (weeping tiles) around the basements of the proposed multiplex houses, as well as the crawlspaces of the school and kitchen/dining Room building will be required to aid in the removal of excess moisture. The weeping tiles will need to be directed to a sump pit and the water discharged as far as possible from the each proposed multiplex house, as well as the school and kitchen/dining Room building. The top of the perimeter perforated weeping tiles must be located below the base of the footings and void forms if the walls are supported on piles. Also, the lead pipes from the perimeter perforated pipes should be carved into the glacial till sub-grade and discharge into the sump pit rather than just placing them on the sub-grade at each proposed multiplex house, as well as the school and kitchen/dining Room building. Addition perforated lines not connected to the perimeter weeping tiles should be installed in the sub-grade and connected to the sump pit proposed at each multiplex house, as well as the school and kitchen/dining Room building. The above will aid to prevent excess moisture changes in the sub-grade which leads to shrinking and swelling and ultimately movement of the footings and basement floors.



## 4.7 Foundation Concrete

### General

All concrete should be designed, specified, and constructed in accordance with CSA standard A23.1-14, Concrete Materials and Methods of Concrete Construction using the Performance Specification Alternative as outlined in Table 5 of CSA A23.1-14.

Under the performance alternative, the concrete supplier shall assume responsibility for the performance of the concrete as delivered and the contractor shall assume responsibility for the concrete in place. The owner shall specify performance requirements including: the required structural criteria and concrete strength at age, the concrete exposure class for durability, and any other properties that may be required to meet the owner's performance requirements such as colour, architectural requirements, and special surface finishes. The owner reserves the right to request the supplier provide satisfactory documentation that the proposed mix design will achieve the strength, durability, and performance requirements specified by the owner, and that the mix design satisfies the requirements of CSA A23.1-14. In addition, the owner may request the contractor submit documentation demonstrating the owner's performance requirements have been met during construction and placement.

Based on Tables 1, 2, 3, and 4 of CSA A23.1-14, the concrete in contact with the local soils can be classified as a S-2 exposure class (severe sulphate exposure) for the piles and pile caps, a F-2 exposure class for the grade beams, a C-2 exposure class for the industrial shops floor slabs which may be exposed to chlorides with freezing and thawing, and a N exposure class for the slab-on-grade and basement floor slabs, which will be heated to maintain a continuous inside air temperature above freezing and not be exposed to chlorides. The concrete design can be selected as structurally required by design however the concrete should be designed to meet the minimum specifications outlined below for durability.

### Piles and Caps (S-2)

56 day minimum compressive strength of 32 MPa  
Maximum water/cementing materials ratio of 0.45  
Maximum nominal aggregate size of 20 mm  
Type HS or HSb cement  
Air content of 4-7%

### Grade Beams (F-2)

28 day minimum compressive strength of 25 MPa  
Maximum water/cementing materials ratio of 0.55  
Maximum nominal aggregate size of 20 mm  
Type Gu or Gub cement  
Air content of 4-7%

### Industrial Floor Slabs (C-2)

28 day minimum compressive strength of 32 MPa  
Maximum water/cementing materials ratio of 0.45  
Maximum nominal aggregate size of 20 mm  
Type Gu or Gub cement  
Air content of 5-8%

### Basement Floor Slabs (N)

28 day minimum compressive strength of 25 MPa  
Maximum water/cementing materials ratio of 0.55  
Maximum nominal aggregate size of 20 mm  
Type Gu or Gub cement  
Air content – natural

### **4.8 Proposed Lagoon**

Suitable soils of one (1) meter thick or construction of one (1) meter thick liner for a lagoon should be medium to highly plastic clay free from organics, which must be capable of having a hydraulic conductivity value of  $1 \times 10^{-7}$  cm/sec or less when:

- Naturally in place conforming to the design of the lagoon;
- Or, when remoulded and compacted.

The soil stratigraphy in the upper 9.1 m within or close to the proposed lagoon location was visually classified as topsoil, glacial till, clay or silt. All the soil types encountered within or close to the lagoon footprint were visually assessed to be low plastic with the topsoil additionally organic. The proposed location for the lagoon footprint is shown in Figures 1, 2, 5 and 7.

Atterberg Limits tests were conducted in accordance with the current ASTM Standard (D 4318 method A) on selected soil samples and the results showed that the glacial till within or close to the proposed lagoon was low plastic.

ENG-TECH selected a Shelby tube sample from TH15 at 3.0 m below grade, which was considered to be representative of the glacial till within and close to the proposed the lagoon, and prepared the sample in accordance with ASTM D5084-03, *Standard Test Method for Measurement of Hydraulic Conductivity of Saturated Porous Materials using a Flexible Wall Permeameter*. The final hydraulic conductivity value ( $k_{20}$ ) of  $1.2 \times 10^{-7}$  cm/sec was obtained for the sample, which was greater than the clay liner lagoon requirement (too porous). The hydraulic conductivity test data is outlined in Table 4, while the graphical representation of the hydraulic conductivity versus elapsed time is shown in Figure 8. Remolding and compaction may improve the hydraulic conductivity of the low plastic glacial till enough to satisfy the lagoon liner hydraulic conductivity criterion, however this may still yield marginal results, therefore several samples from the proposed lagoon site should be remoulded and tested before final design.

The silt encountered within or close to the lagoon will have higher hydraulic conductivity values than the tested glacial till. Also, silt was detected immediately below the topsoil at TH15 to TH17 during the drilling program and should be expected randomly at shallow depths within the footprint of the proposed lagoon.

Based on the field observation and laboratory results, an artificial liner may be required for a lagoon at the proposed location as shown in Figures 1, 2, 5 and 7.

#### 4.9 Proposed Sewer & Water Line Installation

Directional drilling can be hindered by the presence of gravel and/or boulders, which causes unexpected random deflections. This will have less of an impact on the water lines since the water line is under pressure, and maintaining a constant gradient of the water line has less of an impact than on a gravity flow sewer line. Auger refusal was encountered as shallow as approximately 2.5 m below grade during drilling for the north and south options, which would indicate the presence of cobbles and boulders, as such it would be expected that if an obstruction were to take place during directional drilling, then excavation at the obstruction location most likely will be required to remove the obstruction before continuing to drill.

Tunnelling may not be a viable option when the soils tunnelling through or the soil directly above the tunnelling zone are soft, wet and/or sloughing and not homogeneous along the proposed installation route of the water and/or sewer lines. Extensive soft conditions were detected prior to auger refusal during the drilling for the proposed feed mill. Also, tunnelling would not be considered a viable option when cobbles or boulders are encountered in the soils, and auger refusal was encountered as shallow as approximately 2.5 m below grade during drilling for the north and south options, which would indicate the presence of cobbles and boulders. Soft soils and/or the presence of boulders occurred during the drilling program for feed mill, residential area structures and industrial shop.

Open trenching would be a most suitable option for installation of water & sewer lines on the colony.

#### 5.0 CLOSURE

This report was based on the scope of work outlined for the purpose of the investigation, and was prepared in accordance with acceptable professional engineering principles and practices. If you have any questions, please contact the undersigned.

Sincerely,  
ENG-TECH Consulting Limited

*Rodney L Girouard*

Rod Girouard, P.Eng.  
Geotechnical Engineer

CDH/rig



*Clark Hryhoruk*

Clark Hryhoruk, M.Sc., P.Eng.  
Principal, Geotechnical Engineer

**LEGEND**

- PR = PROVINCIAL ROAD
- HWY = HIGHWAY
- RESAS = RESIDENTIAL AREA STRUCTURES
- ISHOP = INDUSTRIAL SHOP

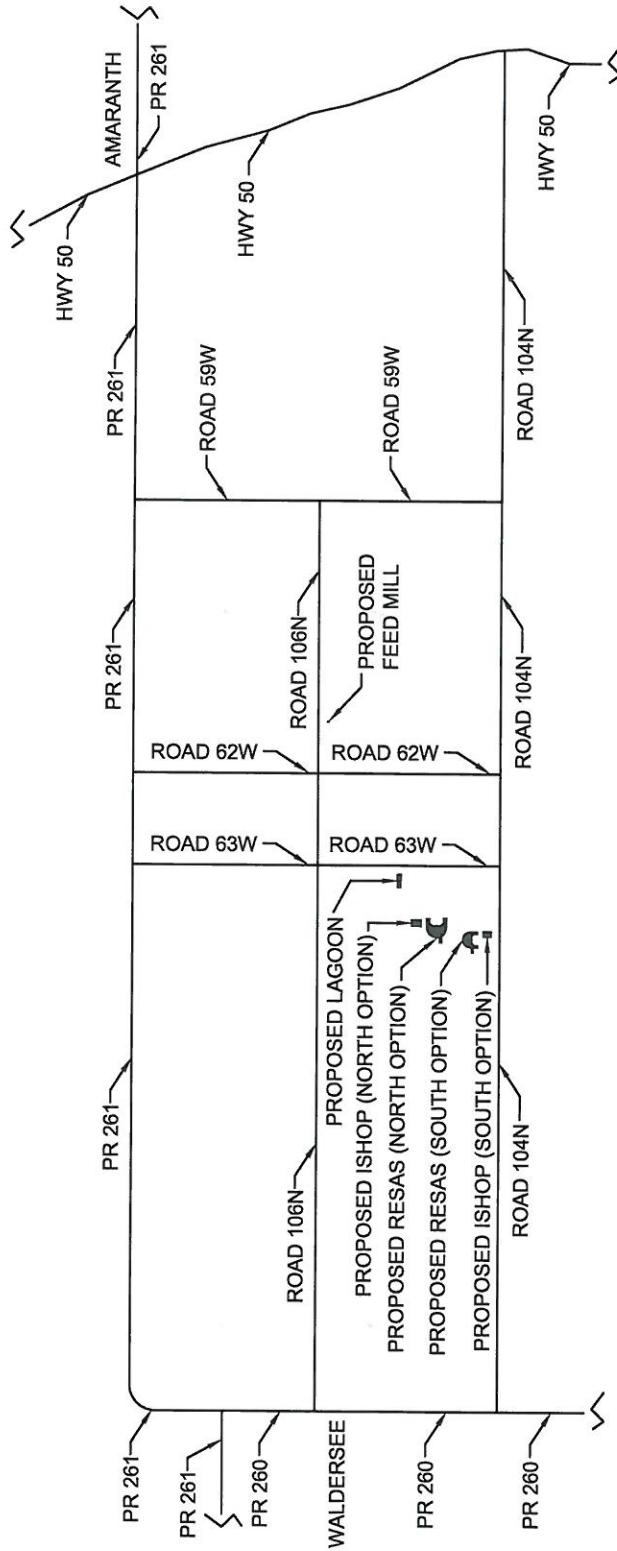
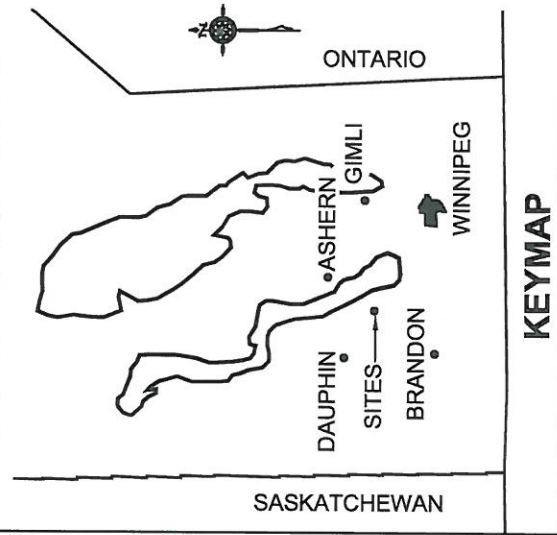

NO.	DATE	ISSUE / REVISION
0	Jan 2016	report

6 - 854 Marion Street  
Winnipeg, MB R2J 0K4  
Phone: (204) 233-1694  
Fax: (204) 235-1579

**ENG-TECH CONSULTING LIMITED**

ENG. STAMP:

**APEGN**  
Certificate of Authorization  
ENG-TECH Consulting Limited  
No.2475 Expiry: April 30, 2016

CLIENT:  
BURNS MAENDEL CONSULTING ENGINEERS LTD.

PROJECT:  
GEOTECHNICAL INVESTIGATION - NEW ROSEDALE COLONY, MANITOBA

DWG DESCRIPTION:  
GENERAL SITES LOCATION PLAN

SCALE:  
AS SHOWN

DRAWN BY:  
RLG

DATE:  
JANUARY 2016

FILE NO.:  
15-398-06

CLIENT DWG/FIG. NO.:

ENG-TECH DWG/FIG. NO.:

NO.:

**LEGEND**

RESAS = RESIDENTIAL AREA  
STRUCTURES  
ISHOP = INDUSTRIAL SHOP

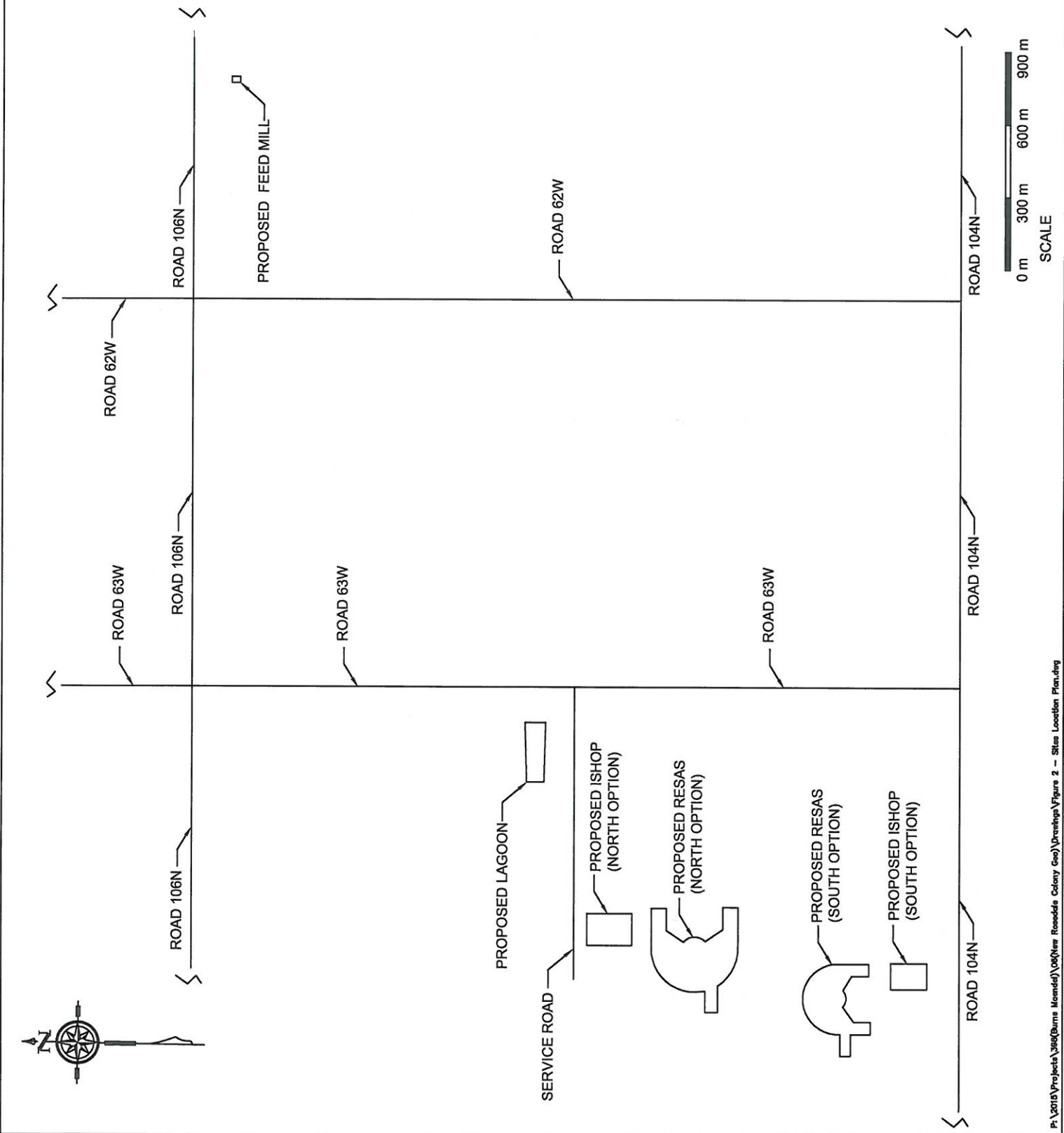

NO.	DATE	ISSUE / REVISION
0	Jan 2016	report

6 - 854 Marlon Street  
Winnipeg, MB R2J 0K4  
Phone: (204) 233-1694  
Fax: (204) 235-1579



ENG. STAMP:



CLIENT:  
BURNS MAENDEL CONSULTING  
ENGINEERS LTD.

PROJECT:  
GEOTECHNICAL INVESTIGATION -  
NEW ROSEDALE COLONY,  
MANITOBA

DWG DESCRIPTION:  
SITES LOCATION PLAN

SCALE:	AS SHOWN
DRAWN BY:	RLG
DATE:	JANUARY 2016
FILE NO.:	15-398-06
CLIENT DWG/FIG. NO.:	
ENG-TECH DWG/FIG. NO.:	
NO.:	2

**LEGEND**

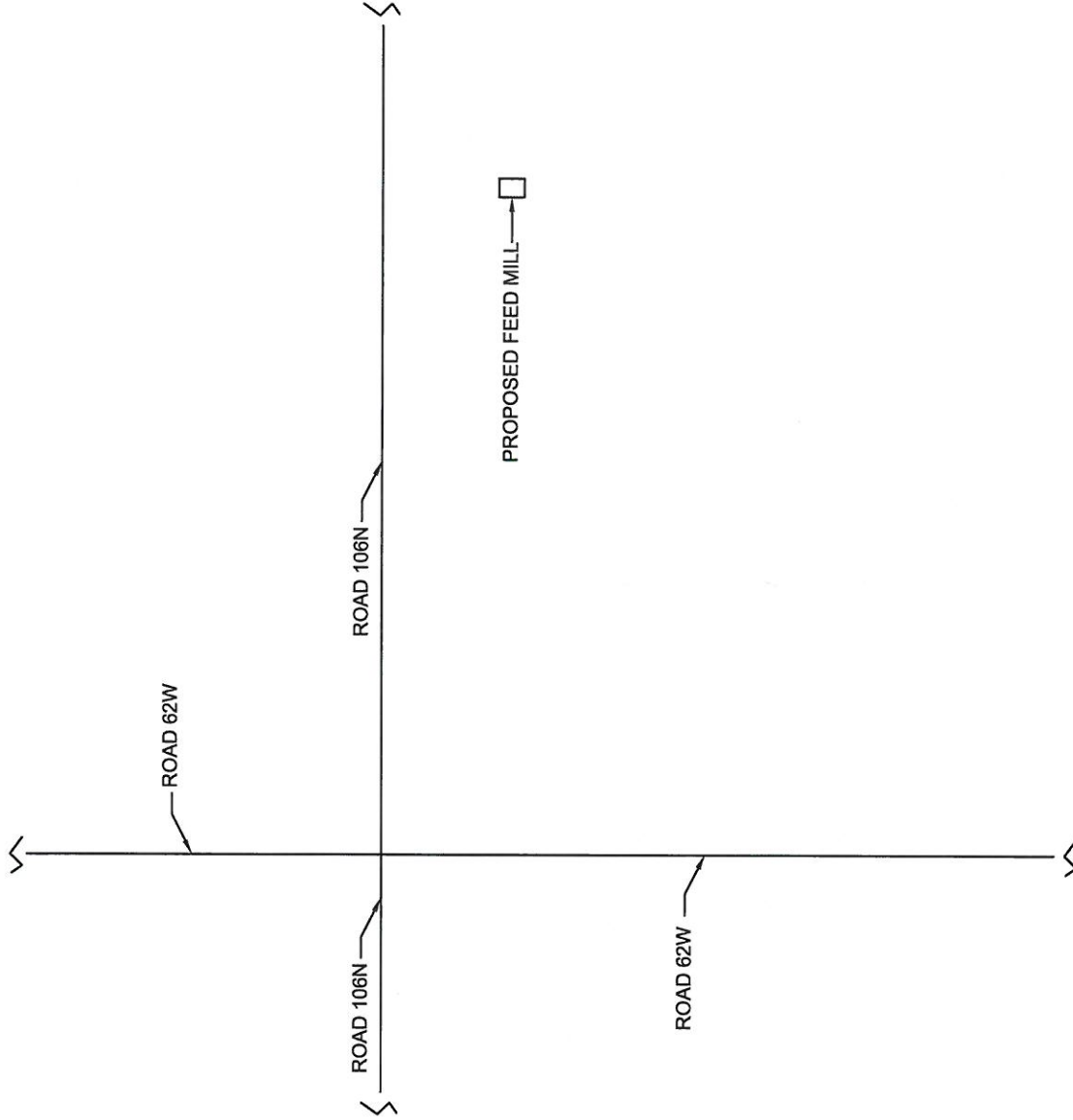

NO.	DATE	ISSUE / REVISION
0	Jan 2016	report

**ENG-TECH**  
CONSULTING LIMITED

6 - 854 Marion Street  
Winnipeg, MB R2J 0K4  
Phone: (204) 233-1694  
Fax: (204) 235-1579

ENG. STAMP:

**APEGN**  
Certificate of Authorization  
ENG-TECH Consulting Limited  
No. 2475 Expiry: April 30, 2016

CLIENT:  
**BURNS MAENDEL CONSULTING ENGINEERS LTD.**

PROJECT:  
**GEOTECHNICAL INVESTIGATION - NEW ROSEDALE COLONY, MANITOBA**

DWG DESCRIPTION:  
**PROPOSED FEED MILL LOCATION PLAN**

SCALE:  
**AS SHOWN**

DRAWN BY:  
**RLG**

DATE:  
**JANUARY 2016**

FILE NO.:  
**15-398-06**

CLIENT DWG/FIG. NO.:  
**3**

**LEGEND**

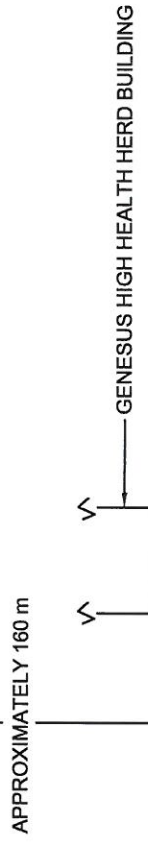

TEST HOLE LOCATION TABLE		
GPS COORDINATES OF TEST HOLES DECEMBER 1, 2015		
HOLE #	UTM	14U
TH1FM	5601266	0508539
TH2FM	5601260	0508537
TH3FM	5601262	0508536

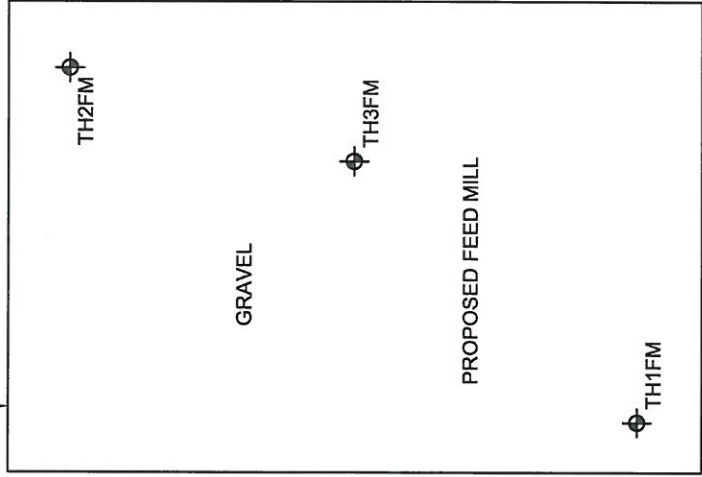

NO.	DATE	ISSUE / REVISION
0	Jan. 2016	report

 8 - 854 Marion Street  
 Winnipeg, MB R2J 0K4  
 Phone: (204) 233-1694  
 Fax: (204) 235-1579

 Certificate of Authorization  
 ENG-TECH Consulting Limited  
 No. 2475 Expiry: April 30, 2016

**CLIENT:**  
 BURNS MAENDEL CONSULTING  
 ENGINEERS LTD.

**PROJECT:**  
 GEOTECHNICAL INVESTIGATION -  
 NEW ROSEDALE COLONY,  
 MANITOBA

**DWG DESCRIPTION:**  
 PROPOSED FEED MILL  
 TEST HOLE LOCATION PLAN

**SCALE:**  
 AS SHOWN

**DRAWN BY:**  
 RLG

**DATE:**  
 JANUARY 2016

**FILE No.:**  
 15-398-06

**ENG-TECH DWG/FIG. No.:**  
 4

**LEGEND**

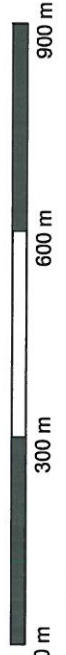
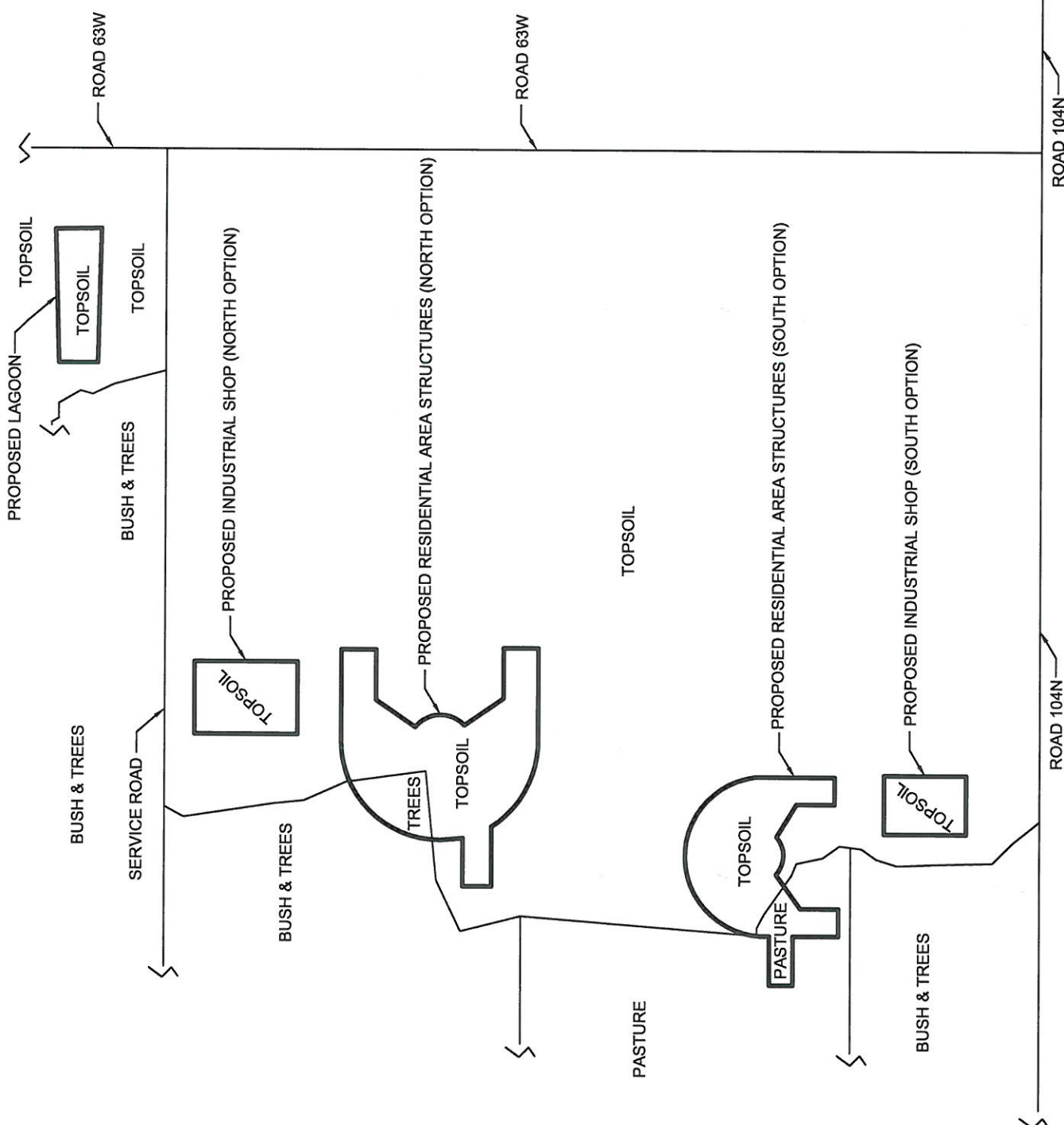

SCALE

NO.	DATE	ISSUE / REVISION
0	Jan 2016	report



6 - 854 Marion Street  
Winnipeg, MB R2J 0K4  
Phone: (204) 233-1894  
Fax: (204) 235-1579

ENG. STAMP:



CLIENT:  
**BURNS MAENDEL CONSULTING ENGINEERS LTD.**

PROJECT:  
**GEO TECHNICAL INVESTIGATION - NEW ROSEDALE COLONY, MANITOBA**

DWG DESCRIPTION:  
**PROPOSED RESIDENTIAL AREA STRUCTURES, INDUSTRIAL SHOPS & LAGOON LOCATION PLAN**

SCALE:  
**AS SHOWN**

DRAWN BY:  
**RLG**

DATE:  
**JANUARY 2016**

FILE No.:  
**15-398-06**

CLIENT DWG/FIG. No.:  
**5**

ENG-TECH DWG/FIG. No.:  
**NO.:**



**LEGEND**



TEST HOLE

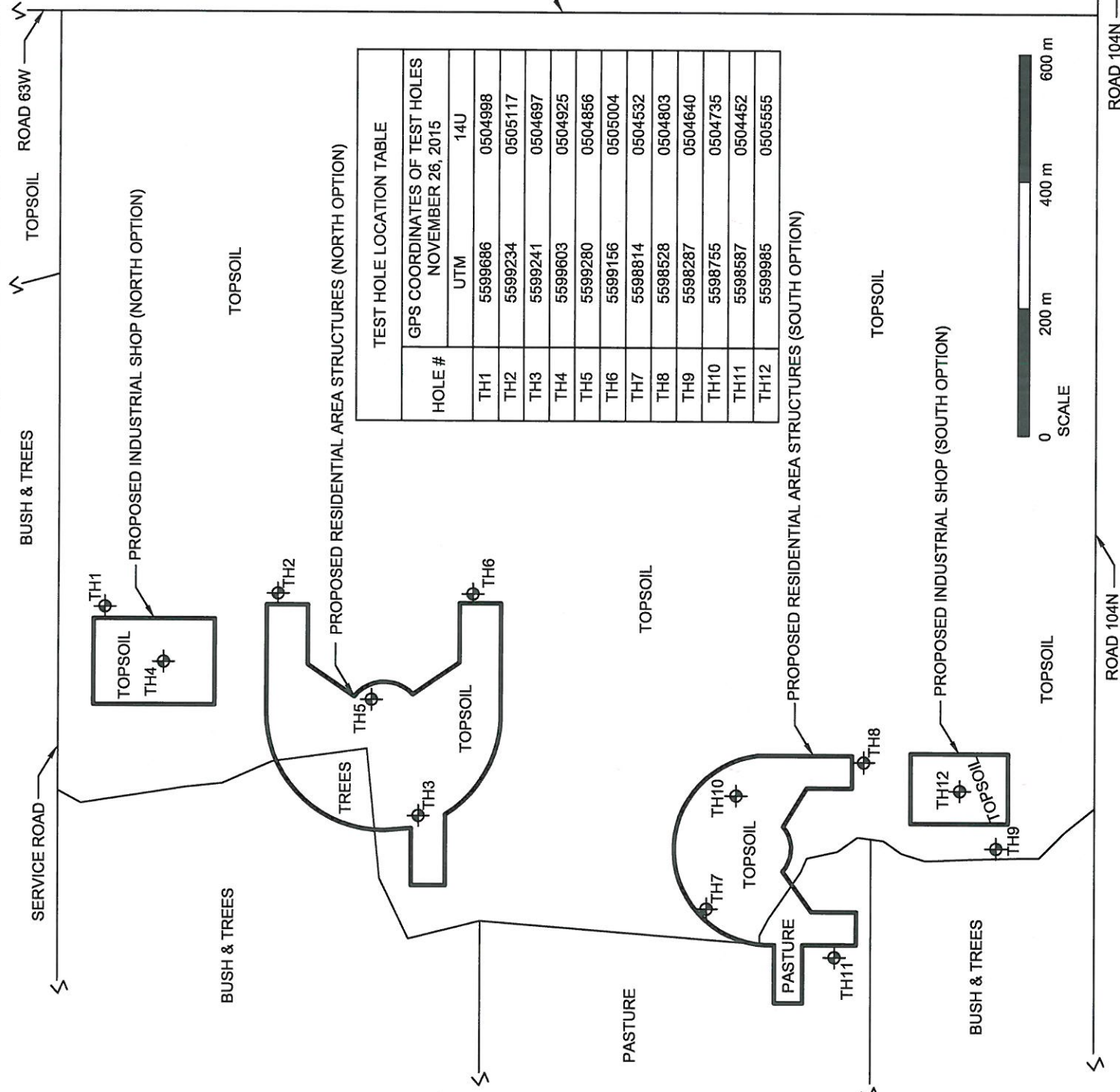

TEST HOLE LOCATION TABLE		
GPS COORDINATES OF TEST HOLES NOVEMBER 26, 2015		
HOLE #	UTM	14U
TH1	5599686	0504998
TH2	5599234	0505117
TH3	5599241	0504697
TH4	5599603	0504925
TH5	5599280	0504856
TH6	5599156	0505004
TH7	5598814	0504532
TH8	5598528	0504803
TH9	5598287	0504640
TH10	5598755	0504735
TH11	5598587	0504452
TH12	5599985	0505555

  
 6 - 854 Marion Street  
 Winnipeg, MB R2J 0K4  
 Phone: (204) 233-1694  
 Fax: (204) 235-1579



**CLIENT:** BURNS MEANDEL CONSULTING ENGINEERS LTD.  
**PROJECT:** GEOTECHNICAL INVESTIGATION - NEW ROSEDALE COLONY, MANITOBA  
**DWG DESCRIPTION:** PROPOSED RESIDENTIAL AREA STRUCTURES & INDUSTRIAL SHOPS TEST HOLE LOCATION PLAN  
**SCALE:** AS SHOWN  
**DATE:** JANUARY 2016  
**DRAWN BY:** RLG  
**FILE No.:** 15-398-06  
**CLIENT DWG/FIG. No.:**  
**ENG-TECH DWG/FIG. No.:** 6

**LEGEND**

TH13  

TEST HOLE

TEST HOLE LOCATION TABLE		
HOLE #	GPS COORDINATES OF TEST HOLES DECEMBER 16, 2015	
	UTM	14U
TH13	5599985	0505555
TH14	5599918	0505561
TH15	5599932	0505814
TH16	5599984	0505815
TH17	5599937	0505686

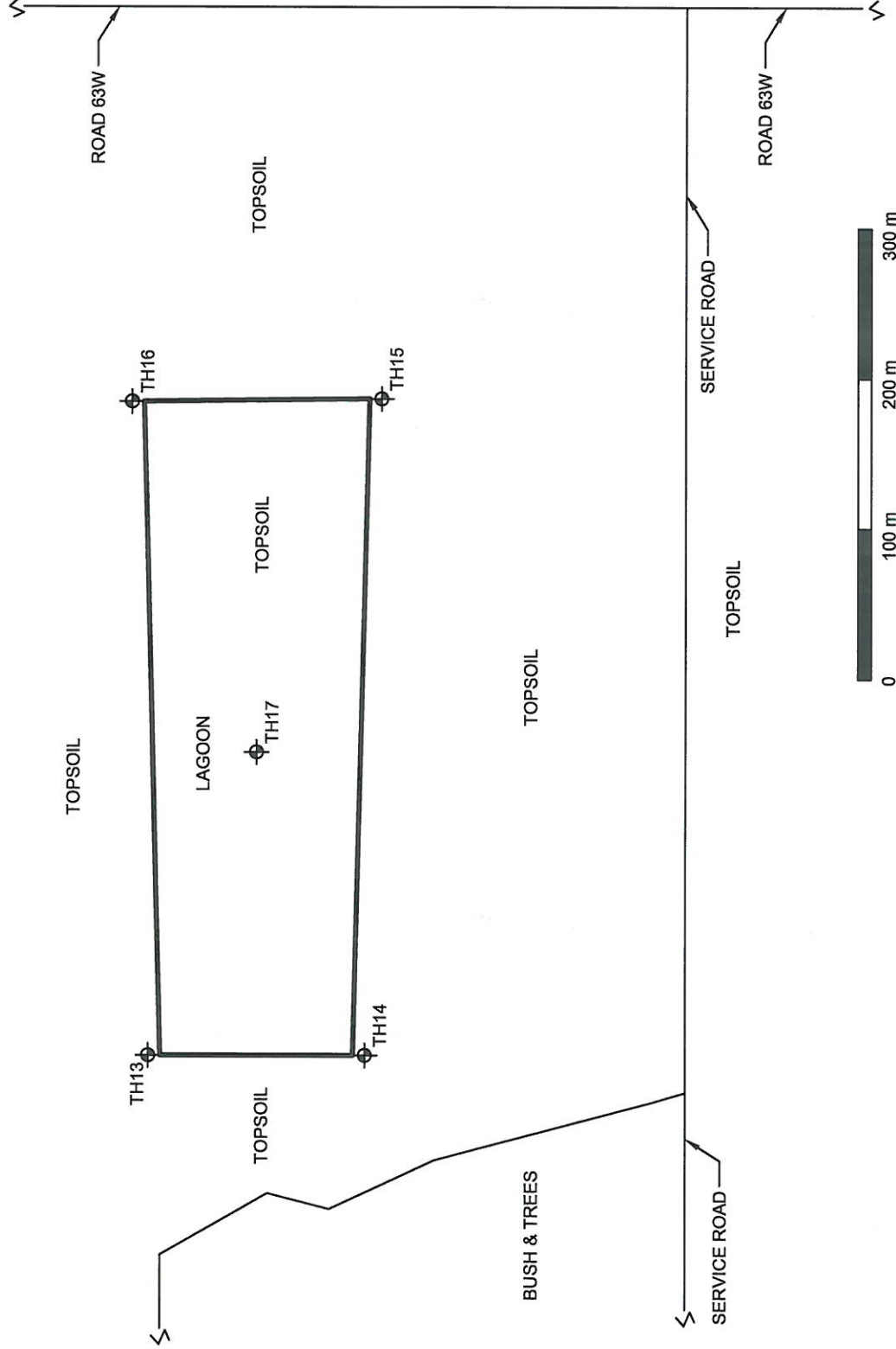

NO.	DATE	ISSUE / REVISION
0	Jan. 2016	report



6 - 854 Marion Street  
 Winnipeg, MB R2J 0K4  
 Phone: (204) 233-1694  
 Fax: (204) 235-1579



CLIENT:  
 BURNS MEANDEL CONSULTING  
 ENGINEERS LTD.

PROJECT:  
 GEOTECHNICAL INVESTIGATION -  
 NEW ROSEDALE COLONY,  
 MANITOBA

DWG DESCRIPTION:  
 PROPOSED LAGOON  
 TEST HOLE LOCATION PLAN

SCALE:  
 AS SHOWN

DRAWN BY:  
 RLG

DATE:  
 JANUARY 2016

FILE NO.:  
 15-398-06

ENG-TECH DWG/FIG. NO.:  
 7

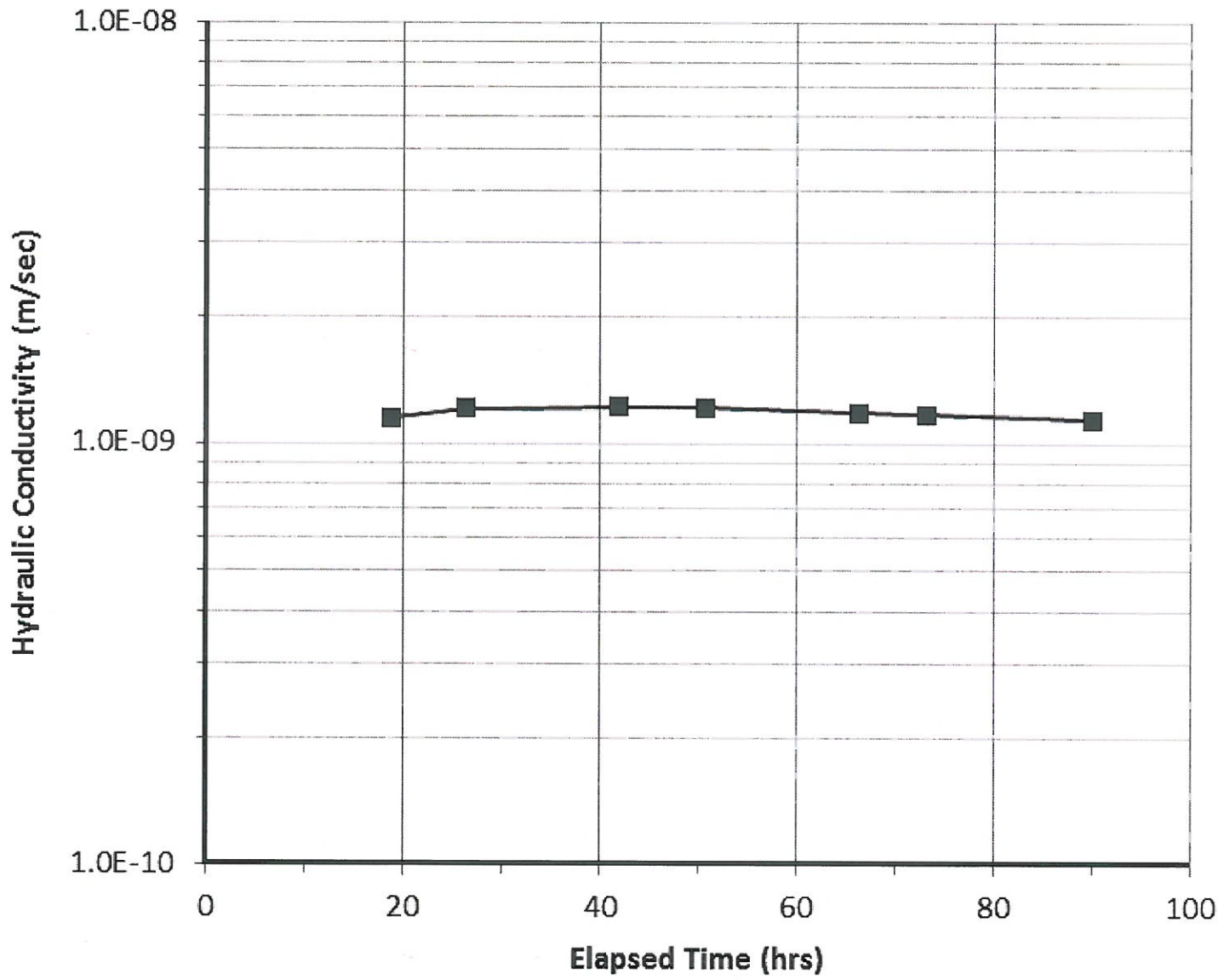

6 - 854 Marion Street  
 Winnipeg, MB R2J 0K4  
 Phone: (204) 233-1694  
 Fax: (204) 235-1579

ENG. STAMP:



Certificate of Authorization  
 ENG-TECH Consulting Limited  
 No. 2475 Expiry: April 30, 2016

CLIENT:  
 BURNS MAENDEL CONSULTING  
 ENGINEERS LTD.

DATE:  
 JANUARY 2016

DRAWN BY:  
 ERM

FIGURE No.:  
 8

REV.:

PROJECT:  
 NEW ROSEDALE COLONY, MANITOBA

FILE No.:  
 16-398-06

SCALE:  
 N/A

HYDRAULIC CONDUCTIVITY  
 VERSUS ELAPSED TIME  
 (TH15\_S5)

**TABLE 4  
HYDRAULIC CONDUCTIVITY TEST DATA  
ROSEDALE COLONY LAGOON, MANITOBA**

<b>SAMPLE IDENTIFICATION</b>	TH15_S5
<b>INITIAL VALUES</b>	
ENG-TECH Reference No.	15-398-6-26
Length of Sample in Tube (cm)	48.3
Length (cm)	6.22
Diameter (cm)	7.10
Area (cm <sup>2</sup> )	39.6
Volume (cm <sup>3</sup> )	246.4
Water Content (%)	9.2
Bulk Dry Density (kg/m <sup>3</sup> )	2145
Specific Gravity (G <sub>s</sub> ) (assumed)	2.70
Void Ratio	0.259
Degree of Saturation (%)	95.9
<b>FINAL VALUES</b>	
Length (cm)	6.19
Diameter (cm)	7.10
Area (cm <sup>2</sup> )	39.6
Volume (cm <sup>3</sup> )	245.0
Water Content (%)	10.2
Bulk Dry Density (kg/m <sup>3</sup> )	2143
Specific Gravity (G <sub>s</sub> ) (assumed)	2.70
Void Ratio	0.260
Degree of Saturation (%)	~100
<b>CONSOLIDATION PHASE</b>	
Confining Pressure (kPa)	103.4
Pore Water Pressure (kPa)	82.7
Effective Stress (kPa)	20.7
<b>PERMEATION PHASE</b>	
Confining Pressure (kPa)	103.4
Pore Water Pressure (kPa)	82.7
Effective Stress (kPa)	20.7
Hydraulic Gradient	11.4
Permeant Fluid	Distilled Water
<b>HYDRAULIC CONDUCTIVITY at TEST TEMPERATURE OF 21 °C (cm/sec)</b>	1.2 x 10 <sup>-7</sup>
<b>HYDRAULIC CONDUCTIVITY at TEMPERATURE OF 20 °C (K<sub>20</sub>) (cm/sec)</b>	1.2 x 10 <sup>-7</sup>

MODIFIED UNIFIED CLASSIFICATION SYSTEM FOR SOILS

MAJOR DIVISION		GROUP SYMBOL	GRAPH SYMBOL	TYPICAL DESCRIPTION	LABORATORY CLASSIFICATION CRITERIA	
COARSE GRAINED SOILS (MORE THAN HALF BY WEIGHT LARGER THAN 75 µm)	GRAVELS MORE THAN HALF THE COARSE FRACTION LARGER THAN 4.75 mm	CLEAN GRAVELS (TRACE OR NO FINES)	GW		WELL GRADED GRAVELS, GRAVEL-SAND MIXTURES, LITTLE OR NO FINES	$C_u = \frac{D_{60}}{D_{10}} > 4$ ; $C_c = \frac{(D_{30})^2}{D_{10} \times D_{60}} = 1 \text{ TO } 3$
			GP		POORLY GRADED GRAVELS, GRAVEL-SAND MIXTURES, LITTLE OR NO FINES	NOT MEETING ABOVE REQUIREMENTS
		DIRTY GRAVELS (WITH SOME OR MORE FINES)	GM		SILTY GRAVELS, GRAVEL-SAND-SILT MIXTURES	ATTERBERG LIMITS BELOW "A" LINE OR P.I. LESS THAN 4
			GC		CLAYEY GRAVELS, GRAVEL-SAND-CLAY MIXTURES	ATTERBERG LIMITS ABOVE "A" LINE AND P.I. MORE THAN 7
	SANDS MORE THAN HALF THE COARSE FRACTION SMALLER THAN 4.75 mm	CLEAN SANDS (TRACE OR NO FINES)	SW		WELL GRADED SANDS, GRAVELLY SANDS, LITTLE OR NO FINES	$C_u = \frac{D_{60}}{D_{10}} > 6$ ; $C_c = \frac{(D_{30})^2}{D_{10} \times D_{60}} = 1 \text{ TO } 3$
			SP		POORLY GRADED SANDS, GRAVELLY SANDS, LITTLE OR NO FINES	NOT MEETING ABOVE REQUIREMENTS
		DIRTY SANDS (WITH SOME OR MORE FINES)	SM		SILTY SANDS, SAND-SILT MIXTURES	ATTERBERG LIMITS BELOW "A" LINE OR P.I. LESS THAN 4
			SC		CLAYEY SANDS, SAND-CLAY MIXTURES	ATTERBERG LIMITS ABOVE "A" LINE AND P.I. MORE THAN 7
FINE GRAINED SOILS (MORE THAN HALF BY WEIGHT SMALLER THAN 75 µm)	SILTS BELOW "A" LINE NEGLECTIBLE ORGANIC CONTENT	LL ≤ 50%	ML		INORGANIC SILTS AND VERY FINE SANDS, ROCK FLOUR, SILTY SANDS OF SLIGHTY PLASTICITY	CLASSIFICATION IS BASED UPON PLASTICITY CHART (SEE BELOW)
		LL > 50%	MH		INORGANIC SILTS, MICACEOUS OR DIATOMACEOUS, FINE SANDY OR SILTY SOILS	
	CLAYS ABOVE "A" LINE NEGLECTIBLE ORGANIC CONTENT	LL ≤ 30%	CL		INORGANIC CLAYS OF LOW PLASTICITY, GRAVELLY, SANDY OR SILTY CLAYS, LEAN CLAYS	
		30% < LL ≤ 50%	CI		INORGANIC CLAYS OF MEDIUM PLASTICITY, SILTY CLAYS	
		LL > 50%	CH		INORGANIC CLAYS OF HIGH PLASTICITY, FAT CLAYS	
	ORGANIC SILTS & CLAYS BELOW "A" LINE	LL < 50%	OL		ORGANIC SILTS AND ORGANIC SILTY CLAYS OF LOW PLASTICITY	
		LL > 50%	OH		ORGANIC CLAYS OF HIGH PLASTICITY	
HIGHLY ORGANIC SOILS	Pt		PEAT AND OTHER HIGHLY ORGANIC SOILS	STRONG COLOUR OR ODOUR, AND OFTEN FIBROUS TEXTURE		

ADDITIONAL SYMBOLS

TILL		SANDSTONE	
FILL		GRANITE	
TOPSOIL			
CONCRETE			
SHALE			
LIMESTONE			

PLASTIC SOILS

MOISTURE	PLASTICITY	INTRUSIONS	CONSISTENCY	POCKET PEN (TSF)	(N)
DRY	LOW	ROOTLETS	VERY SOFT		< 2
DAMP	MEDIUM	OXIDES	SOFT	0 - 0.5	2 - 4
MOIST	HIGH	MICA	FIRM	0.5 - 1.0	4 - 8
WET		GYPSUM	STIFF	1.0 - 2.0	8 - 15
		ETC.	VERY STIFF	2.0 - 4.0	15 - 30
			HARD	> 4.0	> 30

$TSF \times 95.8 = kPa (q_u)$        $S_u = \frac{1}{2} \times q_u$

SOIL DESCRIPTIONS

TRACE: 0 - 10%	BOULDERS: > 200 mm	COARSE SAND: 2 - 4.75 mm
SOME: 10 - 20%	COBBLES: 75 - 200 mm	MEDIUM SAND: 0.425 - 2 mm
WITH: 20 - 35%	COURSE GRAVEL: 19 - 75 mm	FINE SAND: 0.075 - 0.425 mm
AND: 35 - 50%	FINE GRAVEL: 4.75 - 75 mm	FINES: < 0.075 mm

GRANULAR SOILS

MOISTURE	DENSITY	GRADATION	INTRUSIONS	SPT (N)
DRY	VERY LOOSE	POORLY	ROOTLETS	0 - 4
DAMP	LOOSE	WELL	OXIDES	4 - 10
MOIST	MED. DENSE		MICA	10 - 30
WET	DENSE		FINES	30 - 50
	VERY DENSE		ETC.	> 50

DEFINITIONS       $C_c$  = COMPRESSION INDEX  
 $LL$  = LIQUID LIMIT       $PL$  = PLASTIC LIMIT  
 $P.I.$  = PLASTICITY INDEX  
 $C_u$  = COEFFICIENT OF UNIFORMITY

$q_u$  = UNCONFINED COMPRESSIVE STRENGTH  
 $S_u$  = UNDRAINED SHEAR STRENGTH

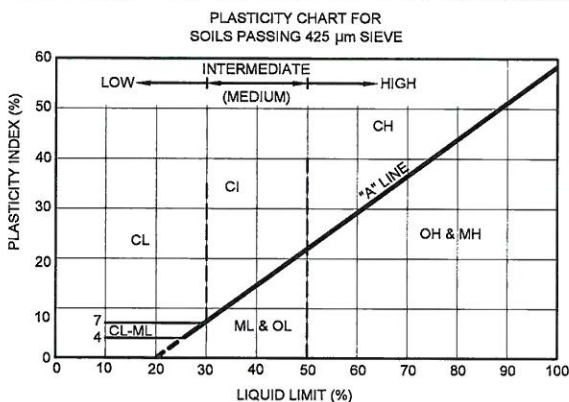

6 - 854 Marion Street  
 Winnipeg, MB R2J 0K4  
 Phone: (204) 233-1694  
 Fax: (204) 235-1579



Engineering And Testing  
Solutions That Work For You

**Test Hole #: TH1FM**

**Client:** Burns Maendel Consulting

**Site:** East of Waldersee, Manitoba

**Location:** See Figure 4

**Project:** Geotechnical Investigation - New Rosedale Colony, Manitoba

**File No.:** 15-398-06

**Date Drilled:** December 1, 2015

**Grade Elevation:** 100.0 m (local)

**Water Elevation:** - -

SUBSURFACE PROFILE				SAMPLE DATA				SHEAR STRENGTH (kPa)				
Depth (m)	Soil Symbol	Description	Elevation (m)	Sample No.	Sample Type	Moisture Content (%)	Blows/300 mm	Moisture Content (%)				
								PL	X	LL	P. Pen	Torvane
0.0		Ground Surface	100.0									
0.0 - 1.0		<b>Gravel Fill (GP) (50 mm)</b> - light brown, moist, frozen, poorly graded, fine to coarse grained, some sand.		S1	SHELBY TUBE	15.7				48		
1.0 - 2.0		<b>Glacial Till (CI)</b> - medium brown, moist, firm, medium plastic, and clay, silt, sand & gravel.		S2	SHELBY TUBE	10.9				48		
2.0 - 3.0		<b>Glacial Till (CL)</b> - tan to light brown, moist, firm, low plastic, and clay, silt, sand & gravel.		S3	SHELBY TUBE	9.7				96		
3.0 - 4.0		- below 1.8 m, stiff.		S4	SHELBY TUBE	9.1				120		
4.0 - 5.0		- below 2.7 m, very stiff.								120		
5.0 - 6.0		- below 3.4 m, tan to medium brown.		S5	SHELBY TUBE	10.2				120		
6.0 - 7.0		- below 4.9 m, soft.									23	
7.0 - 8.0				S6	SHELBY TUBE	10.7					23	
8.0 - 9.0		- below 7.9 m, firm.									20	
9.0 - 10.0				S7	SHELBY TUBE	10.4					20	
10.0 - 11.0											30	
11.0 - 12.0		- below 9.5 m, medium brown to grey, stiff.		S8	SHELBY TUBE	9.5					35	
12.0 - 13.0				S9	SHELBY TUBE	9.5					72	
13.0 - 14.0											96	
14.0 - 15.0				S10	SHELBY TUBE	10.2					72	
15.0 - 16.0												
		<b>End of Test Hole</b> - auger refusal at 12.8 m below grade on suspected dense till or boulders. - test hole dry and no sloughing during drilling. - upper 50 mm frozen. - test hole backfilled with soil auger cuttings and bentonite upon completion of drilling.										

ENG-TECH Consulting Limited

Logged by: RG

Reviewed by: *CA*

Drilled By: Subterranean (Manitoba) Limited

Drill Rig: Truck Mounted CME

Auger Size: 125 mm solid stem

Completion Depth: 12.8 m

Completion Elevation: 87.2 m

Sheet: 1 of 1

SAMPLE TYPE



SPLIT BARREL



SHELBY TUBE



AUGER CUTTINGS



SPLIT SPOON



Engineering And Testing  
Solutions That Work For You

**Test Hole #: TH2FM**

**Client:** Burns Maendel Consulting

**Site:** East of Waldersee, Manitoba

**Location:** See Figure 4

**Project:** Geotechnical Investigation - New Rosedale Colony, Manitoba

**File No.:** 15-398-06

**Date Drilled:** December 1, 2015

**Grade Elevation:** 100.0 m (local)

**Water Elevation:** - -

SUBSURFACE PROFILE				SAMPLE DATA				SHEAR STRENGTH (kPa)				
Depth (m)	Soil Symbol	Description	Elevation (m)	Sample No.	Sample Type	Moisture Content (%)	Blows/300 mm	Moisture Content (%)				
								PL	X	LL	P. Pen	Torvane
0.0		Ground Surface	100.0									
0.0 - 1.0		<b>Gravel Fill (GP)(50 mm)</b> - light brown, moist, frozen, poorly graded, fine to coarse grained, some sand.		S1	SPLIT BARREL	7.7						
1.0 - 2.0		<b>Sand (SP)</b> - light brown, moist to damp, poorly graded, fine to coarse grained, trace to some silt.		S2	SPLIT BARREL	8.6						
2.0 - 3.0		<b>Glacial Till (CL)</b> - tan to light brown, moist, very stiff, low plastic, and clay, silt, sand & gravel.		S3	SPLIT BARREL	9.2				144		
3.0 - 4.0		- below 3.4 m, tan to medium brown.		S4	SPLIT BARREL	9.3				144		
4.0 - 5.0		- below 4.1 m, firm.		S5	SHELBY TUBE	8.1				120		
5.0 - 6.0				S6	SPLIT BARREL	10.8				48		
6.0 - 7.0		- below 5.8 m, soft.		S7	SPLIT BARREL	11.1					23	
7.0 - 8.0				S8	SHELBY TUBE	11.2					23	
8.0 - 9.0		- below 7.3 m, firm.		S9	SPLIT BARREL	9.8					23	
9.0 - 10.0		- below 7.9 m, stiff.		S10	SPLIT BARREL	8.5					29	
10.0 - 11.0		- below 8.8 m, medium brown to grey, very stiff.		S11	SPLIT BARREL	10.0				72		
11.0 - 12.0				S12	SPLIT BARREL	9.7				144		
12.0 - 13.0		- below 11.9 m, stiff.		S13	SPLIT BARREL	7.3				96		
13.0 - 14.0		- below 12.5 m, very stiff.								84		
14.0 - 15.0		<b>End of Test Hole</b> - auger refusal at 12.8 m below grade on suspected dense till or boulders. - test hole dry and no sloughing during drilling.								96		
15.0 - 16.0		- upper 50 mm frozen. - test hole backfilled with soil auger cuttings and bentonite upon completion of drilling.								72		

ENG-TECH Consulting Limited

Logged by: RG

Reviewed by: CH

Drilled By: Subterranean (Manitoba) Limited

Drill Rig: Truck Mounted CME

Auger Size: 125 mm solid stem

Completion Depth: 12.8 m

Completion Elevation: 87.2 m

Sheet: 1 of 1

SAMPLE TYPE



SPLIT BARREL



SHELBY TUBE



AUGER CUTTINGS



SPLIT SPOON



**Engineering And Testing  
Solutions That Work For You**

**Test Hole #: TH3FM**

**Client:** Burns Maendel Consulting

**Site:** East of Waldersee, Manitoba

**Location:** See Figure 4

**Project:** Geotechnical Investigation - New Rosedale Colony, Manitoba

**File No.:** 15-398-06

**Date Drilled:** December 1, 2015

**Grade Elevation:** 100.0 m (local)

**Water Elevation:** - -

SUBSURFACE PROFILE			SAMPLE DATA				SHEAR STRENGTH (kPa)				
Depth (m)	Soil Symbol	Description	Elevation (m)	Sample No.	Sample Type	Moisture Content (%)	Blows/300 mm	Moisture Content (%)			
								PL	X	LL	P. Pen
0.0		<b>Ground Surface</b>	100.0								
0.0 - 1.0		<b>Gravel Fill (GP)(300 mm)</b> - light brown, moist, frozen, poorly graded, fine to coarse grained, some sand.	99.0	S1	Shelby Tube	21.1				24	
1.0 - 2.0		<b>Clay (CL)</b> - black, moist, soft, low plastic, trace to some gravel, trace organics.	98.0	S2	Shelby Tube	21.2				96	
2.0 - 3.0		<b>Clay (CL)</b> - black, moist, soft, low plastic, trace to some gravel, trace organics.	97.0	S3	Shelby Tube	19.8				96	
3.0 - 4.0		<b>Glacial Till (CI)</b> - light to medium brown, moist, stiff, medium plastic, and clay, silt, sand & gravel.	96.0	S4	Shelby Tube	8.8				144	
4.0 - 5.0		<b>Glacial Till (CI)</b> - light to medium brown, moist, stiff, medium plastic, and clay, silt, sand & gravel.	95.0	S5	Shelby Tube	9.3				144	
5.0 - 6.0		<b>Glacial Till (CL)</b> - tan to medium brown, moist, very stiff, low plastic, and clay, silt, sand & gravel.	94.0	S6	Shelby Tube	10.9				108	
6.0 - 7.0		- below 4.9 m, soft.	93.0							20	
7.0 - 8.0		- below 7.9 m, stiff.	92.0	S7	Shelby Tube	11.8				20	
8.0 - 9.0		- below 8.8 m, very stiff.	91.0	S8	Shelby Tube	12.7				10	
9.0 - 10.0		- below 9.5 m, medium brown to grey.	90.0	S9	Shelby Tube	8.9				96	
10.0 - 11.0		- below 10.2 m, stiff.	89.0	S10	Shelby Tube	9.1				144	
11.0 - 12.0		<b>End of Test Hole</b> - end of test hole at 10.7 m below grade. - test hole dry and no sloughing during drilling.	88.0							120	
12.0 - 13.0		- upper 300 mm frozen. - test hole backfilled with soil auger cuttings and bentonite upon completion of drilling.	87.0							96	
13.0 - 14.0			86.0								
14.0 - 15.0			85.0								
15.0 - 16.0			84.0								

ENG- TECH Consulting Limited

Logged by: RG

Reviewed by: *CA*

Drilled By: Subterranean (Manitoba) Limited

Drill Rig: Truck Mounted CME

Auger Size: 125 mm solid stem

Completion Depth: 10.7 m

Completion Elevation: 89.3 m

Sheet: 1 of 1

SAMPLE TYPE



SPLIT BARREL



SHELBY TUBE



AUGER CUTTINGS



SPLIT SPOON





**Engineering And Testing  
Solutions That Work For You**

**Test Hole #: TH1**  
**Client:** Burns Maendel Consulting  
**Site:** East of Waldersee, Manitoba  
**Location:** See Figure 6  
**Project:** Geotechnical Investigation - New Rosedale Colony, Manitoba

**File No.:** 15-398-06  
**Date Drilled:** December 16, 2015  
**Grade Elevation:** 271.9 m  
**Water Elevation:** - -

SUBSURFACE PROFILE				SAMPLE DATA				SHEAR STRENGTH (kPa)						
Depth (m)	Soil Symbol	Description	Elevation (m)	Sample No.	Sample Type	Moisture Content (%)	Blows/300 mm	Moisture Content (%)						
								PL	X	LL	UC			
								20	40	60	80	P. Pen	Torvane	UC
0.0		<b>Ground Surface</b> <b>Topsoil (100 mm)</b> - dark brown, moist, frozen, organics. <b>Glacial Till (CL)</b> - light to medium brown, moist, very stiff, low plastic, and clay, silt, sand & gravel.	271.9											
1.0			271.0	S1		8.8						120		
2.0		- below 1.8 m, stiff.	270.0	S2		7.6						168		
3.0		- below 2.7 m, very stiff.	269.0	S3		12.6						84		
4.0			268.0	S4		9.4						168		
5.0			267.0	S5		8.1						144		
6.0		<b>End of Test Hole</b> - auger refusal at 4.2 m below grade on hard till. - end of test hole at 4.7 m below grade. - test hole dry and no sloughing during drilling. - upper 100 mm frozen. - test hole backfilled with soil auger cuttings and bentonite upon completion of drilling. - elevations based on survey information provided by client.	266.0	S6		7.0	72							

ENG- TECH Consulting Limited

Logged by: RG

Reviewed by:

Drilled By: Paddock Drilling Limited

Drill Rig: Truck Mounted CT250

Auger Size: 125 mm solid stem

Completion Depth: 4.7 m

Completion Elevation: 267.2 m

Sheet: 1 of 1

SAMPLE TYPE



SPLIT BARREL



SHELBY TUBE



AUGER CUTTINGS



SPLIT SPOON



Engineering And Testing  
Solutions That Work For You

**Test Hole #: TH2**  
**Client:** Burns Maendel Consulting  
**Site:** East of Walderssee, Manitoba  
**Location:** See Figure 6  
**Project:** Geotechnical Investigation - New Rosedale Colony, Manitoba

**File No.:** 15-398-06  
**Date Drilled:** December 16, 2015  
**Grade Elevation:** 272.2 m  
**Water Elevation:** - -

SUBSURFACE PROFILE				SAMPLE DATA				SHEAR STRENGTH (kPa)					
Depth (m)	Soil Symbol	Description	Elevation (m)	Sample No.	Sample Type	Moisture Content (%)	Blows/300 mm	Moisture Content (%)					
								PL	X	LL	P. Pen	Torvane	UC
0.0		Ground Surface <b>Topsoil (150 mm)</b> - dark brown, moist, frozen, organics.	272.2										
		<b>Glacial Till (CL)</b> - light to medium brown, moist, stiff, low plastic, and clay, silt, sand & gravel.											
1.0		- below 1.2 m, very stiff.	271.0	S1		9.9					96		
				S2		7.8					120		
2.0			270.0	S3		6.8					144		
3.0			269.0	S4		7.2					168		
		- below 3.4 m, hard.		S5		7.9	84						
4.0		<b>End of Test Hole</b> - auger refusal at 3.4 m below grade on hard till. - end of test hole at 3.8 m below grade. - test hole dry and no sloughing during drilling. - upper 150 mm frozen. - test hole backfilled with soil auger cuttings and bentonite upon completion of drilling. - elevations based on survey information provided by client.	268.0										
5.0			267.0										
6.0													

ENG- TECH Consulting Limited

Logged by: RG

Reviewed by:

Drilled By: Paddock Drilling Limited

Drill Rig: Truck Mounted CT250

Auger Size: 125 mm solid stem

Completion Depth: 3.8 m

Completion Elevation: 268.4 m

Sheet: 1 of 1

SAMPLE TYPE



SPLIT BARREL



SHELBY TUBE



AUGER CUTTINGS



SPLIT SPOON



Engineering And Testing  
Solutions That Work For You

**Test Hole #: TH3**  
**Client:** Burns Maendel Consulting  
**Site:** East of Waldersee, Manitoba  
**Location:** See Figure 6  
**Project:** Geotechnical Investigation - New Rosedale Colony, Manitoba

**File No.:** 15-398-06  
**Date Drilled:** December 16, 2015  
**Grade Elevation:** 273.6 m  
**Water Elevation:** - -

SUBSURFACE PROFILE				SAMPLE DATA				SHEAR STRENGTH (kPa)							
Depth (m)	Soil Symbol	Description	Elevation (m)	Sample No.	Sample Type	Moisture Content (%)	Blows/300 mm	Moisture Content (%)				P. Pen	Torvane	UC	
								PL	X	LL					
0.0		<b>Ground Surface</b> <b>Topsoil (150 mm)</b> - dark brown, moist, frozen, organics.	273.6												
		<b>Glacial Till (CL)</b> - light to medium brown, moist, stiff, low plastic, and clay, silt, sand & gravel.	273.0												
1.0		- below 1.2 m, very stiff.		S1		10.8						96			
			272.0	S2		10.4						144			
2.0			271.0	S3		10.5						144			
3.0			270.0	S4		12.6						144			
4.0		- below 3.5 m, stiff.		S5		11.2						96			
		<b>End of Test Hole</b> - auger refusal at 4.3 m below grade on suspected dense till or boulders. - test hole dry and no sloughing during drilling. - upper 150 mm frozen. - test hole backfilled with soil auger cuttings and bentonite upon completion of drilling. - elevations based on survey information provided by client.	269.0												
5.0			268.0												
6.0															

ENG- TECH Consulting Limited

Logged by: RG

Reviewed by: CA

Drilled By: Paddock Drilling Limited

Drill Rig: Truck Mounted CT250

Auger Size: 125 mm solid stem

Completion Depth: 4.3 m

Completion Elevation: 269.3 m

Sheet: 1 of 1

SAMPLE TYPE



SPLIT BARREL



SHELBY TUBE



AUGER CUTTINGS



SPLIT SPOON



**Engineering And Testing  
Solutions That Work For You**

**Test Hole #: TH4**  
**Client:** Burns Maendel Consulting  
**Site:** East of Waldersee, Manitoba  
**Location:** See Figure 6  
**Project:** Geotechnical Investigation - New Rosedale Colony, Manitoba

**File No.:** 15-398-06  
**Date Drilled:** December 16, 2015  
**Grade Elevation:** 272.7 m  
**Water Elevation:** - -

SUBSURFACE PROFILE			SAMPLE DATA				SHEAR STRENGTH (kPa)					
Depth (m)	Soil Symbol	Description	Elevation (m)	Sample No.	Sample Type	Moisture Content (%)	Blows/300 mm	Moisture Content (%)				
								PL	X	LL	P. Pen	Torvane
0.0		<b>Ground Surface</b> <b>Topsoil (100 mm)</b> - dark brown, moist, frozen, organics. <b>Glacial Till (CL)</b> - light to medium brown, moist, stiff, low plastic, and clay, silt, sand & gravel. - below 1.2 m, very stiff. - below 2.7 m, hard.	272.7									
1.0			272.0	S1		7.0				96		
2.0			271.0	S2		7.4				120		
3.0			270.0	S3		6.4				144		
			270.0	S4		6.2				168		
			270.0	S5		6.5	>100					
4.0		<b>End of Test Hole</b> - auger refusal at 2.7 m below grade on hard till. - SPT refusal at 3.2 m below grade on suspected hard till or boulders. - test hole dry and no sloughing during drilling. - upper 100 mm frozen. - test hole backfilled with soil auger cuttings and bentonite upon completion of drilling. - elevations based on survey information provided by client.	269.0									
5.0			268.0									
6.0			267.0									

ENG- TECH Consulting Limited

Logged by: RG

Reviewed by:

Drilled By: Paddock Drilling Limited

Drill Rig: Truck Mounted CT250

Auger Size: 125 mm solid stem

Completion Depth: 3.2 m

Completion Elevation: 269.5 m

Sheet: 1 of 1

SAMPLE TYPE



SPLIT BARREL



SHELBY TUBE



AUGER CUTTINGS



SPLIT SPOON



Engineering And Testing  
Solutions That Work For You

**Test Hole #: TH5**  
**Client:** Burns Maendel Consulting  
**Site:** East of Waldersee, Manitoba  
**Location:** See Figure 6  
**Project:** Geotechnical Investigation - New Rosedale Colony, Manitoba

**File No.:** 15-398-06  
**Date Drilled:** December 16, 2015  
**Grade Elevation:** 272.8 m  
**Water Elevation:** - -

SUBSURFACE PROFILE				SAMPLE DATA				SHEAR STRENGTH (kPa)						
Depth (m)	Soil Symbol	Description	Elevation (m)	Sample No.	Sample Type	Moisture Content (%)	Blows/300 mm	Moisture Content (%)				P. Pen	Torvane	UC
								PL	X	LL				
0.0		<b>Ground Surface</b> <b>Topsoil (100 mm)</b> - dark brown, moist, frozen, organics. <b>Glacial Till (CL)</b> - light to medium brown, moist, soft, low plastic, and clay, silt, sand & gravel.	272.8											
1.0		- below 1.2 m, stiff.	272.0	S1		17.4						24		
2.0		- below 2.1 m, very stiff.	271.0	S2		10.9						72		
3.0		- below 2.6 m, hard.	270.0	S3		9.5						120		
3.0		<b>End of Test Hole</b> - auger refusal at 2.6 m below grade on hard till. - end of test hole at 3.0 m below grade. - test hole dry and no sloughing during drilling. - upper 100 mm frozen. - test hole backfilled with soil auger cuttings and bentonite upon completion of drilling. - elevations based on survey information provided by client.	270.0	S4		7.1	59							
4.0			269.0											
5.0			268.0											
6.0			267.0											

ENG- TECH Consulting Limited

Logged by: RG

Reviewed by: CA

Drilled By: Paddock Drilling Limited

Drill Rig: Truck Mounted CT250

Auger Size: 125 mm solid stem

Completion Depth: 3.0 m

Completion Elevation: 269.8 m

Sheet: 1 of 1

SAMPLE TYPE



SPLIT BARREL



SHELBY TUBE



AUGER CUTTINGS



SPLIT SPOON



**Engineering And Testing  
Solutions That Work For You**

**Test Hole #: TH6**  
**Client:** Burns Maendel Consulting  
**Site:** East of Walderssee, Manitoba  
**Location:** See Figure 6  
**Project:** Geotechnical Investigation - New Rosedale Colony, Manitoba

**File No.:** 15-398-06  
**Date Drilled:** December 16, 2015  
**Grade Elevation:** 272.4 m  
**Water Elevation:** - -

SUBSURFACE PROFILE				SAMPLE DATA				SHEAR STRENGTH (kPa)				
Depth (m)	Soil Symbol	Description	Elevation (m)	Sample No.	Sample Type	Moisture Content (%)	Blows/300 mm	Moisture Content (%)				
								PL	X	LL	P. Pen	Torvane
0.0		Ground Surface	272.4									
		<b>Topsoil (100 mm)</b> - dark brown, moist, frozen, organics.										
		<b>Glacial Till (CL)</b> - light to medium brown, moist, very stiff, low plastic, and clay, silt, sand & gravel.	272.0									
1.0			271.0	S1		11.8					144	
			271.0	S2		11.9					144	
2.0		- below 2.0 m, stiff.	270.0	S3		7.7					96	
			269.0	S4		7.8					72	
4.0			268.0	S5		7.9					96	
		<b>End of Test Hole</b> - auger refusal at 4.0 m below grade on suspected dense till or boulders. - test hole dry and no sloughing during drilling. - upper 100 mm frozen. - test hole backfilled with soil auger cuttings and bentonite upon completion of drilling. - elevations based on survey information provided by client.	267.0									

ENG- TECH Consulting Limited

Logged by: RG

Reviewed by:

Drilled By: Paddock Drilling Limited

Drill Rig: Truck Mounted BT250

Auger Size: 125 mm solid stem

Completion Depth: 4.0 m

Completion Elevation: 268.4 m

Sheet: 1 of 1

SAMPLE TYPE



SPLIT BARREL



SHELBY TUBE



AUGER CUTTINGS



SPLIT SPOON



Engineering And Testing  
Solutions That Work For You

**Test Hole #: TH7**  
**Client:** Burns Maendel Consulting  
**Site:** East of Waldersee, Manitoba  
**Location:** See Figure 6  
**Project:** Geotechnical Investigation - New Rosedale Colony, Manitoba

**File No.:** 15-398-06  
**Date Drilled:** December 16, 2015  
**Grade Elevation:** 274.6 m  
**Water Elevation:** - -

SUBSURFACE PROFILE				SAMPLE DATA				SHEAR STRENGTH (kPa)					
Depth (m)	Soil Symbol	Description	Elevation (m)	Sample No.	Sample Type	Moisture Content (%)	Blows/300 mm	Moisture Content (%)			P. Pen	Torvane	UC
								PL	X	LL			
0.0		<b>Ground Surface</b> <b>Topsoil (50 mm)</b> - dark brown, moist, frozen, organics. <b>Glacial Till (CL)</b> - light to medium brown, moist, very stiff, low plastic, and clay, silt, sand & gravel.	274.6										
1.0			274.0	S1		12.6					144		
2.0			273.0	S2		9.9					144		
3.0			272.0	S3		7.9					168		
3.2		- below 2.7 m, hard.		S6		8.3	51						
4.0		<b>End of Test Hole</b> - auger refusal at 2.7 m below grade on hard till. - end of test hole at 3.2 m below grade. - test hole dry and no sloughing during drilling. - upper 50 mm frozen. - test hole backfilled with soil auger cuttings and bentonite upon completion of drilling. - elevations based on survey information provided by client.	271.0										
5.0			270.0										
6.0			269.0										

ENG- TECH Consulting Limited

Logged by: RG

Reviewed by:

Drilled By: Paddock Drilling Limited

Drill Rig: Truck Mounted CT250

Auger Size: 125 mm solid stem

Completion Depth: 3.2 m

Completion Elevation: 271.4 m

Sheet: 1 of 1

SAMPLE TYPE



SPLIT BARREL



SHELBY TUBE



AUGER CUTTINGS



SPLIT SPOON



Engineering And Testing  
Solutions That Work For You

**Test Hole #: TH8**  
**Client:** Burns Maendel Consulting  
**Site:** East of Waldersee, Manitoba  
**Location:** See Figure 6  
**Project:** Geotechnical Investigation - New Rosedale Colony, Manitoba

**File No.:** 15-398-06  
**Date Drilled:** December 16, 2015  
**Grade Elevation:** 272.5 m  
**Water Elevation:** - -

SUBSURFACE PROFILE				SAMPLE DATA				SHEAR STRENGTH (kPa)				
Depth (m)	Soil Symbol	Description	Elevation (m)	Sample No.	Sample Type	Moisture Content (%)	Blows/300 mm	Moisture Content (%)				
								PL	X	LL	P. Pen	Torvane
0.0		Ground Surface	272.5									
		<b>Topsoil (150 mm)</b> - dark brown, moist, frozen, organics.										
		<b>Glacial Till (CL)</b> - light to medium brown, moist, very stiff, low plastic, and clay, silt, sand & gravel.										
1.0				S1		11.9					144	
			271.0	S2		9.4					144	
			270.0	S3		7.4					144	
				S4		7.1					144	
			269.0	S5		7.0					144	
				S6		6.7	63					
4.0		- below 4.0 m, hard.										
		<b>End of Test Hole</b> - auger refusal at 4.0 m below grade on hard till. - end of test hole at 4.4 m below grade. - test hole dry and no sloughing during drilling. - upper 150 mm frozen. - test hole backfilled with soil auger cuttings and bentonite upon completion of drilling. - elevations based on survey information provided by client.	268.0									
5.0												
			267.0									
6.0												

ENG-TECH Consulting Limited

Logged by: RG

Reviewed by:

Drilled By: Paddock Drilling Limited

Drill Rig: Truck Mounted CT250

Auger Size: 125 mm solid stem

Completion Depth: 4.4 m

Completion Elevation: 268.1 m

Sheet: 1 of 1

SAMPLE TYPE



SPLIT BARREL



SHELBY TUBE



AUGER CUTTINGS



SPLIT SPOON





Engineering And Testing  
Solutions That Work For You

**Test Hole #: TH9**  
**Client:** Burns Maendel Consulting  
**Site:** East of Waldersee, Manitoba  
**Location:** See Figure 6  
**Project:** Geotechnical Investigation - New Rosedale Colony, Manitoba

**File No.:** 15-398-06  
**Date Drilled:** December 16, 2015  
**Grade Elevation:** 272.1 m  
**Water Elevation:** - -

SUBSURFACE PROFILE				SAMPLE DATA				SHEAR STRENGTH (kPa)					
Depth (m)	Soil Symbol	Description	Elevation (m)	Sample No.	Sample Type	Moisture Content (%)	Blows/300 mm	Moisture Content (%)			P. Pen	Torvane	UC
								PL	X	LL			
0.0		Ground Surface	272.1										
0.0 - 0.1		<b>Topsoil (100 mm)</b> - dark brown, moist, frozen, organics.											
0.1 - 1.0		<b>Glacial Till (CL)</b> - light to medium brown, moist, very stiff, low plastic, and clay, silt, sand & gravel.											
1.0			271.0	S1	SPLIT BARREL	9.2					120		
1.5				S2	SPLIT BARREL	9.3					120		
2.0		- below 1.8 m, stiff.	270.0	S3	SPLIT BARREL	7.8					96		
3.0			269.0	S4	SPLIT BARREL	8.8					72		
4.0		- below 4.3 m, medium brown to grey.	268.0								96		
5.0			267.0	S5	SPLIT BARREL	7.8					96		
5.5		- below 5.5 m, hard.		S6	SPLIT SPOON	7.8	35						
6.0		<b>End of Test Hole</b> - auger refusal at 5.5 m below grade on hard till. - end of test hole at 5.9 m below grade. - test hole dry and no sloughing during drilling.	266.0										
7.0		- upper 100 mm frozen. - test hole backfilled with soil auger cuttings and bentonite upon completion of drilling. - elevations based on survey information provided by client.	265.0										
8.0													

ENG- TECH Consulting Limited

Logged by: RG

Reviewed by: CA

Drilled By: Paddock Drilling Limited

Drill Rig: Truck Mounted CT250

Auger Size: 125 mm solid stem

Completion Depth: 5.9 m

Completion Elevation: 266.2 m

Sheet: 1 of 1

SAMPLE TYPE



SPLIT BARREL



SHELBY TUBE



AUGER CUTTINGS



SPLIT SPOON



Engineering And Testing  
Solutions That Work For You

**Test Hole #: TH10**

**Client:** Burns Maendel Consulting

**Site:** East of Waldersee, Manitoba

**Location:** See Figure 6

**Project:** Geotechnical Investigation - New Rosedale Colony, Manitoba

**File No.:** 15-398-06

**Date Drilled:** December 16, 2015

**Grade Elevation:** 274.0 m

**Water Elevation:** - -

SUBSURFACE PROFILE				SAMPLE DATA				SHEAR STRENGTH (kPa)						
Depth (m)	Soil Symbol	Description	Elevation (m)	Sample No.	Sample Type	Moisture Content (%)	Blows/300 mm	Moisture Content (%)						
								PL	X	LL	UC			
								20	40	60	80	P. Pen	Torvane	UC
0.0		<b>Ground Surface</b> <b>Topsoil (75 mm)</b> - dark brown, moist, frozen, organics. <b>Glacial Till (CL)</b> - light to medium brown, moist, very stiff, low plastic, and clay, silt, sand & gravel. - below 1.2 m, very stiff.	274.0											
1.0			273.0	S1		6.7						96		
			272.0	S2		6.7						120		
2.0			272.0	S3		6.6						144		
3.0			271.0	S4		6.4						168		
			271.0	S5		6.5	>100							
4.0		<b>End of Test Hole</b> - auger refusal at 3.0 m below grade on hard till. - SPT refusal at 3.5 m below grade on suspected hard till or boulder. - test hole dry and no sloughing during drilling. - upper 75 mm frozen. - test hole backfilled with soil auger cuttings and bentonite upon completion of drilling. - elevations based on survey information provided by client.	270.0											
5.0			269.0											
6.0			268.0											

ENG- TECH Consulting Limited

Logged by: RG

Reviewed by:

Drilled By: Paddock Drilling Limited

Drill Rig: Truck Mounted CT250

Auger Size: 125 mm solid stem

Completion Depth: 3.5 m

Completion Elevation: 270.5 m

Sheet: 1 of 1

SAMPLE TYPE



SPLIT BARREL



SHELBY TUBE



AUGER CUTTINGS



SPLIT SPOON



Engineering And Testing  
Solutions That Work For You

**Test Hole #: TH11**

**Client:** Burns Maendel Consulting

**Site:** East of Waldersee, Manitoba

**Location:** See Figure 6

**Project:** Geotechnical Investigation - New Rosedale Colony, Manitoba

**File No.:** 15-398-06

**Date Drilled:** December 16, 2015

**Grade Elevation:** 274.6 m

**Water Elevation:** - -

SUBSURFACE PROFILE				SAMPLE DATA				SHEAR STRENGTH (kPa)				
Depth (m)	Soil Symbol	Description	Elevation (m)	Sample No.	Sample Type	Moisture Content (%)	Blows/300 mm	Moisture Content (%)				
								PL	X	LL	P. Pen	Torvane
0.0		Ground Surface	274.6									
		<b>Topsoil (50 mm)</b> - dark brown, moist, frozen, organics.										
		<b>Glacial Till (CL)</b> - light to medium brown, moist, very stiff, low plastic, and clay, silt, sand & gravel.	274.0									
1.0				S1		8.5					72	
			273.0	S2		7.1					120	
2.0				S3		6.6					144	
		- below 2.4 m, hard.	272.0	S6		6.9	>100					
3.0		<b>End of Test Hole</b> - auger refusal at 2.4 m below grade on hard till. - SPT refusal at 2.9 m below grade on suspected hard till or boulder. - test hole dry and no sloughing during drilling. - upper 50 mm frozen. - test hole backfilled with soil auger cuttings and bentonite upon completion of drilling. - elevations based on survey information provided by client.	271.0									
4.0			270.0									
5.0			269.0									
6.0												

ENG-TECH Consulting Limited

Logged by: RG

Reviewed by:

Drilled By: Paddock Drilling Limited

Drill Rig: Truck Mounted CT250

Auger Size: 125 mm solid stem

Completion Depth: 2.9 m

Completion Elevation: 271.7 m

Sheet: 1 of 1

SAMPLE TYPE



SPLIT BARREL



SHELBY TUBE



AUGER CUTTINGS



SPLIT SPOON



Engineering And Testing  
Solutions That Work For You

**Test Hole #: TH12**

**Client:** Burns Maendel Consulting

**Site:** East of Walderssee, Manitoba

**Location:** See Figure 6

**Project:** Geotechnical Investigation - New Rosedale Colony, Manitoba

**File No.:** 15-398-06

**Date Drilled:** December 2, 2015

**Grade Elevation:** 272.4 m

**Water Elevation:** - -

SUBSURFACE PROFILE				SAMPLE DATA				SHEAR STRENGTH (kPa)				
Depth (m)	Soil Symbol	Description	Elevation (m)	Sample No.	Sample Type	Moisture Content (%)	Blows/300 mm	Moisture Content (%)				
								PL	X	LL	P. Pen	Torvane
0.0		Ground Surface	272.4									
		<b>Topsoil (100 mm)</b> - dark brown, moist, frozen, organics.										
1.0		<b>Glacial Till (CL)</b> - tan to light brown, moist, stiff, low plastic, and clay, silt, sand & gravel.		S1	SPLIT BARREL	10.4				96		
2.0		- below 1.8 m, tan to medium brown, very stiff.	271.0	S2	SPLIT BARREL	9.7				84		
3.0		- below 2.7 m, stiff.	270.0	S3	SPLIT BARREL	9.2				108		
4.0		- below 3.4 m, stiff.	269.0	S4	SPLIT BARREL	9.0				96		
5.0		- below 3.4 m, stiff.	268.0	S5	SHELBY TUBE	9.3				96		
6.0		- below 4.1 m, medium brown to grey, very stiff.	267.0	S6	SPLIT BARREL	9.0				60		
7.0		- below 6.6 m, stiff.	266.0	S7	SPLIT BARREL	8.7				144		
8.0		- below 6.6 m, stiff.	265.0	S8	SHELBY TUBE	8.1				144		130
9.0		- below 6.6 m, stiff.	264.0	S9	SPLIT BARREL	9.3				96		
10.0		<b>End of Test Hole</b> - auger refusal at 7.6 m below grade on suspected dense till or boulders. - test hole dry and no sloughing during drilling. - upper 100 mm frozen. - test hole backfilled with soil auger cuttings and bentonite upon completion of drilling. - elevations based on survey information provided by client.	263.0									
11.0			262.0									
12.0			261.0									

ENG-TECH Consulting Limited

Logged by: RG

Reviewed by: *CA*

Drilled By: Subterranean (Manitoba) Limited

Drill Rig: Truck Mounted CME

Auger Size: 125 mm solid stem

Completion Depth: 7.6 m

Completion Elevation: 264.8 m

Sheet: 1 of 1

SAMPLE TYPE



SPLIT BARREL



SHELBY TUBE



AUGER CUTTINGS



SPLIT SPOON



Engineering And Testing  
Solutions That Work For You

**Test Hole #: TH13**

**Client:** Burns Maendel Consulting

**Site:** East of Waldersee, Manitoba

**Location:** See Figure 7

**Project:** Geotechnical Investigation - New Rosedale Colony, Manitoba

**File No.:** 15-398-06

**Date Drilled:** December 16, 2015

**Grade Elevation:** 270.0 m

**Water Elevation:** - -

SUBSURFACE PROFILE				SAMPLE DATA				SHEAR STRENGTH (kPa)							
Depth (m)	Soil Symbol	Description	Elevation (m)	Sample No.	Sample Type	Moisture Content (%)	Blows/300 mm	Moisture Content (%)				P. Pen	Torvane	UC	
								PL	X	LL					
0.0		<b>Ground Surface</b>	270.0												
		<b>Topsoil (100 mm)</b> - dark brown, moist, frozen, organics.													
1.0		<b>Glacial Till (CL)</b> - light to medium brown, moist, stiff, low plastic, and clay, silt, sand & gravel. - below 1.2 m, very stiff.	269.0	S1	S	11.3						96			
2.0			268.0	S2	S	11.9						144			
3.0			267.0	S3	S	9.5						144			
4.0			266.0	S4	S	8.2						120			
5.0		<b>Glacial Till (CL-ML)</b> - medium brown to grey, moist, stiff, low plastic, and clay, silt, sand & gravel. - below 3.7 m, medium to dark brown, stiff.	265.0	S5	S	9.6						96			
6.0			264.0	S6	S	8.7						96			
7.0			263.0									120			
8.0			262.0	S7	S	10.6						48			
9.0			261.0	S8	S	10.1						36			
10.0		<b>End of Test Hole</b> - end of test hole at 9.1 m below grade. - test hole dry and no sloughing during drilling. - upper 100 mm frozen. - test hole backfilled with soil auger cuttings and bentonite upon completion of drilling. - elevations based on survey information provided by client.	260.0									48			
11.0			259.0									72			
12.0			258.0												

ENG-TECH Consulting Limited

Logged by: RG

Reviewed by: CA

Drilled By: Paddock Drilling Limited

Drill Rig: Truck Mounted CT250

Auger Size: 125 mm solid stem

Completion Depth: 9.1 m

Completion Elevation: 260.9 m

Sheet: 1 of 1

SAMPLE TYPE



SPLIT BARREL



SHELBY TUBE



AUGER CUTTINGS



SPLIT SPOON



Engineering And Testing  
Solutions That Work For You

**Test Hole #: TH14**

**Client:** Burns Maendel Consulting

**Site:** East of Waldersee, Manitoba

**Location:** See Figure 7

**Project:** Geotechnical Investigation - New Rosedale Colony, Manitoba

**File No.:** 15-398-06

**Date Drilled:** December 16, 2015

**Grade Elevation:** 270.0 m

**Water Elevation:** - -

SUBSURFACE PROFILE				SAMPLE DATA				SHEAR STRENGTH (kPa)			
Depth (m)	Soil Symbol	Description	Elevation (m)	Sample No.	Sample Type	Moisture Content (%)	Blows/300 mm	Moisture Content (%)			
								PL	X	LL	P. Pen
0.0		<b>Ground Surface</b> <b>Topsoil (100 mm)</b> - dark brown, moist, frozen, organics. <b>Glacial Till (CL)</b> - light to medium brown, moist, very stiff, low plastic, and clay, silt, sand & gravel.	270.0								
1.0		- below 1.2 m, stiff.	269.0	S1		12.2				72	
2.0		- below 1.8 m, very stiff.	268.0	S2		8.5				96	
3.0		- below 3.0 m, hard.	267.0	S3		7.7				120	
				S4		9.6				48	
				S5		8.4				48	
				S6		9.6	40				
4.0		<b>End of Test Hole</b> - auger refusal at 3.0 m below grade on hard till. - end of test hole at 3.5 m below grade. - test hole dry and no sloughing during drilling. - upper 100 mm frozen. - test hole backfilled with soil auger cuttings and bentonite upon completion of drilling. - elevations based on survey information provided by client.	266.0								
5.0			265.0								
6.0			264.0								

ENG-TECH Consulting Limited

Logged by: RG

Reviewed by:

Drilled By: Paddock Drilling Limited

Drill Rig: Truck Mounted CT250

Auger Size: 125 mm solid stem

Completion Depth: 3.5 m

Completion Elevation: 266.5 m

Sheet: 1 of 1

SAMPLE TYPE



SPLIT BARREL



SHELBY TUBE



AUGER CUTTINGS



SPLIT SPOON



Engineering And Testing  
Solutions That Work For You

**Test Hole #: TH15**

Client: Burns Maendel Consulting

Site: East of Waldersee, Manitoba

Location: See Figure 7

Project: Geotechnical Investigation - New Rosedale Colony, Manitoba

File No.: 15-398-06

Date Drilled: December 16, 2015

Grade Elevation: 268.5 m

Water Elevation: - -

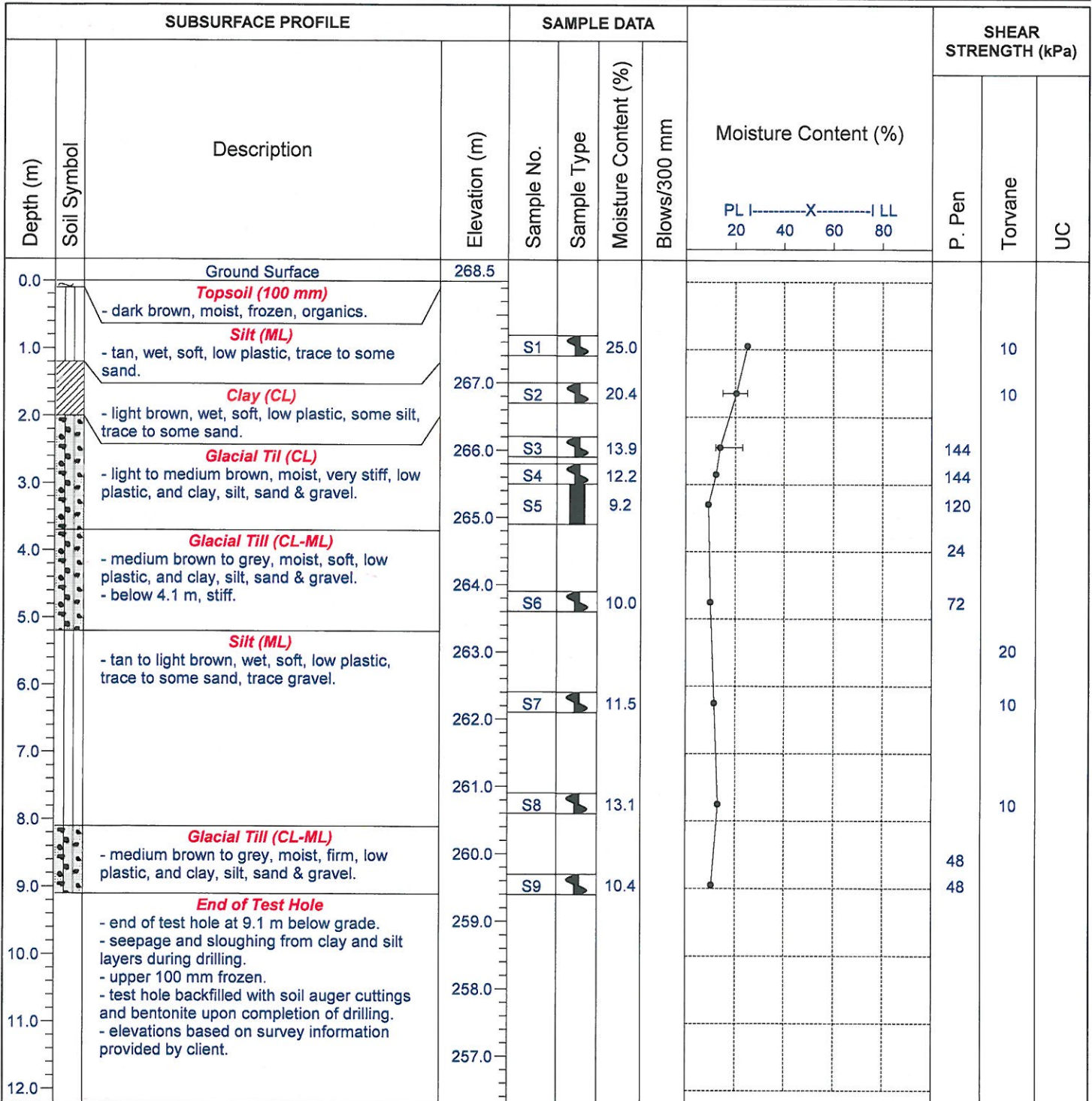

ENG- TECH Consulting Limited

Logged by: RG

Reviewed by: *CH*

Drilled By: Paddock Drilling Limited

Drill Rig: Truck Mounted CT250

Auger Size: 125 mm solid stem

Completion Depth: 9.1 m

Completion Elevation: 259.4 m

Sheet: 1 of 1

SAMPLE TYPE



SPLIT BARREL



SHELBY TUBE



AUGER CUTTINGS



SPLIT SPOON



Engineering And Testing  
Solutions That Work For You

**Test Hole #: TH16**

**Client:** Burns Maendel Consulting

**Site:** East of Waldersee, Manitoba

**Location:** See Figure 7

**Project:** Geotechnical Investigation - New Rosedale Colony, Manitoba

**File No.:** 15-398-06

**Date Drilled:** December 16, 2015

**Grade Elevation:** 268.5 m

**Water Elevation:** - -

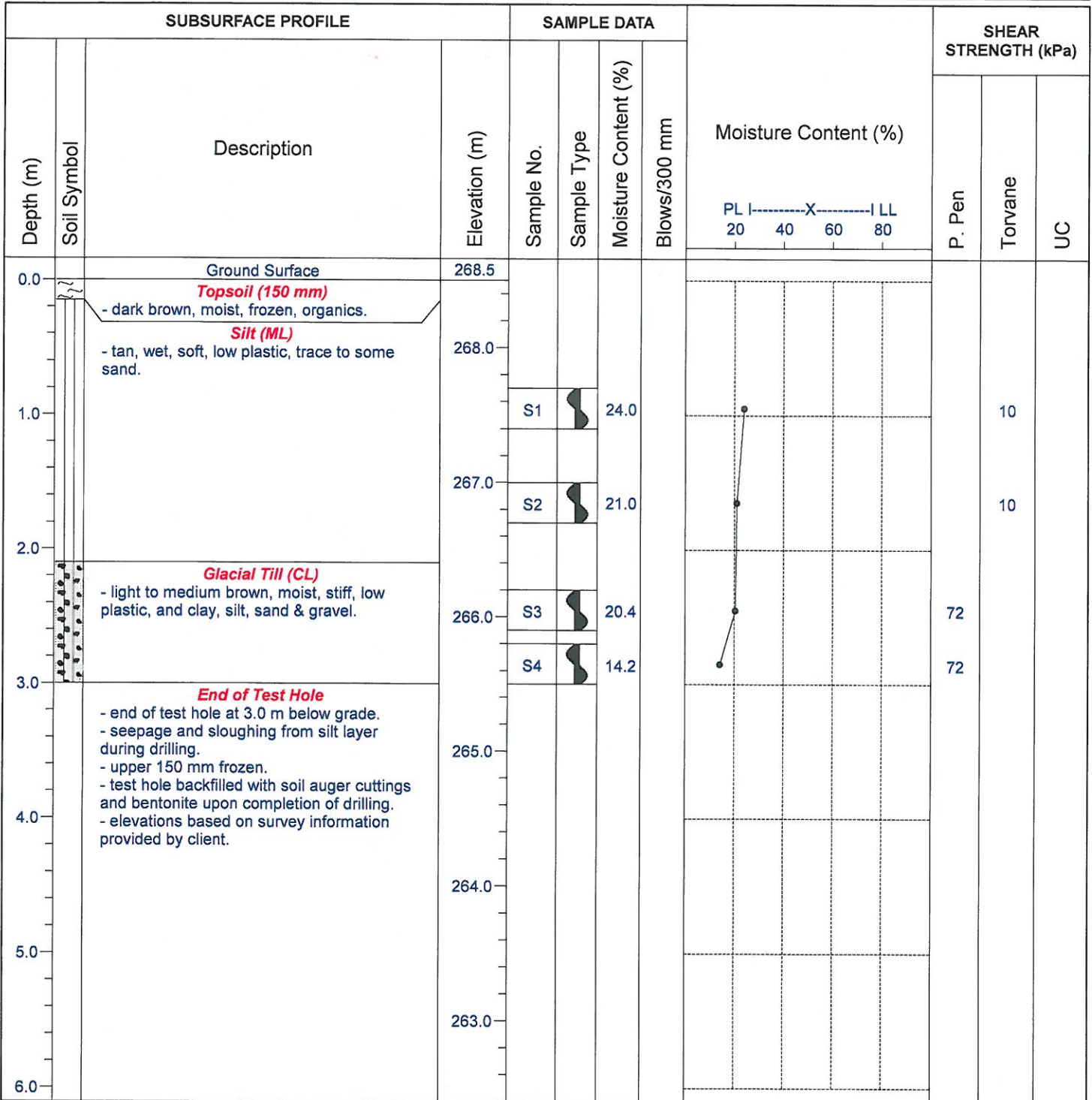

ENG- TECH Consulting Limited

Logged by: RG

Reviewed by: CA

Drilled By: Paddock Drilling Limited

Drill Rig: Truck Mounted CT250

Auger Size: 125 mm solid stem

Completion Depth: 3.0 m

Completion Elevation: 265.5 m

Sheet: 1 of 1

SAMPLE TYPE



SPLIT BARREL



SHELBY TUBE



AUGER CUTTINGS



SPLIT SPOON





**Engineering And Testing  
Solutions That Work For You**

**Test Hole #: TH17**

**Client:** Burns Maendel Consulting

**Site:** East of Waldersee, Manitoba

**Location:** See Figure 7

**Project:** Geotechnical Investigation - New Rosedale Colony, Manitoba

**File No.:** 15-398-06

**Date Drilled:** December 16, 2015

**Grade Elevation:** 269.2 m

**Water Elevation:** - -

SUBSURFACE PROFILE				SAMPLE DATA				SHEAR STRENGTH (kPa)				
Depth (m)	Soil Symbol	Description	Elevation (m)	Sample No.	Sample Type	Moisture Content (%)	Blows/300 mm	Moisture Content (%)				
								PL	X	LL	P. Pen	Torvane
0.0		<b>Ground Surface</b> <b>Topsoil (150 mm)</b> - dark brown, moist, frozen, organics.	269.2									
		<b>Silt (ML)</b> - tan, wet, soft, low plastic, trace to some sand.										
1.0		<b>Glacial Till (CI)</b> - light to medium brown, moist, stiff, medium plastic, and clay, silt, sand & gravel.	268.0	S1		26.9					10	
		<b>Glacial Till (CL-ML)</b> - medium brown to grey, moist, very stiff, low plastic, and clay, silt, sand & gravel.		S2		16.2					72	
2.0		<b>Glacial Till (CL-ML)</b> - below 2.6 m, stiff.	267.0	S3		12.0					96	
		- below 2.6 m, stiff.		S4		9.5					120	
3.0		- below 3.0 m, very stiff.	266.0	S5		8.5					72	
				S6		9.7	19					
4.0		<b>End of Test Hole</b> - end of test hole at 3.5 m below grade. - seepage and sloughing from silt layer during drilling. - upper 150 mm frozen. - test hole backfilled with soil auger cuttings and bentonite upon completion of drilling. - elevations based on survey information provided by client.	265.0									
5.0			264.0									
6.0												

ENG-TECH Consulting Limited

Logged by: RG

Reviewed by:

Drilled By: Paddock Drilling Limited

Drill Rig: Truck Mounted CT250

Auger Size: 125 mm solid stem

Completion Depth: 3.5 m

Completion Elevation: 265.7 m

Sheet: 1 of 1

SAMPLE TYPE



SPLIT BARREL



SHELBY TUBE



AUGER CUTTINGS



SPLIT SPOON



## Appendix C – Certificate of Title

## STATUS OF TITLE

Title Number **2517252/3**  
Title Status **Accepted**  
Client File **Feb 16 - 18th**

## The Property Registry

A Service Provider for the Province of Manitoba



### 1. REGISTERED OWNERS, TENANCY AND LAND DESCRIPTION

NEW ROSEDALE HOLDING CO. LTD.

IS REGISTERED OWNER, SUBJECT TO SUCH ENTRIES RECORDED  
HEREON IN THE FOLLOWING DESCRIBED LAND:

THE SE 1/4 OF SECTION 21-18-11 WPM  
EXC ALL MINES AND MINERALS AS SET FORTH  
IN THE ORIGINAL GRANT FROM THE CROWN

The land in this title is, unless the contrary is expressly declared, deemed to be subject to the reservations and restrictions set out in section 58 of *The Real Property Act*.

### 2. ACTIVE INSTRUMENTS

Instrument Type: **Mortgage**  
Registration Number: **1142149/3**  
Instrument Status: **Accepted**

Registration Date: 2011-03-22  
From/By: NEW ROSEDALE HOLDING CO. LTD.  
To: ROYAL BANK OF CANADA

Amount: \$3,700,000.00  
Notes: No notes  
Description: No description

### 3. ADDRESSES FOR SERVICE

NEW ROSEDALE HOLDING CO. LTD.  
BOX 460  
PORTAGE LA PRAIRIE MB  
R1N 3B7

### 4. TITLE NOTES

No title notes

### 5. LAND TITLES DISTRICT

Portage la Prairie

<b>6. DUPLICATE TITLE INFORMATION</b>
Duplicate not produced
<b>7. FROM TITLE NUMBERS</b>
2030293/3          All
<b>8. REAL PROPERTY APPLICATION / CROWN GRANT NUMBERS</b>
No real property application or grant information
<b>9. ORIGINATING INSTRUMENTS</b>
Instrument Type: <b>Transfer Of Land</b>
Registration Number: <b>1142148/3</b>
Registration Date:          2011-03-22
From/By:                    LORTZ ISLAND FARMS LTD.
To:                            NEW ROSEDALE HOLDING CO. LTD.
Consideration:              \$1.00
<b>10. LAND INDEX</b>
SE 21-18-11W EX RES

CERTIFIED TRUE EXTRACT PRODUCED FROM THE LAND TITLES DATA STORAGE SYSTEM OF TITLE NUMBER 2517252/3



## Appendix D – Manitoba Conservation Data Centre Correspondence

## Jeff Amundson

---

**From:** Friesen, Chris (CWS) [Chris.Friesen@gov.mb.ca]  
**Sent:** Friday, December 04, 2015 2:19 PM  
**To:** Jeff Amundson  
**Subject:** New Rosedale Colony - Domestic Wastewater Lagoon

Jeff

Thank you for your information request. I completed a search of the Manitoba Conservation Data Centre's rare species database and found no occurrences at this time for your area of interest.

The information provided in this letter is based on existing data known to the Manitoba Conservation Data Centre at the time of the request. These data are dependent on the research and observations of CDC staff and others who have shared their data, and reflect our current state of knowledge. An absence of data in any particular geographic area does not necessarily mean that species or ecological communities of concern are not present; in many areas, comprehensive surveys have never been completed. Therefore, this information should be regarded neither as a final statement on the occurrence of any species of concern, nor as a substitute for on-site surveys for species as part of environmental assessments.

Because the Manitoba CDC's Biotics database is continually updated and because information requests are evaluated by type of action, any given response is only appropriate for its respective request. Please contact the Manitoba CDC for an update on this natural heritage information if more than six months pass before it is utilized.

Third party requests for products wholly or partially derived from Biotics must be approved by the Manitoba CDC before information is released. Once approved, the primary user will identify the Manitoba CDC as data contributors on any map or publication using Biotics data, as follows as: Data developed by the Manitoba Conservation Data Centre; Wildlife Branch, Manitoba Conservation and Water Stewardship.

This letter is for information purposes only - it does not constitute consent or approval of the proposed project or activity, nor does it negate the need for any permits or approvals required by the Province of Manitoba.

We would be interested in receiving a copy of the results of any field surveys that you may undertake, to update our database with the most current knowledge of the area.

If you have any questions or require further information please contact me directly at (204) 945-7747.

Chris Friesen  
Coordinator  
Manitoba Conservation Data Centre  
204-945-7747  
[chris.friesen@gov.mb.ca](mailto:chris.friesen@gov.mb.ca)  
<http://www.gov.mb.ca/conservation/cdc/>

-----Original Message-----

From:  
Sent: November-27-15 11:25 AM  
To: Friesen, Chris (CWS)  
Subject: WWW Form Submission

Below is the result of your feedback form. It was submitted by WWW Information Request () on Friday, November 27, 2015 at 11:24:38

---

DocumentID: Manitoba\_Conservation

Project Title: New Rosedale Colony - Domestic Wastewater Lagoon

Date Needed: 2015/12/11

Name: Jeff Amundson

Company/Organization: Burns Maendel Consulting Engineers Ltd.

Address: 1331 Princess Avenue

City: Brandon

Province/State: Manitoba

Phone: (204) 728-7364

Fax: (204) 728-4418

Email: [j.amundson@bmce.ca](mailto:j.amundson@bmce.ca)

Project Description: We are looking to design a wastewater treatment lagoon on behalf of New Roseland Colony. The information will be included in an EAP to indicate impact on the local environment.

Information Requested: We would like to be aware of any protected or endangered species in the listed quarter section.

Format Requested: Microsoft Word Document or PDF

Location: SE 21-18-11 WPM

action: Submit

---



## Appendix E – Watershed Drains



647.5 SQ. MI.  
1677.0 SQ. KM.

DATE OF REVISION	REVISION	INITIAL

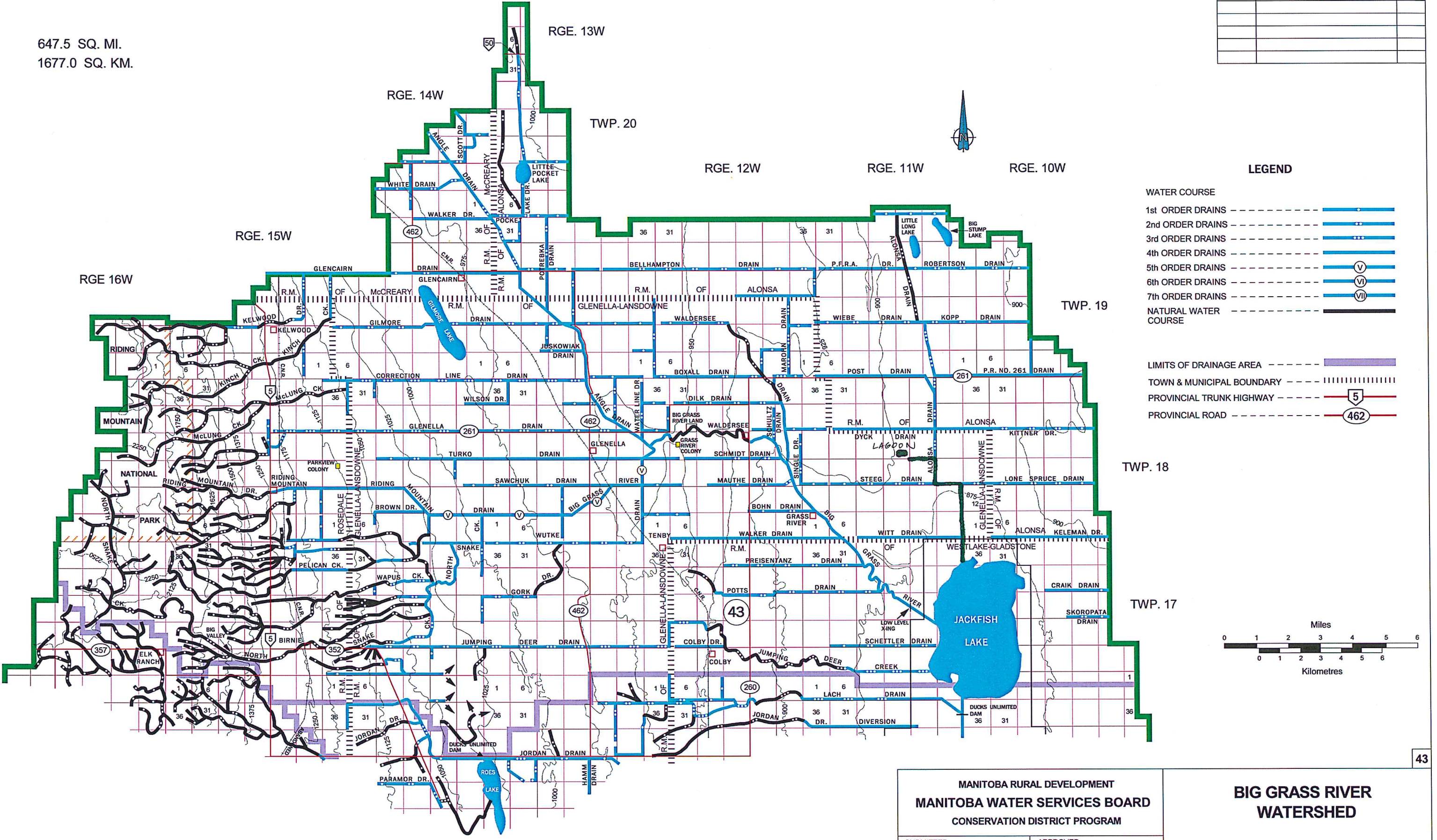

**LEGEND**

<b>WATER COURSE</b>	
1st ORDER DRAINS	---
2nd ORDER DRAINS	---
3rd ORDER DRAINS	---
4th ORDER DRAINS	---
5th ORDER DRAINS	---
6th ORDER DRAINS	---
7th ORDER DRAINS	---
NATURAL WATER COURSE	---
<b>LIMITS OF DRAINAGE AREA</b>	
TOWN & MUNICIPAL BOUNDARY	---
PROVINCIAL TRUNK HIGHWAY	---
PROVINCIAL ROAD	---

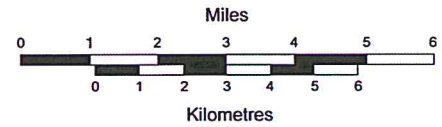

<b>MANITOBA RURAL DEVELOPMENT MANITOBA WATER SERVICES BOARD CONSERVATION DISTRICT PROGRAM</b>		<b>BIG GRASS RIVER WATERSHED</b>	
SUBMITTED:	APPROVED:	SCALE:	DATE:
		SHEET:	FILE NO.