

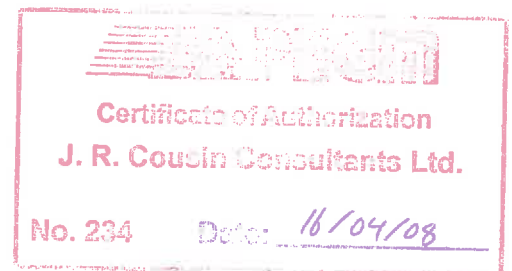

TOWN OF ALTONA
Environment Act Proposal
for the
Waste Disposal Ground Expansion

Prepared by:

Oswald Wohlgemut, M.Sc.
Environmental Scientist

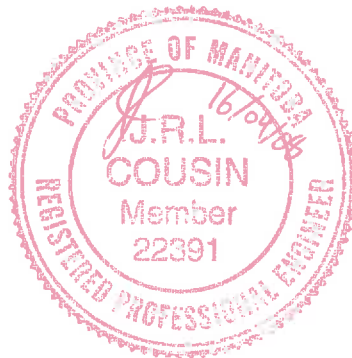

Reviewed by:

Jason Cousin, P.Eng.
Senior Municipal Engineer

April 2016



ACKNOWLEDGMENTS

To prepare this report various sources of information were investigated and researched. JR Cousin Consultants Ltd. (JRCC) wishes to thank the Town of Altona who contributed to the data and content of this report. In addition, we wish to commend the Town of Altona officials for their fortitude in addressing the need for a long-term solution to solid waste disposal for the residents of Altona and the Municipality of Rhineland.

REMARKS

JR Cousin Consultants Ltd. has conducted this environment act proposal in accordance with generally accepted professional engineering principles and practices for the purpose of identifying conditions that may have an environmental impact on the site. The findings and recommendations reached in this report are based on information made available to JRCC during the investigation and conditions at the time of the site investigation. Conclusions derived in this report are intended to reduce, but not wholly eliminate the uncertainty regarding potential environmental concerns on the site, and recognizes reasonable limitations with regards to time, accuracy, work scope and cost. It is possible that environmental conditions may change from the date of this report. If conditions appear different from those encountered and expressed in this report, JRCC should be informed so that mitigation recommendations can be reviewed and adjusted as required. Historical data and information obtained from personal communication used in this report, are assumed to be correct, however JRCC has not conducted further investigations into the accuracy of this data. JRCC has produced this report for the use of the client, and takes no responsibility for any third party decisions or actions based on information contained in this report.

TABLE OF CONTENTS

Section	Page of Section
ENVIRONMENT ACT PROPOSAL FORM	i
EXECUTIVE SUMMARY	1
1.0 INTRODUCTION AND BACKGROUND	1
1.1 Introduction	1
1.2 Contact Information	1
1.3 Background Information	1
1.4 Existing Facility	2
1.5 Existing Site Operations	3
1.6 Existing Operating Permit	3
1.7 Description of Previous Studies	3
1.8 Project Description and Schedule	4
2.0 DESCRIPTION OF THE DEVELOPMENT	1
2.1 Land Title/Location	1
2.2 Owner of Land and Mineral Rights	1
2.3 Existing Land Use	1
2.4 Land Use Designation/Zoning Designation	2
2.5 Description of Development	2
2.5.1 Project Schedule	2
2.5.2 Basis for Proposed WDG Expansion Site Selection	2
2.5.3 Projected Service Population	4
2.5.3.1 Town of Altona	4
2.5.3.2 Town of Gretna	4
2.5.3.3 LUD of Rosenfeld	4
2.5.3.4 Municipality of Rhineland	4
2.5.3.5 Other Contributing Populations	5
2.5.3.6 Population Summary Table	5
2.5.4 Projected Waste Generation	5
2.5.4.1 Solid Waste Density	6
2.5.4.2 Recycling	6
2.5.4.3 Compost	6
2.5.4.4 Burnable Materials	6
2.5.4.5 Waste Generation (Residential, Commercial and Industrial)	7
2.5.4.6 Waste Generation Summary Table	8
2.5.5 Topography and Geotechnical Review	8
2.5.5.1 Background Geotechnical Information	8
2.5.5.2 Onsite Geotechnical Investigation	10
2.5.5.3 Topography	13
2.5.6 Groundwater Elevation and Flow Direction	13
2.5.7 Groundwater Quality	14
2.5.8 WDG Cell Liner Requirements	17
2.5.9 Contaminant Migration	17

Section	Page of Section
2.5.10	Conceptual Design..... 18
2.5.10.1	Proposed Development..... 18
2.5.10.2	Storage Requirements 19
2.5.10.3	Conceptual Liner Design..... 20
2.5.10.4	Cover System..... 21
2.5.10.5	Leachate Management System..... 21
2.5.10.6	Monitoring Wells..... 23
2.5.10.7	Drainage..... 23
2.5.10.8	Access Road 24
2.5.10.9	Fencing and Signage..... 24
2.5.10.10	Compounds 24
2.5.11	Construction Techniques..... 25
2.5.12	Decommissioning and Closure..... 26
2.5.13	WDG Maintenance and Operation..... 26
2.5.14	Compost Operation and Maintenance..... 27
3.0	POTENTIAL ENVIRONMENTAL IMPACTS..... 1
3.1	Releases to Air, Water, Land 1
3.1.1	Air..... 1
3.1.2	Water..... 1
3.1.3	Land 1
3.2	Wildlife 2
3.3	Fisheries..... 2
3.4	Vegetation and Forestry..... 2
3.5	Noise Impacts 3
3.6	Health and Safety 3
3.7	Heritage Resources..... 3
3.8	Socio-Economic Implications 3
3.9	Aesthetics 4
4.0	MANAGEMENT PRACTICE..... 1
4.1	Mitigation of Impacts to Air 1
4.2	Mitigation of Impacts to Water 1
4.3	Mitigation of Impacts to Land..... 2
4.4	Mitigation of Impacts to Vegetation 2
4.5	Mitigation of Noise Impacts 2
4.6	Mitigation of Impacts to Health and Safety..... 2
4.7	Mitigation of Impacts to Heritage Resources 3
4.8	Aesthetics 3
5.0	RESIDUAL AND CUMULATIVE EFFECTS..... 1
6.0	MONITORING AND FOLLOW-UP..... 1
7.0	FUNDING AND APPROVALS..... 1
8.0	PUBLIC CONSULTATION..... 1
9.0	CONCLUSION..... 1

[Appendix A](#)

Status of Title

Crown Lands & Property Agency - Lands Branch, November 16, 2015 Email Correspondence

[Appendix B](#)

Table 1: Population and Waste Generation Projections – Altona Waste Disposal Ground

Manitoba Conservation and Water Stewardship - Wildlife and Ecosystem Protection Branch, September 9, 2015
Email Correspondence

[Appendix C](#)

Test Hole Logs

AMEC Foster Wheeler Soils Analysis Report, October 28, 2015

AMEC Foster Wheeler Soils Analysis Report, December 11, 2015

ALS Test Results, August 31, 2015

[Appendix D](#)

Title Page

Plan 1: Site Location Plan with Required Setbacks

Plan 2: Waste Disposal Ground Expansion Site with Test hole Location Plan

Plan 3: Proposed Waste Disposal Ground Expansion Layout and Drainage Plan

Plan 4: Dike, Liner, Leachate Pipe and Manhole Details

Plan 5: Road, Ditch, Fence, Silt Fence, Compost Pad and Sign Details

Plan 6: Site Operations Plan

Environment Act Proposal Form

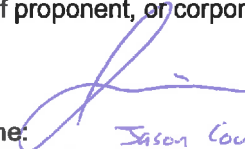

Name of the development: Altona Waste Disposal Ground Expansion	
Type of development per Classes of Development Regulation (Manitoba Regulation 164/88): Class 2	
Legal name of the applicant: Town of Altona and Municipality of Rhineland	
Mailing address of the applicant: 111 Centre St., Box 1630	
Contact Person: Mr. Dan Gagne	
City: Altona	Province: Manitoba Postal Code: R0G 0B0
Phone Number: (204) 324-6468	Fax: (204) 324-1550 email: Dan.Gagne@altona.ca
Location of the development: Municipality of Rhineland	
Contact Person: Mr. Dan Gagne	
Street Address:	
Legal Description: SE 27-2-1 WPM	
City/Town: Altona	Province: Manitoba Postal Code: R0G 0B0
Phone Number: (204) 324-6468	Fax: (204) 324-1550 email: Dan.Gagne@altona.ca
Name of proponent contact person for purposes of the environmental assessment: Jason Cousin, JR Cousin Consultants Ltd.	
Phone: 204-489-0474 Fax: 204-489-0487	Mailing address: 91 A Scurfield Blvd Winnipeg, Manitoba R3Y1G4
Email address: jrcousin@jrcc.ca	
Webpage address: www.jrcc.ca	
Date: April 6, 2016	Signature of proponent, or corporate principal of corporate proponent: 
	Printed name: Jason Cousin

EXECUTIVE SUMMARY

General

The Town of Altona and the Municipality of Rhineland are proposing the expansion of the existing Class 2 waste disposal ground (WDG) located at SE 27-2-1 WPM in the Municipality of Rhineland, Manitoba. An Environment Act Licence will be required from Manitoba Conservation for the expansion and continued operation of the (WDG) as a Class 1 facility. JR Cousin Consultants Ltd. (JRCC) was retained for the engineering services.

Project Background and Description

The existing WDG is in need of expansion cells to continue servicing the residents throughout the communities and rural areas in the Municipality of Rhineland. Expansion cells on the WDG site were limited to the west side of the site, due to a nearby residence east of the WDG and the required setbacks. The existing WDG and proposed expansion area are located approximately 4.2 km northeast of the Town of Altona, Manitoba. The expansion area to the west is located on cleared agricultural land, with Municipal Road 10 NW bordering the site to the south and agricultural land surrounding the property on all sides. A new compost pad will also be constructed on the south side of the WDG property with a separate approach off of Municipal Road 10 NW. The existing WDG consists of an active cell, several decommissioned cells, recyclable materials compounds, a used oil collection building, burn cells, abandoned soap stock cells, a weigh scale, equipment storage buildings and an operator building.

The proposed WDG expansion would include constructing an initial expansion cell with a 10 year life expectancy on the west side of the property, and future waste disposal cells over active and decommissioned cells on the north side of the property. The expansion area would provide a life expectancy over a total design period of 25 years. The expansion would also include construction of a leachate evaporation pond and associated ditching, fencing and access roads.

Population and Waste Generation

The projected year 25 service population utilizing the Altona WDG includes residents within the Towns of Altona and Gretna, the Local Urban District (LUD) of Rosenfeld, and the surrounding rural Municipality of Rhineland, which includes the residential, commercial, industrial and institutional populations. The Town of Plum Coulee, also located in the Municipality, operates a separate WDG and therefore, was not included in the population and waste generation projections. Curbside waste collection is available to residents in Altona and Gretna, while remaining residents in the Municipality utilize the WDG by individual drop off. The total year 25 design population was projected to be 11,798 people. Based on an average waste generation rate of 1.24 kg/person/day for the residential population and 0.94 kg/person/day for the rural residents in the Municipality, the total annual waste generation rate in design year 25 was estimated to be 10,183 m³/year.

Topography and Geotechnical Information

The land surrounding the existing waste disposal cells to the west and east was investigated for the location of the potential expansion cells. There were 15 test holes drilled around the WDG property for assessment of the soil and groundwater conditions. The general soil profile consisted of surficial black topsoil approximately 0.3 m thick, followed by a layer of high plastic clay soil to depths of 0.6 m – 2.5 m below the surface. Below were alternating layers of medium to high plastic silt and sand to depths of 1.5 m – 4.5 m below the surface, followed by high plastic clay to the bottom of the test holes. Small variations in the test holes included the thickness of the various

layers and the presence of sand. Bedrock was not encountered. The standing water level varied from 1.6 m to 5.4 m below the surface, in the majority of test holes.

The layers of high plastic clay and silty material found on the site were tested for permeability in an in situ state and after reworking. Based on the laboratory analysis, this material achieved hydraulic conductivity values less than 1×10^{-7} cm/sec. The requirements for a clay waste disposal cell liner, according to Manitoba Conservation, are a minimum 1.0 m thick clay liner achieving a consistent hydraulic conductivity of 1×10^{-7} cm/sec or less.

Liner Construction

The results of the soils investigation and permeability testing indicated that there is an unsuitable layer of sand near the surface in the majority of test holes, which would not be suitable for liner construction, however the high plastic clay and silt material found on the site would be suitable for use as a liner. Therefore, a vertical cut-off wall would be constructed of reworked clay and silt material around the perimeter of the proposed expansion area and would extend down below the layer of sand. This vertical cut-off wall would tie into the horizontal in situ high plastic clay material to form a continuous liner. The expansion cells and leachate pond would be constructed within this perimeter cut-off wall for containment of leachate within the WDG property. The compost pad would be constructed on an in situ horizontal liner of high plastic clay.

Cell Design Considerations

The dikes of the WDG expansion cells will be constructed of excavated soil material with 3H:1V interior slopes and dike tops 3.0 m wide. It is estimated that the expansion cell to the west will be constructed approximately 3.0 m below grade and waste will be extended to approximately 6.0 m above grade. The cells will be constructed with leachate collection piping in the floor, which will connect to a leachate collection manhole that will pump to the proposed leachate evaporation pond.

The leachate evaporation pond will be constructed to the south of the existing waste disposal cells on the site, within the perimeter cut-off wall and dike construction. The leachate pond will be designed to allow for evaporation of accumulated leachate liquid within the waste disposal cells.

The expansion cells and leachate pond will require perimeter ditching around the outside of the dikes and fencing surrounding the active areas for containment of litter and to prevent unauthorized entry.

Potential Concerns and Mitigation Measures

From discussions with the client and a review of the current site operations, the potential concerns identified with the expansion of the WDG and associated mitigation measures include:

Potential Concern	Mitigation Measure
Odours from expansion cells	The expansion site is beyond required setbacks from residents and regular cover material will reduce nuisance odours.
Leachate contamination of surface and groundwater from expansion cells	Expansion cells will utilize a perimeter soil liner for containment of leachate and a leachate evaporation pond will be used for leachate storage onsite.

Potential Concern	Mitigation Measure
Windblown litter impacting surrounding land	Fencing will be placed around the perimeter of the active areas to contain windblown litter on the WDG property.
Soil erosion after construction of expansion cells	Areas with bare soil outside of the expansion cells will be seeded with grass to reduce erosion.
Spills or leaks during construction	Contractor to have emergency spill kit on site. Hazardous materials and fuel to be handled in accordance with all federal and provincial regulations.
Reduce aesthetics of area	Slopes will be seeded after construction and the site will be regularly cleaned up of litter to maintain aesthetics and reduce visual impacts from the access road.
Health and safety	Construction workers will be required to adhere to the safety program which will include utilizing personal protective equipment while on site. Access to the active face of the expansion cells will be restricted to WDG staff.

Schedule and Approvals

The Town of Altona and the Municipality of Rhineland would like to begin development of the expansion area cell within two years, as the existing waste disposal cell is nearing capacity. The Municipality would like to construct the compost pad in the fall of 2016. No additional approvals, licences or permits are expected for the works, beyond the Environment Act Licence from Manitoba Conservation.

1.0 INTRODUCTION AND BACKGROUND

The development described herein is for the construction of expansion cells and continued operation of the existing waste disposal ground (WDG) near Altona, Manitoba.

1.1 Introduction

The Town of Altona and the RM of Rhineland are proposing the expansion of the existing Class 2 WDG located at SE 27-2-1 WPM in the Municipality of Rhineland, Manitoba. The conceptual design of the WDG expansion would be based upon a projected year 25 service population for residents in the Town of Altona and the Municipality of Rhineland. An Environment Act Licence is required from Manitoba Conservation for the construction and continued operation of the expanded facility, which would be considered a Class 1 facility in the future. JR Cousin Consultants Ltd. (JRCC) was retained for the engineering services.

1.2 Contact Information

Mr. Jason Cousin, P.Eng.
JR Cousin Consultants Ltd.
91A Scurfield Blvd.
Winnipeg, Manitoba
R3Y 1G4
Phone (204) 489-0474, Fax (204) 489-0487

Mr. Dan Gagne, CAO
Town of Altona
111 Centre Ave
Box 1630
Altona, Manitoba
R0G 0B0
Phone (204) 324-6468, Fax (204) 324-1550

1.3 Background Information

The Altona WDG is located approximately 4.2 km northeast of the Town of Altona, Manitoba (see Plan 1 attached in Appendix D). The existing WDG is jointly owned and operated by the Town of Altona and the Municipality of Rhineland, and services the residents in the surrounding towns, and villages and rural residents in the municipality. The existing WDG site has been in operation since the early 1970s, and is operating under Operating Permit No. RRR-030. Curbside waste pick up is being utilized in Altona and Gretna, while rural residents in the Municipality drop off waste individually. The site is located along Road 10 NW, in the Municipality of Rhineland. The land surrounding the existing WDG is agricultural land used for crop production.

1.4 Existing Facility

The existing WDG currently operates with the following compounds/facilities:

- Active waste disposal cell – below and above grade cell with surrounding dikes approximately 4.0 m above floor of cell.
- Soap stock storage cells – five abandoned cells with depths of approximately 3.5 m from the floor to the top of dike, once used for storing soap stock, a residual from Bunge vegetable oil refining operations. Currently two of these cells still have liquid waste material, while the remaining cells have been dewatered, with residual materials on the cell floor.
- Burn cells – two above grade cells for burning untreated lumber, wood waste and cardboard. The cells are surrounded on three sides by a berm approximately 1.6 m above the cell floors.
- Soil stockpiles – stockpiles of soil used as cover material in the active waste disposal cell.
- Used oil eco-centre – concrete building structure housing a used oil tank and bin for used oil filters and containers.
- Metals storage – designated above ground area for scrap metals and appliances. A roll-off bin was used for containment in the area.
- Tires storage – designated above ground area for used tires.
- Used telephone poles – above ground area for used telephone poles.
- Chemical containers – above ground, fenced-in and graveled compound for used chemical containers with a low-lying catchment pond for runoff.
- Used shingles – a portion of the active waste disposal cell segregated for shingles.
- Construction waste storage – above ground area for used concrete and demolition waste.
- Propane and battery storage – above ground area for used propane tanks and car batteries.
- Yard waste – above ground area used for yard waste collected by a local private contractor. This material is burned periodically.
- Operator building – a heated operator building with electrical power, running water, a wastewater holding tank, electricity, telephone and internet communications.
- Equipment storage buildings – one heated and one unheated, storage and maintenance building for site equipment and materials.

The site also has the following features:

- a perimeter fence (1.8 m high) of fixed knot game fencing surrounding the active portion of the property and around the waste disposal cell, chemical containers compound and soap stock cells
- three groundwater monitoring wells located around the perimeter of the property, installed in August 2015
- an internal access road (5.5 m wide) of compacted granular material
- a lockable entrance gate

- site signage (i.e. entrance sign and drop off location signs)
- a certified weigh scale at the entrance to the site for recording incoming waste tonnage and issuing tipping fees
- an above ground fuel tank (i.e. diesel fuel) for equipment refueling.

1.5 Existing Site Operations

The existing WDG is operated with a below and above ground active waste disposal cell and several areas and other cells used for material separation, storage, burning and recycling. During daily operations, the site has a gate attendant who handles tipping fees and directs individuals to the appropriate drop off locations, while a site operator conducts general site cleanup and waste movement, compaction and covering (weekly). The site has a tracked loader and a steel wheeled landfill compactor/dozer, which are dedicated for the site maintenance and are used for waste movement, compaction and covering.

The recyclable materials stored on the site (i.e. tires, metals and chemical containers) are hauled away when the storage areas are nearing capacity. The used oil tank is emptied and hauled away by a licensed hazardous waste hauler when it reaches capacity. The ashes in the burn cells are removed and deposited in the waste disposal cell. The interior site access roads, compounds and cells are maintained and cleared of snow throughout the winter to allow continued access to the site by the public during operating hours. The soap stock cells were currently being emptied by the WDG operator during the site investigation. The heavy equipment is maintained and stored in the heated equipment storage building. Leachate generated in the waste disposal cell is periodically pumped out and drained onto decommissioned cells on the site.

1.6 Existing Operating Permit

The WDG is operating under the current operating permit (No. RRR-030), which has provisions for the following:

- solid waste covering on a monthly basis
- preventing disposal of liquid waste
- requirements for burning activities at the site.

1.7 Description of Previous Studies

A previous report entitled *Geotechnical Report – Bunge Soap Stock Storage Cells Altona Waste Disposal Grounds*, by AMEC Foster Wheeler (July 2015) was reviewed to obtain background information on the soil and groundwater conditions at the existing WDG. The report included an onsite topographic and geotechnical investigation for the existing soap stock cells at the WDG, and an evaluation of soils for cap and liner material.

The previous report entitled *Geotechnical Investigation for the Proposed New Weigh Scale to be Located at the Altona Landfill Site Situated on SE 27-2-1 W, near Altona, Manitoba*, by M. Block and Associates Ltd. (May 2013) was reviewed to obtain background geotechnical information. This report included a site investigation with test holes drilled to determine foundation requirements of a weigh scale.

The previous report entitled *Town of Altona Rural, Municipality of Rhineland, Town of Gretna - Solid Waste Management Site Feasibility Study*, by KGS Group (July 2008) was reviewed to obtain background information on the WDG site conditions, service area and waste management practices.

1.8 Project Description and Schedule

As requested by the Town of Altona, the existing WDG site is in need of expansion waste disposal cells, in accordance with the current Operating Permit (No. RRR-030), and applicable provincial guidelines and regulations governing Class 1 WDG sites. The site expansion will be designed to handle the long-term waste generation from the service population in the town and municipality, to design year 25.

It is anticipated that the existing waste disposal cell has approximately two more years of capacity. After this time expansion cells will need to be constructed for continued use of the site. In addition, a compost pad would be constructed to replace the existing composting site in the Town of Altona.

2.0 DESCRIPTION OF THE DEVELOPMENT

For each heading there is an information request from the Environment Act Proposal Form. These requests are repeated herein in italics followed by the pertaining response.

2.1 Land Title/Location

Certificate of Title showing the owner(s) and legal description of the land upon which the development will be constructed; or, in the case of highways, rail lines, electrical transmission lines, or pipelines, a map or maps at a scale no less than 1:50,000 showing the location of the proposed development:

The existing WDG and proposed expansion site is located in SE 27-2-1 WPM, approximately 4.2 km northeast of the Town of Altona, Manitoba. The expansion area is a cleared portion of grassland to the west of the existing waste disposal cells. The lands surrounding the proposed expansion area are agricultural, with Road 10 NW bordering the site to the south.

The legal description of the land is divided into Parcel I under Plan 1343 MLT0 and Parcel II under Plan 2137 MLT0. The land parcel is currently owned jointly by the Town of Altona and the Municipality of Rhineland under certificate of title number 2581984/4 (attached in Appendix A).

2.2 Owner of Land and Mineral Rights

Owner of land upon which the development is intended to be constructed, and of mineral rights beneath the land, if different from surface owner:

The Crown Lands & Property Agency was contacted regarding the ownership of the mines and minerals at the proposed development location. According to the Crown Lands & Property Agency, the ownership of sand and gravel, and mines and minerals remains with the surface title (owned by the Town of Altona and the Municipality of Rhineland)(see email correspondence from the Crown Lands & Property Agency in Appendix A).

2.3 Existing Land Use

Existing land use on the site and on land adjoining it, as well as changes that will be made in such land use for the purposes of the development:

The area of the proposed expansion cells is currently used as agricultural land for alfalfa crops, while the area for the compost cell and borrow soils is grassland maintained by the site operator. The surrounding adjacent lands are agricultural and are currently being used for crop production. The nearest residence is a farmyard located approximately 210 m to the east of the property boundary. The town residential outskirts are located approximately 4.2 km to the southwest of the WDG property boundary (see Plan 1 in Appendix D).

2.4 Land Use Designation/Zoning Designation

Land use designation for the site and adjoining land as identified in a development plan adopted under The Planning Act or The City of Winnipeg Act, and the zoning designation as identified in a zoning by-law, if applicable:

Based on information provided by the Town of Altona, the WDG site is currently zoned as Agricultural 40 (A40), with a condition use for waste disposal grounds.

2.5 Description of Development

Description of proposed development and schedule for stages of the development, including proposed dates for planning, design, construction, commissioning, operation, and decommissioning and/or termination of operation (if known), identifying major components and activities of the development as applicable (e.g. access road, airstrip, processing facility, waste disposal area, etc.).

2.5.1 Project Schedule

The WDG expansion design is proposed to begin upon receipt of an Environment Act Licence. The expansion cell construction works are proposed to begin when the existing waste disposal cell is nearing capacity, while the construction of future expansion cells is not expected for several years, due to existing capacity in the current waste disposal cells. The compost cell is expected to be constructed in the fall of 2016. No date for decommissioning has been set for the WDG cells, however the expansion cells would be designed for a projected year 25 service population, and a WDG capacity assessment should be conducted as the WDG approaches this year 25 design life.

2.5.2 Basis for Proposed WDG Expansion Site Selection

The location for the WDG expansion cells was chosen based on discussions with the Town of Altona, with consideration of land availability and proximity to nearby rural residents, town residents and sensitive areas.

According to the *Guidelines for the Siting of a Class I Waste Disposal Ground in Manitoba* (1994), the siting of the WDG expansion cells would require the following provincial guidelines and minimum setback requirements:

- Watersheds with surface water flow through the site
- Sites underlain with sand, gravel, sandstone, limestone
- Sites on the edge of steep slopes, subject to erosion and land sliding
- Sites within 2 km of wetlands
- Bedrock outcrops
- Karst terrain
- Fractured bedrock

- Unstable terrain
- Areas of unpredictable geology
- Sites with shallow water tables or perched aquifers
- Groundwater pollution hazard areas
- Areas within 100 year flood plain
- Areas with limited access to roads or utilities
- Sites within 400 m of a residence
- Sites within 400 m of a potable water well
- Sites within 400 m of a cemetery
- Sites within 2 km of a critical habitat area
- Sites within 2 km of a designated park or historic site
- Sites within 100 m from a public road or railway right of way
- Sites within 1 km from a body of surface water
- Sites within 8 km of an airport or setback as described in the local zoning plan.

An important concern in evaluating Class I WDG sites is the protection of water quality, and human health and safety. The above setbacks also consider aesthetic qualities of the surrounding landscape and safety issues for nearby transportation routes. Plan 1 in Appendix D, shows the minimum setback requirements as described above.

The above siting requirements are established to ensure that if a WDG fails to adequately contain leachate, the site's natural conditions will protect groundwater and surface water resources, and control the migration of landfill gases. Preference should be given to sites located in areas where there is clay or till of low permeability (1×10^{-7} cm/sec or less) to ensure groundwater protection and minimal migration of landfill gases. If soils of sufficiently low permeability are not available, a geomembrane liner should be considered for containment.

Based on the proposed location of the Altona WDG expansion, there were no specific concerns identified regarding siting of an expansion at the existing WDG site. The distance to the nearest airstrip was reviewed with Transport Canada and the Municipality of Rhineland. The airstrip site is classified as an aerodrome and not an airport, therefore a specific setback distance is not regulated by Transport Canada. The municipality also did not have specific setback distance requirements for the aerodrome to the WDG site, and no concerns have been raised concerning air safety due to wildlife related to the existing WDG site. The WDG site is located approximately 5.6 km from the airstrip.

2.5.3 Projected Service Population

A review of the service population for the Altona WDG was conducted to assess the current and projected waste disposal requirements. The assessment was utilized to determine the sizing requirements for the proposed expansion cells, at the waste disposal ground.

Population data was obtained from Statistics Canada and from discussions with the Town of Altona. The service population utilizing the Altona WDG includes residents within the Towns of Altona and Gretna, the Local Urban District (LUD) of Rosenfeld, and the surrounding rural Municipality of Rhineland. There were currently no major industrial or commercial contributors to the WDG site identified by the town.

2.5.3.1 Town of Altona

Based on the latest census data from Statistics Canada, the Town of Altona had a population of 4,088 people in 2011. Based on a review of past census data for the town over the past 15 years, the population has been steadily increasing at an average annual growth rate of 1.55%. This growth rate was utilized to project current and future populations to design year 25. The current (2015) population was estimated to be 4,347 people, and the projected year 25 population was estimated to be 6,386 people.

2.5.3.2 Town of Gretna

Based on the latest census data from Statistics Canada, the Town of Gretna had a population of 556 people in 2011. Based on a review of past census data for the town over the past 15 years, the population has experienced increases and decreases, however the overall population has increased at an average annual growth rate of 0.22%. This growth rate was utilized to project current and future populations to design year 25. The current (2015) population was estimated to be 561 people, and the projected year 25 population was estimated to be 593 people.

2.5.3.3 LUD of Rosenfeld

Based on the latest census data from Statistics Canada, the LUD of Rosenfeld had a population of 348 people in 2011. Based on a review of past census data for the LUD over the past 5 years, which was the only historical census data available, the population has experienced an annual average growth rate of 0.5%. This growth rate was utilized to project current and future populations to design year 25. The current (2015) population was estimated to be 355 people, and the projected year 25 population was estimated to be 402 people.

2.5.3.4 Municipality of Rhineland

Based on the latest census data from Statistics Canada, the Municipality of Rhineland had a rural population of 4,373 people in 2011, which included the population of Rosenfeld (348 people). Based on a review of past census data for the municipality

over the past 15 years, the rural population has experienced increases and decreases, however the overall rural population has increased at an average annual growth rate of 0.32%. This growth rate was utilized to project current and future rural populations to design year 25. The current (2015) rural population (excluding Rosenfeld) was estimated to be 4,077 people, and the projected year 25 rural population was estimated to be 4,416 people.

2.5.3.5 Other Contributing Populations

There were no other large contributing populations or commercial/industrial sources not included in the above service population, based on information provided by the town. The Town of Plum Coulee was not included in the service population, as they operate a separate WDG and there are no immediate plans to decommission that facility.

2.5.3.6 Population Summary Table

The current and projected populations for the service area have been included in the summary table below and in the attached Table 1 (Appendix B).

Contributing Population	2011 Population	2015 Population	Year 25 Population
Town of Altona	4,088	4,347	6,386
Town of Gretna	556	561	593
LUD of Rosenfeld	348	355	402
Municipality of Rhineland	4,025	4,077	4,416
Total	9,017	9,340	11,797

If the growth rate of the service population varies from the projected values discussed above, it could impact the life span of the waste disposal cells as sized below. From discussions with the Town of Altona, it is possible that the population of Plum Coulee, rural residents from outside the municipality and commercial or industrial contributors could be added to the service population in the future. If this was the situation, then the expansion cells would have a lessened capacity and a shorter lifespan, however these populations were not considered in the service population.

2.5.4 Projected Waste Generation

The projected amount of solid waste generated by residents was estimated from the existing waste generation data recorded at the Altona WDG. The waste generation projections for the WDG site were based on the historical recorded tonnage of waste material received and an estimated solid waste density at the WDG site. Processed vegetable meal waste material from Bunge, is mixed with the household waste material in the active waste disposal cell. There are no other known significant waste-generating industries in the service area that contribute to the

waste disposal cell, therefore commercial/industrial waste generation sources have not been included separately, but rather are included in the overall waste generation numbers.

2.5.4.1 Solid Waste Density

A solid waste density of 300 kg/m³ is typical for compacted solid waste from a compacting collection truck, whereas a density of 175 kg/m³ is typical for an uncompacted waste. As both compacted and uncompacted waste is received at the WDG site, the determination of solid waste density was based on the compaction occurring onsite in the active waste disposal cell. The WDG utilizes a steel-wheeled waste compactor regularly, which can typically compact waste to a solid waste density of 475 kg/m³, if compaction occurs regularly. This density was utilized in estimating the volume of waste received in the waste disposal cells, as the operator indicated that compaction occurs regularly at the site.

2.5.4.2 Recycling

A recycling program is currently being operated by Blue Sky Opportunities, who are responsible for collection of recyclable materials for residents in the Municipality of Rhineland. Therefore, a minimal amount of recyclable material is dropped off at the WDG, such as scrap metals, used tires and used, plastic chemical containers. These recyclable materials are separated and hauled to various processing facilities when required. The recyclable material received at the WDG site is not included in the total waste tonnage reported below and is not being considered in the site expansion cells, as this material is regularly hauled off site for processing and it is assumed that the existing compounds/designated areas will continue to be utilized in the future. The town currently records weights of material recycled, as part of the Waste Reduction and Recycling Support (WRARS) program, and based on this recorded weight the recycled material composed approximately 8% of the total waste produced.

2.5.4.3 Compost

Compost is currently handled at a separate site in Altona, near the Public Works building, however the Municipality would like this compost area to move to the WDG site as soon as possible, as the current location is not ideal for the Municipality. As it is collected and stored separately, compostable material was also not included in the waste tonnage reported below. The compost material expected to be dropped off will typically consist of yard waste (i.e. leaves, grass, small branches). The Town does not record weights of the compost collected or dropped off, however it is estimated that the compost material composed approximately 11% of the total waste produced.

2.5.4.4 Burnable Materials

Burnable materials received at the WDG includes untreated lumber, yard waste and cardboard. In a 2010 waste analysis conducted by the town, burnable material was estimated to compose approximately 16% of the total waste produced. This value was

assumed for the continued operations at the WDG site, and was not included in the sizing of the expansion cells.

2.5.4.5 Waste Generation (Residential, Commercial and Industrial)

The WDG has utilized a weigh scale at the entrance to the site to record tonnes of waste hauled to the site for several years. The latest (2014) waste receiving records indicated that the site received 3,780 tonnes of residential, commercial and industrial waste from all sources in the service population. This is an annual increase in waste generation of approximately 1.1% per year from the records provided in 2011 (3,626 tonnes). The overall population growth rate was also similar and was therefore considered suitable for sizing the expansion cells to design year 25.

Statistics Canada (2012) indicates that a waste generation rate of 1.1 kg/person/day, in Manitoba, is typical for residential waste only, and 2.3 kg/person/day is typical for residential and non-residential (i.e. commercial, industrial, institutional) waste combined. These values however do not take into consideration waste diversion efforts through recycling, composting and burning. In general, residential populations tend to have higher per capita waste generation rates than rural residents, due to the accessibility of curbside waste collection in communities, whereas rural residents need to haul waste individually.

Based on the actual service population and recorded waste tonnage in 2011, the average per capita waste generation would be 1.15 kg/person/day. However, it was estimated that the residential population (i.e. Altona, Gretna, and Rosenfeld) would have a higher per capita waste generation rate, while rural residents would have a lower waste generation rate. From past records the RM estimated that approximately 62% of the total waste generation originates from the residential population and 38% from the rural population.

From estimates provided by the town the following are percentages of waste diversion materials making up the total waste stream:

- Burnable wood waste material makes up approximately 16%
- Compost material makes up approximately 11%
- Recycling material makes up approximately 8%.

A suitable per capita waste generation rate for the rural population was estimated to be 0.94 kg/person/day, which was considered to be household waste only, with partial recycling, compost and burnable material included. To make up the balance of the actual recorded values of waste tonnage received between 2011 and 2014, a per capita waste generation rate for the residential population was approximately 1.24 kg/person/day, based on the actual and estimated populations.

This per capita waste generation rate for the residential populations in the

Municipality is slightly lower than the Manitoba average of 1.5 kg/person/day, for residential and non-residential waste when considering the 35% waste diversion rate.

Utilizing waste generation rates of 1.24 kg/person/day for Altona, Gretna, and Rosenfeld, and 0.94 kg/person/day for rural residents, along with a solid waste density of 475 kg/m³ and the projected population growth rate, the estimated current annual volume of this waste received would 7,928 m³/year and would increase to 10,183 m³/year in design year 25. This waste generation rate was utilized for estimating storage requirements of the WDG expansion cells to design year 25.

2.5.4.6 Waste Generation Summary Table

The current and projected residential waste generation rates for the service area have been included in the summary table below and in the attached Table 1 (Appendix B).

Contributing Waste Source	Current Annual Waste Generation (m ³ /year)	Year 25 Annual Waste Generation (m ³ /year)
Residential, Commercial and Industrial	7,928	10,183

2.5.5 Topography and Geotechnical Review

An onsite geotechnical and topographical investigation was completed on August 27 and 28, 2015 to determine the suitability of the proposed development areas for the siting and construction works.

2.5.5.1 Background Geotechnical Information

Canada-Manitoba Soil Survey

Based on the existing detailed Canada-Manitoba soils survey report of the Rural Municipality of Rhineland (No. D-76, 1991), the soils in the existing WDG area are classified as:

- Plum Coulee series – Imperfectly drained, Gleyed Black soils developed on clayey and stratified clayey, moderately to strongly calcareous lacustrine and deltaic sediments. The topography is level to very gently sloping. These soils have slow permeability and moderately slow surface runoff.
- Deadhorse series – Imperfectly drained, Gleyed Rego Black soils developed on clayey, stratified clayey, moderately to strongly calcareous lacustrine and deltaic sediments. The topography is typically level to very gently sloping on undulating landscapes. These soils have very slow permeability, slow surface runoff and high water table during the growing season.

- Horndean series – Imperfectly drained, Gleyed Black soils developed on clayey, moderately to strongly calcareous lacustrine sediments overlying stratified coarse loamy to sandy strata. The topography is typically level to very gently sloping terrain. These soils have moderately slow to slow permeability, slow surface runoff and high water table in the spring.
- Red River series – Imperfectly drained Gleyed Rego Black soils developed on deep moderately to strongly calcareous clayey, lacustrine sediments. The topography is level to very gently sloping. These soils have slow permeability, slow to moderate surface runoff and a medium water table during the growing season.
- Morris series – Imperfectly drained, Gleyed Solonchic Black soils developed on deep moderately to strongly calcareous clayey, lacustrine sediments. The topography is level to very gently sloping terrain. These soils have very slow permeability and moderately slow surface runoff.
- Osborne series – Poorly drained Rego Humic Gleysol soils developed on deep moderately to strongly calcareous clayey, lacustrine sediments. The topography is depressional to level. These soils have very slow permeability, slow to very slow surface runoff and high water table during the growing season.

Native vegetation consists of prairie meadow grasses, reeds, aspen, oak and willow, however the majority of these soils are suitable for grain crop production. The soils survey report also described the hydrology of the region as having near surface aquifers of sand and silt layers with low yield, suitable for domestic or farm use only. The only significant fresh water aquifer formed by sand and gravel at 30 m to 40 m below the surface several kilometers west of the WDG site, known as the Winkler aquifer.

Past Geotechnical Investigation

Past geotechnical information was obtained from a review of the document entitled *Geotechnical Report – Bunge Soapstock Storage Cells Altona Waste Disposal Grounds*, by AMEC Foster Wheeler (July 2015). Six test holes were drilled on top of the dikes surrounding the soap stock storage cells. The typical soil profile consisted of high plastic clay fill between 0.9 m to 2.9 m below the surface, followed by a layer of low to medium plastic silt and clay to depths of 3.8 m to 4.6 m below grade. This layer was overlying high plastic clay, which extended to the bottom of the test holes (9.1 m below grade). Depth to groundwater infiltration ranged from 3.7 m to 4.6 m below grade, within the layer of silt. The soil conditions encountered were considered favorable for the onsite closure of the soap stock cells with excavated clay cover material.

A report from M. Block and Associates Ltd. (May 2013) entitled *Geotechnical Investigation for the Proposed New Weigh Scale to be Located at the Altona Landfill*

Site Situated on SE 27-2-1 W, near Altona, Manitoba was reviewed for background geotechnical information. During this study two test holes were drilled at the site entrance to a maximum depth of 18.9 m below the surface, to determine soil and groundwater conditions and the compressive strength of the soils for design of a weigh scale foundation. The typical soil profile consisted of surficial fill, followed by high plastic silty clay to the bottom of the test holes. One of the test holes contained a layer of low plastic clayey silt from approximately 1.5 m to 4.3 m below the surface. Groundwater was encountered in one test hole at a depth of 2.7 m below the surface.

2.5.5.2 Onsite Geotechnical Investigation

An onsite investigation of geotechnical conditions was conducted by JR Cousin Consultants Ltd. on August 27 and 28, 2015. A tracked drill rig was used for drilling test holes and installing groundwater monitoring wells under the direct supervision of JRCC personnel. The land immediately surrounding the existing WDG cells to the west (within the property boundary), was investigated as a proposed expansion area and the unused land to the east and south, also within the property boundary, was investigated as a potential borrow area. The land was investigated to determine whether the soils would be suitable for use as a clay WDG liner in an undisturbed state (in situ) or after reworking, and whether soils could be used for potential borrow material during construction.

During the site investigation, fifteen test holes were drilled to a maximum depth of 12.0 m below the surface. The groundwater monitoring wells were drilled to a depth of 4.5 m below the surface. The test hole locations are shown on Plan 2, attached in Appendix D.

The subsurface soil profile within each test hole was logged, water conditions were noted, and representative soil samples were collected as the soils varied along the profile. The samples were visually field-classified and confirmed through laboratory analysis. Shelby tubes of undisturbed in situ soil were collected in various test holes and at depths appropriate for a WDG cell liner. Bulk samples were also collected in various test holes and at various depths if testing of a reworked soil sample was deemed necessary. Following completion of the test holes, an assessment of the short term groundwater conditions was completed by measuring the static water level in the test holes and determining the elevation of water infiltration into the test holes. All test holes were then backfilled with excavated material. Details of each test hole soil profile, including depth and description of each soil layer, as well as comments on groundwater infiltration can be found in the test hole logs attached in Appendix C.

Soil Profile

Based on the soils observed in the test holes, the subsurface soil profile was generally consistent across the entire testing area. This does not represent areas previously disturbed by waste disposal activities.

The general soil profile consisted of a layer of surficial black topsoil approximately 0.3 m thick, followed by a layer of high plastic clay soil to depths of 0.6 m – 2.5 m below the surface. Below this were alternating layers of medium plastic silt and sand to depths of 1.5 m – 4.5 m below the surface, followed by high plastic clay to the bottom of the test holes. Small variations in the test holes included the thickness of the various layers and the presence of sand. The following table summarizes the general soil profile observed of the major soil types:

Primary Soil Type	Depth Range of Soil layer	Secondary Soil Characteristics
Topsoil	0 m – 0.3 m	clayey
Clay – high plastic	0.3 m – 2.5 m	silty
Silt and Sand – low plastic	0.7 m – 4.5 m	clayey, wet
Clay – high plastic	1.5 m – 12 m	silty

Details of the soil profile in each test hole can be found in the test hole logs, attached in Appendix C.

Groundwater and Bedrock

Water infiltration and short-term water accumulation was recorded in the test holes during the test hole excavation and prior to backfilling. The moisture content in the silt and sand layer observed at the site was higher than the clay soils, indicating that this layer would be transmitting groundwater. The standing water level in the test holes is influenced by several factors, such as seasonal conditions, rate of groundwater flow, depth of test holes, etc., however the presence of standing water can be an indication of potential challenges during construction. The standing water level varied from 1.6 m to 5.4 m below the surface, in the majority of test holes.

In general, the majority of the test holes experienced caving conditions, likely due to the silty and sandy layers in the soil profile. Refusal or bedrock was not encountered at any of the test holes.

Laboratory Analysis

Representative soil samples from the site were submitted to AMEC Foster Wheeler for testing and analysis. The following is a summary of the testing results, while details of soils analysis and testing results from the laboratory are attached in Appendix C.

Five bagged samples representative of site soil conditions were analyzed for the

following:

- Atterberg Limits (plastic limit, liquid limit, and plasticity index, ASTM D4318)
- Soil Classification (ASTM D2487)
- Moisture Content (ASTM D2216)
- Particle Size Analysis (Hydrometer test, ASTM D422).

One representative Shelby tube sample was tested for:

- Hydraulic Conductivity (ASTM D5084).

In addition, one representative bulk sample was tested for:

- Standard Proctor Density (ASTM D698)
- Reworked Hydraulic Conductivity (ASTM D5084).

The five bagged soil samples analyzed were from the following test holes:

- TH2 1.2 m – 2.4 m
- TH4 0.2 m – 0.7 m
- TH5 0.4 m – 2.0 m
- TH5 3.2 m – 6.0 m
- TH12 0.3 m – 0.8 m.

The Shelby tube sample analyzed was from the following test hole:

- TH5 1.5 m – 2.1 m.

The bulk sample analyzed was from the following test hole:

- TH12 0.3 m – 0.8 m.

JRCC requested that the laboratory also provide an assessment, based on the analysis and the testing, as to whether the soil samples could achieve a permeability of 1×10^{-7} cm/sec or less in their in situ and reworked states. A summary of the laboratory results are as follows:

Sample ID	Soil Classification	Hydraulic Conductivity
TH2 1.2 m – 2.4 m	CI – medium plastic silt	
TH4 0.2 m – 0.7 m	CH – high plastic clay and silt	
TH5 0.4 m – 2.0 m	CH – high plastic clay	1.87×10^{-8} cm/sec (in situ)
TH5 3.2 m – 6.0 m	CH – high plastic clay	
TH12 0.3 m – 0.8 m	CH – high plastic clay and silt	1.83×10^{-9} cm/sec (reworked)

The laboratory indicated that soils with the following characteristics would provide a liner with a hydraulic conductivity of 1×10^{-7} cm/sec or less:

- Liquid limit of 30% or greater;
- Plastic index of 10% or greater;
- 30% or more passing a number 200 mesh sieve ;
- 20% or more of clay particles.

The soil samples submitted had a liquid limit ranging from 41% - 97%; a plastic index ranging from 15% - 52%; and a clay content ranging from 33.8% - 78.2%. Therefore, based on the above results all of the soil samples submitted would meet the above criteria and would be expected to achieve a hydraulic conductivity of 1×10^{-7} cm/sec or less.

2.5.5.3 Topography

A topographical survey of the existing site features and the proposed expansion and borrow areas was completed using GPS survey equipment. Based on site observations, the native ground (i.e. not altered by site activities) was relatively flat, with no consistent slope in any direction. A maximum elevation difference of approximately 0.8 m, was recorded across the expansion and borrow areas.

The top of the active waste disposal cell dike was approximately 4.0 m above the cell floor. The top of the soap stock cell dikes was approximately 3.0 m above the cell floor, as measured where the cell floor was exposed. The ditching throughout the WDG site was approximately 1.0 m below the native surface grade, and flows to the south towards Road 10 NW.

2.5.6 Groundwater Elevation and Flow Direction

The groundwater elevation was calculated based on the measured depth to groundwater and the ground elevation at each monitoring well. The depth to groundwater (measured from the ground surface at the well) in each monitoring well was measured and recorded by lowering a weighted measuring tape down the well. The ground elevation was determined utilizing GPS survey equipment. A summary of the groundwater elevations and depth to groundwater in the monitoring wells is provided in Table A below.

Table A: Groundwater Elevations and Depths in Monitoring Wells at the Altona WDG

Well	Date	Ground Elevation (m asl)	Depth to Groundwater (m)	Groundwater Elevation (m asl)
MW1	28/8/15	241.93	2.26	239.67
MW2	28/8/15	241.58	2.21	239.37
MW3	28/8/15	241.87	2.20	239.67

From the groundwater elevation data obtained at the site, groundwater flow was determined to be toward the east and southeast direction; based on the assumption that groundwater is flowing from areas of higher elevation to areas of lower elevation. There was no vertical gradient measured between MW1 and MW3, which is an indication that flow is negligible between the west side of the WDG and the northeast side of the WDG. There would be flow from MW1 and MW3 towards MW2. It is not unusual for groundwater levels to fluctuate seasonally or annually, based on variable precipitation levels, therefore it is advisable to measure water levels at each sampling event to determine whether groundwater flow direction is consistent.

2.5.7 Groundwater Quality

During the site investigation, three monitoring wells were installed and baseline sampling of water quality parameters occurred. The WDG site has been operational and receiving waste since the early 1970s, therefore it is uncertain whether the baseline groundwater conditions were impacted from previous site activities.

The results of the laboratory analysis are summarized in Table B, along with a comparison to the Health Canada *Guidelines for Canadian Drinking Water Quality (GCDWQ)*, and *Manitoba Water Quality Standards, Objectives, and Guidelines*. The ALS laboratory analysis report is attached in the Appendix.

Table B: Groundwater Analysis Results

Parameter Measured	Units	MW1	MW2	MW3	Drinking Water Guidelines	
					MAC	AO
Alkalinity as Bicarbonate (HCO ₃)	mg/L	440	885	1950	NG	
Alkalinity Total as CaCO ₃	mg/L	360	726	1590	NG	
Alkalinity as Carbonate (CO ₃)	mg/L	<0.60	<0.60	<0.60	NG	
Alkalinity as Hydroxide (OH)	mg/L	<0.34	<0.34	<0.34	NG	
Ammonia as NH ₃ -N	mg/L	0.087	0.363	0.163	NG	
Arsenic – total	mg/L	0.0613	0.0335	0.0465	0.010	
Biochemical Oxygen Demand	mg/L	2.6	6.9	30.2	NG	
Benzene	mg/L	<0.0005	<0.0005	0.00244	0.005	
Cadmium – dissolved	mg/L	0.00017	<0.00016	0.00171	0.005	
Calcium – dissolved	mg/L	508	621	633	NG	
Chemical Oxygen Demand	mg/L	167	279	731	NG	
Chloride	mg/L	71	705	531		≤250
Chromium – dissolved	mg/L	<0.001	<0.001	0.003	0.05	
Conductivity	µmhos/cm	3780	>12900	7810	NG	
Copper – dissolved	mg/L	0.0031	0.0134	0.0353		≤1.0
Ethylbenzene	mg/L	<0.0005	<0.0005	<0.0005	0.14	≤0.0016
Hardness	mg/L	2510	7910	3320	NG	

Parameter Measured	Units	MW1	MW2	MW3	Drinking Water Guidelines	
					MAC	AO
Iron – dissolved	mg/L	<0.10	0.16	2.51		≤0.3
Lead – dissolved	mg/L	0.00012	<0.00015	<0.005	0.01	
Magnesium – dissolved	mg/L	301	1550	423	NG	
Manganese – dissolved	mg/L	0.02	0.091	10.5		≤0.05
Mercury – dissolved	mg/L	<0.00002	<0.00002	0.00003	0.001	
Nitrate – Nitrite - N	mg/L	<1.1	<1.1	<1.1	10	
Total Kjeldahl Nitrogen	mg/L	2.46	5.60	1.20	10	
pH	pH units	7.87	7.96	7.00		6.5 - 8.5
Phosphorus - total	mg/L	4.18	4.38	1.42	NG	
Potassium – dissolved	mg/L	7.58	27.9	9.76	NG	
Sodium – dissolved	mg/L	148	2290	1070		≤200
Total Dissolved Solids	mg/L	3890	12900	6980		≤500
Sulfate	mg/L	2350	10800	3260		≤500
Toluene	mg/L	<0.001	<0.001	<0.001	0.06	≤0.024
Xylene – total	mg/L	<0.0015	<0.0015	<0.0015	0.09	≤0.02
Zinc – dissolved	mg/L	0.0044	0.0076	0.0233		≤5.0

Notes for Table 2

MAC - Maximum Acceptable Concentration

AO - Aesthetic Objective

NG - No Guideline Criteria Established

* - Recommended limit for treatment/distribution systems

Bolded and highlighted values indicate values exceeding the Canadian Drinking Water Guideline limits

Guidelines for Canadian Drinking Water Quality, Health Canada, 2012, and the Tier III Water Quality Objectives, Manitoba Conservation, 2011.

The results of the laboratory analysis for the three monitoring wells revealed that the following parameters exceeded the Manitoba Conservation Tier III Water Quality Objectives and Health Canada Guidelines for Canadian Drinking Water Quality:

Table C: Exceedances of Water Quality Guidelines and Objectives

Well Identification	Exceedance of Guideline Parameters	
	Aesthetic Objective	Maximum Allowable Concentration
MW1 (up gradient)	Total Dissolved Solids	Arsenic

Well Identification	Exceedance of Guideline Parameters	
	Aesthetic Objective	Maximum Allowable Concentration
MW2 (down gradient)	Chloride Manganese Sodium Total Dissolved Solids Sulfate	Arsenic
MW3 (up gradient)	Chloride Iron Manganese Sodium Total Dissolved Solids Sulfate	Arsenic

The concentrations of arsenic are of greatest concern for health and safety as arsenic is considered a carcinogen and can have other vascular and neurological effects on humans. It is difficult to determine whether the past waste disposal activities are attributable to these concentrations in the monitoring wells, as high arsenic levels in groundwater can occur from naturally occurring weathering of soils. Without any baseline groundwater data from prior to waste disposal activities on the site, the cause can be difficult to determine, however concentrations of arsenic should continue to be monitored in the future to determine whether these levels are increasing or decreasing over time.

The following parameters were noticeably higher in the down gradient monitoring well (MW2):

- Ammonia
- Chloride
- Conductivity
- Hardness
- Magnesium
- Total Kjeldahl Nitrogen
- Potassium
- Sodium
- Total Dissolved Solids
- Sulfate.

The above parameters could be indicators of leachate contamination movement, however they could also be the result of soil conditions or localized surface contamination. Future groundwater testing would be required to determine if the above trends continue and whether water quality is degrading or improving over time.

2.5.8 WDG Cell Liner Requirements

The *Manitoba Siting Guidelines for Class I WDG Sites* require a clay liner of a waste disposal cell to have a minimum thickness of 1.0 m and have a hydraulic conductivity of 1×10^{-7} cm/sec or less. If suitable soils are not available for this construction, then a synthetic geomembrane liner can also be utilized. This low level of permeability in the active cell liner is required to ensure that leachate or wastewater does not impact surrounding groundwater resources.

Based on the *Draft Manitoba Compost Facility Guidelines* and from discussions with Manitoba Conservation, a liner 0.5 m thick, with a permeability of 1×10^{-7} cm/sec would be required below the composting storage pad. This liner could be obtained from in situ high plastic clay soil material directly below the topsoil layer.

In addition, the *Manitoba Siting Guidelines for Class I WDG Sites* describe the geological sensitivity of a site as being very high, high, moderate or low, based on the estimated vertical time of travel for liquid contaminants through the sub soils. Sites with a very high sensitivity would have an estimated time of travel of weeks to months until the contaminants reach the aquifer, while a site with a low sensitivity would have an estimated time of travel of several decades to a century before the contaminants would reach the aquifer. This not only considers the permeability of the soils below the active area, but also the depth of the overburden soils prior to reaching the aquifer of concern. Constructing a liner for the expansion cells, compost pad and retention pond, reduces the geological sensitivity of the site as it reduces the time of contaminant travel.

2.5.9 Contaminant Migration

The potential impact of leachate from the WDG on the underlying groundwater aquifer was evaluated to determine the geological sensitivity rating for the site. The following assumptions were made:

- leachate movement by advection
- no natural attenuation of leachate
- a hydraulic conductivity value of 1.87×10^{-8} cm/sec for the clay cell liner material was estimated from the insitu hydraulic conductivity value obtained at the site
- a vertical gradient of 0.86 down towards MW2, calculated by the hydraulic head and well depth in MW1 and MW2, based on measurements taken during the site investigation
- an average effective porosity of 0.385 was based on estimated values for the clay material.

The vertical rate of contaminant migration was calculated using Darcy's Law where:

$$q = \frac{Ki}{n_e}$$

Where: q = average linear velocity of the contaminant

K = average hydraulic conductivity of the soil
i = average hydraulic gradient
ne = average effective porosity of the soil.

Using the above parameters the average downward velocity of the contaminant is calculated as:

$$q = \frac{(1.87 \times 10^{-8})(0.86)}{(0.385)} = 4.1 \times 10^{-8} \frac{cm}{sec} = 0.013 \text{ m/year}$$

Based on the results of the calculated downward velocity of leachate, it would take approximately 692 years for contaminants to reach the observed bottom of the high plastic clay material observed on the site (9 m below the bottom of the expansion cell). Based on regional hydrogeological information, it would likely take much longer to reach any significant freshwater aquifer (30 m to 40 m) below the surface [i.e. Winkler Aquifer]. This would correspond to a geological sensitivity rating of low, defined by *Manitoba Siting Guidelines* as “water moving vertically will reach the aquifer within several decades to a century”. It would take less time for any potential contaminants to reach the shallow groundwater in the surficial sand layers, however these would be contained on the WDG site by the surrounding cut off wall.

2.5.10 Conceptual Design

2.5.10.1 Proposed Development

The proposed development is for the construction of expansion waste disposal cells, a compost pad and a leachate evaporation pond within the boundaries of the existing WDG. A vertical cut-off wall would be constructed surrounding the proposed and existing cells for containment of leachate. The compost pad will be located south of the expansion cells, outside of the proposed perimeter cut-off wall.

From a review of the projected waste generation, the initial expansion cell constructed should have capacity for a minimum of ten years of operation. The remaining expansion cells would have sufficient capacity for the remaining 25 year design life, however any changes in waste generation, waste diversion and population growth can impact this design life. The expansion cells and leachate pond would be located on the west side of the WDG site, while borrow soils would be obtained from the southeast portion of the WDG property.

The internal site access road would be extended into the expansion area to allow vehicle access to the expansion cells for waste drop off. The proposed expansion cells and access road would require perimeter ditching to connect with the existing ditching at the WDG site. The raised dikes around the expansion cells and leachate pond would prevent surface drainage from entering these areas. The expansion cells would be constructed with a floor sloped towards a buried leachate collection pipe, which would flow by gravity into a lift station, which would pump accumulated leachate to the leachate evaporation pond. The proposed site layout with expansion cells and leachate pond is shown in Plan 3 of Appendix D.

The compost area would utilize an existing approach off of Road 10 NW, which is separate from the WDG entrance gate. The topsoil in the compost area would be removed and utilized to construct a berm surrounding the compost pad. Geotextile and granular material would be placed on the clay base to form the working surface of the compost pad, to prevent liner destruction during mechanical turning of the compost material. The base of the compost pad would be sloped to the southwest, to ensure positive drainage into the perimeter ditching.

Conditions of the Environment Act Licence would be met through the expansion works along with the site operations. Site operations would remain relatively the same as existing, with regular compaction and covering of residential waste material in the waste disposal cells, and liquid levels in the leachate pond would need to be monitored regularly to ensure liquid level does not exceed the pond design.

Soap Stock Cells

From a review of the existing soap stock cells on the site, it is proposed that these cells would be converted to waste disposal cells or potentially another leachate evaporation pond in the future (beyond design year 25), after stabilization of the soap stock residue and capping is completed. It is assumed that one of these cells would be utilized as a burn cell in the future, to replace the existing burn cell once the initial expansion cell has reached capacity, in approximately ten years. The soap stock cell to be utilized for burning would need to be stabilized and capped with soil to ensure that the soap stock residue does not ignite and create a safety hazard once burning is conducted.

Based on test hole data completed by AMEC Foster Wheeler in May 2015, the dikes contain layers of medium to low plastic silt which may not meet permeability requirements of Manitoba Conservation. Permeability testing was not completed at the time of soil testing. The dikes would need to have permeability testing completed to determine whether they can be used for future waste disposal cells or a leachate pond in their current condition, or whether a containment liner would be required.

2.5.10.2 Storage Requirements

Based upon the projected waste generation rates for the site over 25 years, the expansion area within the WDG site boundaries and the existing and decommissioned waste disposal areas would be utilized for waste disposal to design year 25. The existing soap stock cells could be utilized for future waste disposal cells beyond this design year 25. The expansion area to the south of the existing waste disposal cells would also be utilized for construction of a leachate evaporation pond.

The initial expansion cell would be constructed so that solid waste would be disposed of both below and above grade, minimizing the total surface area required for the cell.

The cell sizing for the initial expansion cell is based on an excavation of 3.0 m below the surface and the waste being extended to a height of approximately 6.0 m above the existing ground surface. The below grade side slopes were assumed to be 3H:1V, while the above grade portion of the cell would have side slopes of 5H:1V. This initial expansion cell is estimated to have a life span of approximately 10 years.

For sizing of additional expansion cells [i.e. from design year 10 to 25] the area east of the initial expansion cell, currently containing active and covered cells, would be utilized. In this additional area it is assumed that all waste disposal will occur above the existing surface grade, with a perimeter berm constructed around the waste disposal area for containment. This area was considered for additional waste disposal storage to better utilize the footprint of the existing WDG, by continuing to deposit waste vertically, rather than expanding the site footprint. Based on the size of this existing waste disposal area, it is estimated that solid waste will extend approximately 2.4 m above the existing grade.

The expansion cells were also sized to include an additional volume of 20% for intermediate soil cover material. Additional volume would be obtained from arranging the expansion cells adjacent to each other and placing waste on the intercell dikes between the cells. Based on the available land area for expansion cell construction, the site would have a minimum storage capacity to design year 25.

The compost area would be sized in accordance with the requirements of the Municipality, to meet the needs of the service population.

2.5.10.3 Conceptual Liner Design

Based on the results of the onsite investigation and laboratory analysis, the layers of high and medium plastic clay and silt soil found throughout the expansion, compost and borrow areas would be suitable for use as a waste disposal cell, compost pad and leachate pond liner, both in situ and when reworked and compacted. There is however, also a surficial layer of unsuitable sand and silt throughout the site, which should not be incorporated in the liner design. Therefore, it is proposed that a vertical cut-off wall of reworked high plastic clay be constructed around the perimeter of the proposed expansion area and existing waste disposal area, which would tie into the in situ high plastic clay observed below the sand and silt layer. The in situ high plastic clay soils found at the site would be utilized as the horizontal liner, and the excavated high and medium plastic clay and silt soils observed would be utilized as the vertical cut-off wall, containing any leachate produced within the WDG site boundaries.

The proposed dikes of the expansion cells and leachate pond would be constructed with excavated materials and may allow for leachate attenuation, however as discussed above, any leachate produced would be contained within the WDG site by the perimeter cut-off wall.

The compost pad will be constructed with a horizontal base of in situ high plastic clay, with a minimum thickness of 0.5 m, and a permeability of 1×10^{-7} cm/sec or less.

Based on the results of the soils testing, materials utilized in the horizontal and vertical liner are expected to obtain a hydraulic conductivity of 1×10^{-7} cm/sec or less, with a minimum thickness of 1.0 m.

2.5.10.4 Cover System

The active portion of the expansion waste disposal cells are proposed to have a compacted layer of clean soil cover material (0.15 m thick) applied weekly. In expansion cells, it was assumed that the cover material will comprise approximately 20% of the total cell volume. Additional soil material excavated from the cell construction would be stockpiled and utilized as soil cover material in future site operations.

2.5.10.5 Leachate Management System

As a requirement of *Manitoba Regulation 150/91*, and the *Waste Management Facilities Regulation*, leachate produced at a WDG needs to be contained within the boundaries of the WDG and should not contaminate groundwater. Leachate has a potential to be produced when decomposing waste material comes in contact with water, and occurs most frequently in an active residential waste disposal cell, hazardous materials cell or a compost area.

The expansion waste disposal cells would be constructed with dedicated leachate collection and storage on the WDG site. The floor of the waste disposal cells would be graded towards a buried, corrugated leachate collection pipe, which will direct leachate produced into a manhole (see Plan 3 and 4 in Appendix D). From this manhole, leachate will be pumped into the leachate evaporation pond when necessary. This leachate management system shall also be utilized to collect and remove leachate generated from future waste disposal expansion cells (beyond design year 25).

To control leachate production, operation of the expansion waste disposal cells would consist of dividing the cells into thirds. At any given time, 1/3 of an active cell will be in use (i.e. accepting waste materials) and 2/3 will not be in use (i.e. empty or capped with a clay cover). The operator will divide the cells by building a temporary berm that will divert clean run-off water away from the in-use portion of the cell to minimize leachate production. This temporary berm would be approximately 0.3 m high and prevent surface water from entering the active portion of the waste disposal cell. Any rainwater collected in the non-active portion of the cell would be pumped out as required to the perimeter ditch by the site operator. Once the active portion of the cell is filled with solid waste up to the level of the berm, the soil from the berm can be

used as cover material and a new berm constructed at 2/3 the length of the cell. These stages of operation can be seen in Plan 6 of Appendix D.

The leachate evaporation pond will be a one cell structure utilized to store and naturally evaporate leachate liquid produced. As described in Section 2.5.10.3 above, the entire expansion area will be constructed with a vertical cut-off wall extending down into the native horizontal liner. The new leachate pond would be constructed within the footprint of this WDG expansion site liner, therefore a separate liner for the leachate pond would not be required. The dikes and cell floor would be constructed with excavated and compacted clay soils, from the site excavation, however sand and gravel material will not be utilized in the pond construction, due to the potential for erosion. As the leachate pond will not be constructed with a liner on the cell floor or dikes, some liquid seepage may occur into the surrounding soils, however leachate will be contained within the WDG site by the perimeter vertical cut-off wall and horizontal liner.

It is anticipated that liquid in the leachate pond will evaporate over time and maintain a balanced liquid level, however liquid can build up in the pond depending on the amount of precipitation experienced in a given season or year. Manitoba Conservation typically does not approve of surface discharge of leachate, nor is the hauling of leachate to a wastewater treatment lagoon typically permitted, due to the unknown chemical nature of the leachate. If liquid in the pond builds up to the point of overflowing, due to excess precipitation, an emergency discharge plan would need to be discussed with Manitoba Conservation.

The leachate pond was sized according to 1/3 the surface area of the initial expansion cell and the surface area of the leachate pond, along with the expected annual precipitation and evaporation over those areas. Therefore, the pond would have sufficient storage for precipitation falling on the active portion of the waste disposal cell and the leachate pond itself for a one year period, with additional storage capacity for years with excessive precipitation.

A landfill water balance was utilized to estimate the volume of liquid percolating through the solid waste and reaching the leachate collection system. This water balance utilizes average precipitation and evapotranspiration data provided by Environment Canada for Emerson, Manitoba over the past 4 years. The average annual precipitation recorded was 0.510 m/year and the average annual evapotranspiration recorded was 0.838 m/year, leading to an overall moisture deficit (net evaporation) of 0.328 m/year. The leachate pond would be sized to store one year of precipitation, assuming that the accumulation of liquid will evaporate over the same year. The annual volume of leachate generated in the initial expansion cell was estimated to be 2,370 m³/year, which considers approximately 10% moisture absorption in the soil and waste.

Additional hydraulic loading would come from precipitation falling directly on the leachate pond. Based on the surface area of the leachate pond cell an additional hydraulic loading of approximately 3,000 m³/year was considered in the sizing of the leachate pond.

The leachate pond is estimated to have a hydraulic storage capacity of approximately 3,100 m³, with additional storage capacity in the freeboard to store precipitation falling directly on the leachate pond. Based on Environment Canada data, it is expected that the majority of liquid accumulated in the leachate pond will evaporate fully over time.

The leachate pond is proposed to have an operating depth of 0.5 m, a freeboard height of 1.0 m, an inner slope of 4H:1V. The leachate pond would be excavated approximately 0.5 m below grade, with outer dikes constructed to a minimum height of 1.0 m above grade. The dike tops would be constructed to a width of approximately 3.0 m, for ease of construction. Details of the dike construction are shown on Plan 4 in Appendix D.

2.5.10.6 Monitoring Wells

As the expansion cells will be surrounded with a reworked vertical liner and an in situ horizontal liner, it is expected that leachate will be contained within the site and will not contaminate groundwater beyond the site boundaries. However, Manitoba Conservation guidelines suggest a groundwater monitoring system comprised of a minimum of three monitoring wells (one up gradient and two down gradient of the WDG, on the basis of the assumed direction of the groundwater flow).

Three monitoring wells were installed around the perimeter of the WDG site, one on the west side, one in the northeast corner and one on the east side (see Plan 2 in Appendix D). The monitoring wells were installed below the proposed floor elevation of the expansion cells, with the screened section of the wells capturing the water bearing sand and silt layer observed throughout. The monitoring wells were also located outside of the proposed perimeter cut-off wall, therefore groundwater quality would only be impacted by contaminants leaching through the cut-off wall (if any) or surrounding land use activities (i.e. farming). The monitoring wells would be maintained at the site for continued sampling and monitoring of groundwater parameters.

2.5.10.7 Drainage

The proposed perimeter ditching throughout the expansion area would drain to the ditch along Road 10 NW. Based on survey data and a review of regional topographical mapping, it appears that the existing ditch along Road 10 NW flows east and north along Rempel Drain and other municipal drains for approximately 17 km, until reaching the Red River.

2.5.10.8 Access Road

The existing all-weather access road to the WDG site (Road 10 NW) is well maintained and will continue to be utilized for access to the site. From site observations, the interior roads accessing the compounds and waste disposal cells will need to be extended into the expansion area, utilizing compacted granular materials for construction. Access to each of the proposed expansion cells will be required with truck turnaround areas at proposed drop off locations. The proposed interior roads would have adequate width for two-way traffic and would be able to withstand heavy equipment traffic. The existing approach to the compost area would be upgraded with additional granular material. The proposed road base would consist of compacted subgrade, geotextile, C base granular material and A base granular material (see Plan 5 in Appendix D).

2.5.10.9 Fencing and Signage

The proposed expansion cells will include a perimeter fence to be placed around the perimeter of the dikes, to act as a waste catchment barrier and prevent unauthorized entry into the cell(s). This fence would consist of a 1.8 m high portable fence and would tie into the existing perimeter fencing (see Plan 6 in Appendix C), which can be moved as the dikes are raised or a new cell is constructed. A 1.8 m high fixed knot game fence will also be placed around the leachate pond top of dike to prevent large animals or unauthorized entry to the pond.

The sign indicating drop off location should be placed at the entrance to the expansion cell(s). Warning signs should also be posted around the perimeter of the leachate pond for health and safety purposes. The existing signage at the entrance to the WDG facility is adequate for future use, as it contains information regarding:

- site operating permit
- hours of operation
- waste material accepted
- waste material not accepted
- general site operating rules.

2.5.10.10 Compounds

The existing storage and recycling compounds, and burn cells, on the WDG site would likely need to be relocated after the initial 10 expansion cell has reached capacity. The area these compounds/cells currently occupy is to be utilized for continued waste disposal from design year 10 to 25. The compounds would likely be relocated to the east side of the WDG site, along the existing access road, while the burn cells would be relocated to an existing soap stock cell (see Plan 3 in Appendix D). Currently these compounds/cells include:

- two burn cells
- chemical container storage
- used tire storage
- scrap metal storage
- used oil eco-centre
- concrete and rubble storage.

The compounds would require suitable base pads (i.e. granular material), proper drainage and containment fencing. It is also assumed that the existing used oil eco-centre building will be relocated. If the burn cells are relocated to an existing soap stock cell, it would need to be constructed with the existing berms on three sides and catchment fencing on top of the berms, both of which are currently in place around these cells.

2.5.11 Construction Techniques

The reworked soils forming the vertical cut-off walls are to be constructed to a minimum width of 1.0 m, however to accommodate typical construction equipment and vehicle access requirements it is assumed that the cut-off wall will have a minimum width of 2.0 m at the base and 3.0 m on the top of dike. The below grade cut-off wall will require 1H:1V slopes from 1.0 m above the bottom of the liner to the surface for safety reasons during construction (see Plan 4 in Appendix D). The cut-off wall would extend to variable depths, depending on the depth of sand layer discovered at the site, however the cut-off wall would extend 1.0 m below the sand layer into the in situ horizontal liner. The cut-off wall would also extend approximately 1.0 m above the existing grade and would form the dikes of the expansion cells and leachate pond. For the purpose of sizing the site, the initial expansion cell floor elevation will have an average depth of approximately 3.0 m below the average surface elevation in the expansion area. Details of the dike and liner construction are shown on Plan 4 in Appendix D.

The clay and silt soils forming the cut-off wall would be obtained from excavation of the initial expansion cell, leachate pond and from a borrow area in the southeast corner of the property. Any sandy soils excavated would be stockpiled and utilized for cover material during site operations.

For dike and cut-off wall construction, the excavated material is to be compacted with to a minimum Standard Proctor Density of 98%, in lifts of 150 mm. The dike and liner material should be compacted with a minimum of eight passes of a sheepsfoot roller on each 150 mm lift. A limited range of moisture content will be permitted during construction. The material shall not be so wet nor so dry that compaction equipment cannot compact the fill into a homogeneous mass. Material too wet shall be dried or wasted and material too dry shall be wetted. The cell bottom will be graded to a tolerance of ± 50 mm. The inner and outer dikes would be constructed with a mixture of excavated soil material observed at the site (i.e. clay, silt, sand and topsoil).

The construction specifications should indicate that the sheepsfoot roller shall have a minimum foot pressure of no less than 1,700 kPa (250 psi). The drum diameter of the sheepsfoot roller should not be less than 1,200 mm. Each roller should be equipped with cleaning fingers designed to prevent the accumulation of material between the tamping feet. The foot pressure would be calculated by taking the total mass of the roller and dividing it by the greater of: the area of the maximum number of tamping feet in one row parallel to the axis of the roller, or by 5% of the total foot area. The roller feet should be at least 200 mm long and should have a minimum area of at least 4,500 mm².

2.5.12 Decommissioning and Closure

The waste disposal cells, when at maximum height above ground, will be decommissioned by covering with a minimum of 0.5 m compacted clay soil and topsoil as per *Manitoba Conservation Siting Guidelines* and Reg. 150/91. The surface of the capped cells will be graded to allow positive drainage away from the cell towards the perimeter ditching. The decommissioned cells will be seeded with grass to provide an aesthetically pleasing environment, and regular monitoring of the site will continue to occur to determine if there are any impacts to groundwater at the site. The existing monitoring wells should be sampled and tested on a regular basis for the baseline water chemistry parameters described in Section 2.5.8 above, or as prescribed by the Environment Act Licence.

The final contours of the finished cells are proposed to be such that they will have a maximum finished elevation of approximately 5.5 m above grade. The outside slopes of the capped cells should be a minimum of 5H:1V. The final contour of the cells will assist in minimizing infiltration of water, preventing surface water ponding and retaining slope stability. A top layer of organic soils seeded with grass will be placed to provide a vegetative cover that will further reduce the potential for erosion by wind or surface run-off, and reduce infiltration of precipitation through evapotranspiration. The existing waste disposal cell is below grade has approximately 2 more years of capacity prior to reaching the surrounding grade elevation, at which point this cell will be covered and a the initial expansion cell can be utilized. The initial expansion cell will have an estimated life span of 10 years. After this ten year period, the area previously utilized for waste disposal and covered can be utilized for continuing waste disposal above grade within the perimeter dike.

2.5.13 WDG Maintenance and Operation

The WDG site will have designated and trained operators from the Town of Altona and Municipality of Rhineland public works department to handle the following tasks:

- Collecting tipping fees at the gate entrance
- Recording waste tonnage dropped off at the site
- Directing the public to the appropriate drop off locations
- Moving, covering and compacting waste material in the active waste disposal cells

- Moving ash from the burn cells into the active cells after material is completely extinguished
- Inspecting and maintaining the fencing, gate and lock
- Ensuring the entrance gate is locked at all times when the operators are not present
- Ensuring burning activities are continuously monitored
- Ensuring the liquid level in the leachate manhole and pond are maintained at an acceptable height
- Monitoring the level of the used oil tank and ensuring that this waste material is hauled off of the site by a licenced hauler, when required
- Ensuring recyclable materials are hauled off site regularly and that compounds do not reach capacity
- Ensuring that unacceptable waste products are not dumped at the site
- Ensuring internal access roads are cleared and maintained regularly
- Ensure windblown waste material is cleaned up regularly
- Controlling insects, rodents and other vectors onsite.

For public safety, access to the active portion of the waste disposal cell should be restricted to the WDG operators only, with the public only having access to the designated drop off area located at the entrance to the cells. The groundwater at the WDG site should be tested periodically from the monitoring wells to determine whether contamination to groundwater is occurring from site activities.

2.5.14 Compost Operation and Maintenance

It is expected that compost waste material will be deposited by individual drop off at the designated receiving area of the WDG and by curbside pickup. The compost material will be placed into windrows or piles at the site and mechanically turned to assist in aeration and speed up the decomposition process. The compost will typically be turned mechanically with available equipment six to eight times before the final product is fully cured. Bulking agents will also be utilized such as wood chips, to assist with natural aeration. A minimal internal temperature of 55°C should be maintained in the windrows/piles throughout this period, to allow for sufficient decomposition and pathogen destruction. This phase of decomposition typically lasts four to five weeks, under ideal conditions.

Beyond mechanical aeration (turning), other factors such as moisture content, particle size, and the carbon to nitrogen ratio, contribute to successful decomposition of the organic material. In general, the more controlled these factors are the faster the composting process will take place. The compost is then permitted to sit and stabilize before being distributed to residents. Typically, the compost should age for approximately one year to be considered safe for distribution.

3.0 POTENTIAL ENVIRONMENTAL IMPACTS

The biophysical and socioeconomic environment as related to the development, and potential impacts of the development on the environment.

3.1 Releases to Air, Water, Land

3.1.1 Air

Prevailing winds in the area can carry odours if the waste disposal areas are exposed and wind breaks are not utilized around the site. These odours have the potential to be a nuisance to nearby residents.

While there is potential for odours at the WDG site during operation, the active waste disposal activities will be located a minimum distance of 400 m from the nearest rural resident. In addition, with weekly waste cover material being utilized, odours are not likely to become a nuisance. The site is also bordered by a partial tree line which acts as a windbreak to reduce the spread of odours. Due to the evaporation of liquid leachate, odours from the leachate pond are not expected to be significant.

There is also a potential for greenhouse gas emissions during construction and operation works from heavy equipment and transport vehicles. As heavy equipment is currently utilized daily from site operations, there would only be a minor increase during the construction works, with additional heavy equipment on site. Impacts from dust generation are not expected to be significant as the construction area will meet the minimal setback distances from residences, and a treed windbreak exists around portions of the WDG border and around the perimeter of the nearest resident, to reduce the likelihood of dust being considered a nuisance.

3.1.2 Water

Pollutants that have the potential to be released into surface water and groundwater during the operation of WDG would be from leachate production. Pollutants potentially produced in waste disposal cells would generally include nutrients, coliforms, volatile organics, suspended solids, heavy metals, inorganic compounds and organic carbons that are typical for leachate produced from residential and commercial wastes.

Pollutants that have a potential to be released into the surface water or groundwater during the WDG expansion construction activities, would include petroleum hydrocarbons (PHCs) from heavy equipment spills/leaks and sediments from soil erosion.

3.1.3 Land

The landscape would be altered by construction of expansion cells which will extend several metres above the surrounding grade. Perimeter dikes, ditching and fencing would also be constructed/installed around the perimeter of the expansion cells, if not already in place. Leachate and windblown litter can impact surrounding lands if not contained. Ground areas

disturbed by construction activities can be impacted through soil erosion if not covered or re-vegetated shortly after works are completed.

Pollutants that may be released to the land are predominantly PHCs, which could be released during construction activities from equipment leaks, and/or re-fuelling incidences and could result in impacts to the soils/land.

3.2 Wildlife

The WDG site is located in the “Lake Manitoba Plain” Ecoregion of Canada. Characteristic wildlife includes: white-tailed deer, beaver, coyote, rabbit, ground squirrel and waterfowl. Wildlife common at landfill sites include rodents, gulls and crows, however no wildlife was observed at the site during the site investigation.

The typical concern on any construction project is that wildlife species would be displaced through the construction works. However from observations made during the site investigation it is unlikely that the construction works will have any significant impact on wildlife or wildlife habitat in the area, as the expansion and borrow areas are cleared sections of land adjacent to active waste disposal cells and surrounding agricultural land. In addition, the expansion area is also bordered by an all weather municipal road, therefore human activity in the area is evident and this would typically detract wildlife from the area. The construction of a leachate storage pond could attract more waterfowl [i.e. geese and ducks] to the site.

In addition, the Manitoba Conservation Data Centre and Wildlife and Ecosystem Protection Branch were contacted regarding occurrences of rare or endangered wildlife and bird species in their database for the proposed expansion area. The response indicated there were no occurrences of rare species identified in the area of the proposed development, based on information in the provincial database (see email correspondence attached in Appendix B).

3.3 Fisheries

The typical concerns with impacts to fish and fish habitat are from sediments released during construction and the leachate discharges into a body of surface water utilized by fish species. These impacts could include the reduction of water quality or physical disturbances that would create an unfavorable environment for fish or fish eggs. As leachate will be contained on site and there are no bodies of surface water with fish species in the area of the WDG, impacts to fish species are unlikely.

Buffalo Creek is the nearest body of surface water with fish species, located approximately 2.5 km to the north, but surficial flow direction from the WDG site was estimated to be towards the east and north towards the Red River, located approximately 17 km away, with flows following municipal drains.

3.4 Vegetation and Forestry

Characteristic vegetation in the “Lake Manitoba Plain” Ecoregion is a mixture of farmland and aspen parkland. The native landscape is characterized by trembling aspen, oak groves and rough fescue

grasslands. During the site investigation, wild grasses, bulrushes, reeds and planted alfalfa were observed in the expansion area, while the tree line surrounding the site consisted of trembling aspen and oak.

The typical concern on any construction project is the removal of vegetative species through the construction works, however as the expansion area has been cleared of trees there will be a minimal loss of native vegetation. The majority of the vegetative species to be removed will be native grasses and planted agricultural crops from the expansion area. Manitoba Conservation Wildlife and Ecosystem Protection Branch was contacted regarding occurrences of rare or endangered vegetative species in their database for the proposed expansion area. The response indicated that there were no occurrences of rare species identified at the proposed development site (see email correspondence attached in Appendix B).

The area of the WDG expansion is a cleared parcel of land, therefore no potential impacts to forestry in the area are expected, as no tree removal will be required and the area is not commercially forested.

3.5 Noise Impacts

There is a potential for noise impacts in the immediate area of expansion due to the heavy equipment utilized during construction, however these impacts are not expected to be significant, as heavy equipment is already being used at the site during daily maintenance. No additional noise impacts are expected during operation of the expanded WDG as no additional maintenance equipment will be utilized.

3.6 Health and Safety

There is a potential for impacts to the health and safety of workers and the public during the construction works, as heavy equipment will be utilized on site while the public has access to other areas of the WDG.

3.7 Heritage Resources

The Town of Altona was not aware of any historic, traditional or heritage resources located at the proposed expansion site. The Manitoba Historic Resources Branch was contacted regarding the proposed site. The Manitoba Historic Resources Branch was contacted regarding previously recorded heritage sites in the area of development, however they did not respond. It is unlikely that any historic or heritage resources will be impacted, given the agricultural nature of the area.

While impacts to historic or heritage resources are not expected at the site, there is always potential for an unexpected discovery when excavating an area that has not recently been excavated.

3.8 Socio-Economic Implications

The WDG expansion is not expected to have adverse socio-economic impacts. In fact, construction related economic activity is likely to have a positive economic impact on the Town of Altona. In addition, the WDG site would have increased waste storage capacity for the service population upon completion of the project.

Traffic along Road 10 NW would increase minimally from heavy construction equipment travel to and from the WDG site during construction, however no impacts from traffic are expected during operation of the expanded site. There is also room on the site for parking construction equipment and transport vehicles, therefore traffic should not be impacted while onsite or while travelling to the site, due to parked equipment/vehicles.

3.9 Aesthetics

The WDG expansion will have an impact on the general aesthetics of the area, as the expansion cells would be extended several metres above the surrounding grade. The works would occur adjacent to Road 10 NW, however this is not a main through road in the area and the tree line around the perimeter of the site would be maintained to limit the visual impacts to residents in the area. Excavation works will eliminate the use of the expansion area for agriculture. Windblown litter is also a concern at WDG sites as it creates a site which can be aesthetically unpleasing.

4.0 MANAGEMENT PRACTICE

Proposed environmental management practices to be employed to prevent or mitigate adverse implications from the impacts identified above.

4.1 Mitigation of Impacts to Air

To reduce the potential for nuisance odour impacts, the expansion will be located beyond the minimum setback distances to nearby residents. Regular covering of the waste disposal cells will reduce the odours generated from the site.

Emissions from construction equipment and transport vehicles will be controlled through regular maintenance by the contractor, and should meet all provincial and local emission standards. Dust suppression methods (i.e. water spraying) can be utilized at the construction site if dry conditions create excessive dust through construction activities and transport, and becomes a nuisance to nearby residents.

4.2 Mitigation of Impacts to Water

Impacts to surrounding surface waters and groundwater from leachate production in the waste disposal cells will be reduced by the construction of a perimeter soil liner, which meets the permeability requirements of Manitoba Conservation. Leachate produced will be collected and contained in a leachate storage pond and will be dissipated through natural evaporation.

Siltation in the municipal road ditch from disturbed soil areas during the construction works will be mitigated through the installation of silt fencing. Dike and ditch slopes would also be seeded with grass to control erosion.

To minimize impacts from construction equipment leaks or spills, the construction contractor will be responsible for maintaining heavy equipment to prevent leaks and spills of fuels, lubricants, hydraulic fluids or coolants. In addition, the construction specifications should outline to the contractor the requirements for handling and storage of fuels and hazardous materials during construction, as per federal and provincial regulations. The construction specifications should state wording similar to the following:

- Diesel or gasoline should be stored in double walled tanks or have containment dikes around fuel containers for volumes greater than 68.2 L (15 gallons) or in compliance with provincial regulations
- Clean up material should be available at the site, consisting of a minimum of 25 kg of suitable commercial sorbent, 30 m² of 6 mm PVC, and an empty fuel barrel for spill collection and disposal
- Fuel storage and hazardous material areas established for project construction should be located a minimum of 100 m from a waterbody or drainage route
- There can be no re-fueling or servicing of construction equipment within 100 m of a water body or drainage route

- Waste hazardous materials from construction activities and equipment must be properly collected and disposed of in compliance with provincial regulations
- In the event of spills or leaks of fuels and hazardous materials, the contractor or operator should notify the project engineer and provincial authorities (Manitoba Conservation at (204) 944-4888).
- Hazardous material handling and storage are to follow all provincial and federal regulations including WHMIS and spill containment requirements.

4.3 Mitigation of Impacts to Land

To minimize impacts to the surrounding land, containment dikes and fencing around the expansion cells will act to contain leachate and windblown litter to the designated areas. Weekly cover will also act to prevent windblown litter and the production of leachate in the waste disposal cells. Disturbed ground surface areas will be seeded upon completion of construction works to minimize soil erosion. To minimize the potential for slope erosion, the outer dike slopes would be seeded with grass upon completion of construction. To minimize the potential for the release of PHCs into the soil, the mitigation measures described in Section 4.2 above, outlining equipment maintenance and fuel-handling procedures, should be followed.

4.4 Mitigation of Impacts to Vegetation

The removal of surface vegetation will be limited to the construction area by clearly marking the site boundaries prior to construction. Tree removal will not be required, as the expansion area is actively farmed. Vegetation outside of this construction area will not be damaged and the tree line surrounding the site will remain intact. Soil surfaces exposed during the construction works will be seeded with grass upon completion of construction.

4.5 Mitigation of Noise Impacts

To minimize the potential for noise impacts, construction equipment and transport vehicles should have mufflers working properly, and construction activities should be limited to daylight hours only.

4.6 Mitigation of Impacts to Health and Safety

To minimize impacts to health and safety of workers and the public, the construction contractor should have a safety program in place, in accordance with all federal and provincial health and safety regulations. During construction, access to the construction areas will be limited to the construction crew only. Personal protective equipment will be worn by all personnel while in the construction area, in accordance with the contractor's safety program.

Fencing will be placed around the waste disposal cells and leachate pond to prevent unauthorized entry by humans or large animals. Access to the leachate pond and the active face of the waste disposal cells will be limited to WDG operators.

4.7 Mitigation of Impacts to Heritage Resources

If any significant historic or heritage resources are discovered in the course of excavation or construction, the works would temporarily cease and an investigation of the site is to be conducted by the Town Altona, Municipality of Rhineland, Manitoba Historic Resources Branch and any other provincial or federal authority as may be required.

4.8 Aesthetics

Impacts to aesthetics at the WDG site would be mitigated by maintain the tree line along the east border of the site to reduce the visual impacts of future waste disposal cells. Areas with disturbed soils would be seeded with grass upon completion of construction. Windblown litter would be reduced by weekly cover in the waste disposal cells and would be cleaned up regularly as part of the WDG operations, which would increase aesthetics of the site.

5.0 RESIDUAL AND CUMULATIVE EFFECTS

Residual environmental effects remaining after the application of mitigation measures, to the extent possible expressed in quantitative terms relative to baseline conditions

No negative residual effects are anticipated through the WDG expansion construction and operation, due to the mitigation measures described above. Positive residual effects to the service area are expected from the increased waste disposal capacity, which will allow for continued growth of the service population without immediate concern for waste disposal availability. In addition, the construction of a containment liner around the existing and proposed waste disposal cells, would minimize the potential for contaminants leaving the WDG site.

Cumulative effects from other construction projects in the area may occur if the Altona lagoon expansion project overlaps with this WDG project. The two sites are located approximately 3.4 km apart. There is a potential that these combined projects would create cumulative impacts from heavy traffic along PTH 30 and PR 201, which are the main access route for both sites.

6.0 MONITORING AND FOLLOW-UP

Proposed follow-up activities that will be required at any stage of development (eg. Monitoring, inspection, surveillance, audit, etc.)

The perimeter liner around the WDG expansion cells and leachate pond would be inspected and tested in the presence of Manitoba Conservation, upon completion of construction works and prior to commissioning. The liner would be tested for hydraulic conductivity to ensure that the requirements of the Environment Act Licence are met.

Long-term monitoring on the WDG site would include regular testing of the groundwater monitoring wells for water quality parameters described in the Environment Act Licence. The operator is also to ensure that the liquid level in the leachate pond is maintained at an acceptable height and does not overflow the cell dikes. The operator is also to maintain records of type and quantity of waste received at the site. If there are any concerns with the operation of the WDG or with possible groundwater contamination, the Town of Altona is to contact the local environment officer and the Environmental Approvals Branch of Manitoba Conservation to discuss options. The construction contractor is to ensure that grass growth occurs on slopes and disturbed areas, after the construction activities are completed.

7.0 FUNDING AND APPROVALS

Name and address of any Government Agency or program (federal, provincial or otherwise) from which a grant or loan of capital funds have been requested (where applicable). Other federal, provincial or municipal approvals, licences, permits, authorizations, etc. known to be required for the proposed development, and the status of the project's application or approval.

Funding for this project would be provided by the Town of Altona and the RM of Rhineland. During the construction works, Manitoba Hydro and MTS will need to be contacted to notify of the proposed works and to locate any buried utility lines. No additional approvals, licences or permits, beyond the Environment Act Licence, are expected for the WDG expansion construction and operation.

8.0 PUBLIC CONSULTATION

Results of any public consultations undertaken or to be undertaken in conjunction with project planning.

Public consultation by the Town of Altona through a designated public forum, has not been conducted to date for the residents in the town or municipality, as funding for the project has not yet been established. Public comments received by Manitoba Conservation through the public registry during the Environmental Act Proposal review period will be addressed prior to the WDG expansion works.

9.0 CONCLUSION

Based on the design of the project and the implementation of the mitigation measures identified in Section 4.0 above, no significant negative environmental impacts are anticipated.

The proponent would like to complete the requirements of the Environment Act Proposal as soon as possible so that the WDG expansion construction works can begin in a timely manner.

JR Cousin Consultants Ltd. requests that a draft copy of the Environment Act Licence be forwarded for review prior to the issue of the final licence.

APPENDIX

Appendix A

Status of Title

Crown Lands & Property Agency - Lands Branch, November 16, 2015 Email Correspondence

Appendix B

Table 1: Population and Waste Generation Projections – Altona Waste Disposal Ground

Manitoba Conservation and Water Stewardship - Wildlife and Ecosystem Protection Branch, September 9, 2015
Email Correspondence

Appendix C

Test Hole Logs

AMEC Foster Wheeler Soils Analysis Report, October 28, 2015

AMEC Foster Wheeler Soils Analysis Report, December 11, 2015

ALS Test Results, August 31, 2015

Appendix D

Title Page

Plan 1: Site Location Plan with Required Setbacks

Plan 2: Waste Disposal Ground Expansion Site with Test hole Location Plan

Plan 3: Proposed Waste Disposal Ground Expansion Layout and Drainage Plan

Plan 4: Dike, Liner, Leachate Pipe and Manhole Details

Plan 5: Road, Ditch, Fence, Silt Fence, Compost Pad and Sign Details

Plan 6: Site Operations Plan

Appendix A

Status of Title

Crown Lands & Property Agency - Lands Branch, November 16, 2015 Email Correspondence

Status of Title

STATUS OF TITLE

Title Number **2581984/4**
Title Status **Accepted**
Client File **Lorelie Diaz**

The Property Registry

A Service Provider for the Province of Manitoba



1. REGISTERED OWNERS, TENANCY AND LAND DESCRIPTION

TOWN OF ALTONA AND RURAL MUNICIPALITY OF RHINELAND

ARE EACH REGISTERED OWNER OF AN UNDIVIDED ONE-HALF INTEREST SUBJECT TO SUCH ENTRIES RECORDED HEREON IN THE FOLLOWING DESCRIBED LAND:

PARCEL I:

ALL THAT PORTION OF SE 1/4 27-2-1 WPM TAKEN FOR STOCK PILE
SITE PLAN 1343 MLTO
INCLUDING ALL MINES, MINERALS AND OTHER MATTERS AS SET OUT
IN THE CROWN LANDS ACT AND IN TRANSFER 1168296/4 MLTO

PARCEL II:

LOT 2 SP PLAN 2137 MLTO
IN SE 1/4 27-2-1 WPM

The land in this title is, unless the contrary is expressly declared, deemed to be subject to the reservations and restrictions set out in section 58 of *The Real Property Act*.

2. ACTIVE INSTRUMENTS

No active instruments

3. ADDRESSES FOR SERVICE

TOWN OF ALTONA
BOX 1630
ALTONA MB
ROG 0B0

R. M. OF RHINELAND
BOX 1630
ALTONA MB
ROG 0B0

4. TITLE NOTES

No title notes

5. LAND TITLES DISTRICT

Morden

6. DUPLICATE TITLE INFORMATION
Duplicate not produced
7. FROM TITLE NUMBERS
1917232/4 All
2068425/4 All
2068428/4 All
8. REAL PROPERTY APPLICATION / CROWN GRANT NUMBERS
No real property application or grant information
9. ORIGINATING INSTRUMENTS
Instrument Type: Transfer Of Land
Registration Number: 1168296/4
Registration Date: 2012-03-02
From/By: PROVINCE OF MANITOBA
To: TOWN OF ALTONA AND RURAL MUNICIPALITY OF RHINELAND
Consideration: \$12,500.00
10. LAND INDEX
Plan 1343
STOCK PILE SITE IN SE 27-2-1W
Lot 2 Plan 2137
IN SE 27-2-1W
SE 27-2-1W
STOCK PILE SITE PLAN 1343 MLTO

CERTIFIED TRUE EXTRACT PRODUCED FROM THE LAND TITLES DATA STORAGE SYSTEM OF TITLE NUMBER 2581984/4

Crown Lands & Property Agency - Lands Branch, November 16, 2015 Email Correspondence

Oswald Wohlgemut

From: Little, Karen (CLPA) [Karen.Little@gov.mb.ca]
Sent: Monday, November 16, 2015 1:10 PM
To: 'Oswald Wohlgemut'
Subject: RE: Altona Waste Disposal Ground - Mines and Mineral Rights

Good afternoon Oswald – according to The Crown Land Registry this date:

The Dominion of Canada granted SE 27-2-1 WPM to John R Scott in July 1885 along with the mines & minerals and sand & gravel. The Crown kept no ownership of the under-rights.

- Current Certificate of Title 2581984/4 - Parcel 1: includes all mines, minerals and other matters as set out in *The Crown Lands Act* and in Transfer 1168296/4 MLTO. Ownership of the mines & minerals and sand & gravel remains with this surface title.

Parcel 2: is silent as to the exceptions and therefore reverts to how the land was originally granted. Therefore ownership of the mines & minerals and sand & gravel remains with this surface title.

Sincerely,

Karen Little
Supervisor of Crown Lands Registry

Crown Lands and Property Agency
308 - 25 Tupper Street North
Portage la Prairie MB R1N 3K1
P 204-239-3805 F 204-239-3560
Toll Free 1-866-210-9589
karen.little@gov.mb.ca



An Agency of the Manitoba Government

The information contained in this e-mail and all attachments is confidential and is for the sole use of its intended recipient. It may not be disclosed to or used by anyone other than the addressee. If received in error, please contact the sender by return e-mail and delete this e-mail and all attachments from your system.

Le présent courrier électronique (courriel) et les documents qui y sont attachés peuvent contenir de l'information confidentielle; ils s'adressent exclusivement au destinataire mentionné ci-dessus et nulle autre personne ne doit en prendre connaissance ni les utiliser ou les divulguer. Si vous recevez le présent courriel par erreur, veuillez en aviser l'émetteur immédiatement par courrier électronique et le détruire avec les documents qui y sont attachés.

From: Oswald Wohlgemut [<mailto:owohlgemut@jrcc.ca>]
Sent: November-13-15 3:01 PM
To: Little, Karen (CLPA)
Subject: Altona Waste Disposal Ground - Mines and Mineral Rights

Hello Karen,

JR Cousin Consultants Ltd. is submitting an Environmental Act Proposal on behalf of the RM of Rhineland for the expansion of the Altona waste disposal ground near the Town of Altona, MB in SE 27-2-1 WPM. We have attached a copy of the title status provided by the property registry for the parcels of land proposed in the development. Could you confirm the ownership of the mineral rights for both parcel 1 and parcel 2?

Let me know if you have any questions.

Appendix B

Table 1: Population and Waste Generation Projections – Altona Waste Disposal Ground

Manitoba Conservation and Water Stewardship - Wildlife and Ecosystem Protection Branch, September 9, 2015
Email Correspondence

Table 1: Population and Waste Generation Projections – Altona Waste Disposal Ground

**TABLE 1
POPULATION AND WASTE GENERATION PROJECTIONS
Altona Waste Disposal Ground**

Column 1	Column 2	Column 3	Column 4	Column 5	Column 6	Column 7	Column 8	Column 9	Column 10
CALENDAR YEAR	PROJECT YEAR	RM OF RHINELAND RURAL POPULATION	TOWN OF ALTONA POPULATION	TOWN OF GRETNA POPULATION	LUD OF ROSENFELD POPULATION	TOTAL WASTE GENERATION (RM of Rhineland Rural)	TOTAL WASTE GENERATION (Altona, Gretna, Rosenfeld)	TOTAL WASTE FOR DISPOSAL (Residential and Rural)	TOTAL WASTE TO DISPOSAL SITE
		(people) 0.3% Growth	(people) 1.6% Growth	(people) 0.2% Growth	(people) 0.5% Growth	0.94 kg/person/day (tonnes / year)	1.24 kg/person/day (tonnes / year)	(tonnes / year)	(m3 / year)
2011	0	4,025	4,088	556	348	1374	2252	3,626	7,634
2012	0	4,038	4,151	557	350	1378	2282	3,686	7,760
2013	0	4,051	4,216	558	351	1382	2312	3,355	7,063
2014	0	4,064	4,281	560	353	1387	2343	3,780	7,958
2015	0	4,077	4,347	561	355	1391	2374	3,766	7,928
2016	1	4,090	4,415	562	357	1396	2406	3,802	8,004
2017	2	4,103	4,483	563	359	1400	2438	3,839	8,081
2018	3	4,116	4,553	565	360	1405	2471	3,876	8,160
2019	4	4,129	4,623	566	362	1409	2504	3,914	8,239
2020	5	4,142	4,695	567	364	1414	2538	3,952	8,320
2021	6	4,156	4,768	568	366	1418	2572	3,991	8,401
2022	7	4,169	4,842	570	368	1423	2607	4,030	8,484
2023	8	4,182	4,917	571	369	1427	2642	4,070	8,568
2024	9	4,196	4,993	572	371	1432	2678	4,110	8,653
2025	10	4,209	5,070	573	373	1436	2714	4,151	8,739
2026	11	4,223	5,149	575	375	1441	2751	4,192	8,826
2027	12	4,236	5,229	576	377	1446	2789	4,234	8,914
2028	13	4,250	5,310	577	379	1450	2827	4,277	9,004
2029	14	4,263	5,392	578	381	1455	2865	4,320	9,095
2030	15	4,277	5,476	580	383	1460	2904	4,364	9,187
2031	16	4,291	5,560	581	385	1464	2944	4,408	9,281
2032	17	4,304	5,647	582	386	1469	2984	4,453	9,376
2033	18	4,318	5,734	584	388	1474	3025	4,499	9,472
2034	19	4,332	5,823	585	390	1478	3067	4,545	9,569
2035	20	4,346	5,913	586	392	1483	3109	4,592	9,668
2036	21	4,360	6,005	587	394	1488	3152	4,640	9,768
2037	22	4,374	6,098	589	396	1493	3195	4,688	9,869
2038	23	4,388	6,193	590	398	1497	3239	4,737	9,972
2039	24	4,402	6,289	591	400	1502	3284	4,786	10,077
2040	25	4,416	6,386	593	402	1507	3330	4,837	10,183

*values in **bold** are actual recorded values

Overall Total (tonnes): 107,307

Overall Totals (m3): 225,909

Compaction Rate (Combined Residential and Rural): 475.00 kg/m3

Manitoba Conservation and Water Stewardship - Wildlife and Ecosystem Protection Branch, September 9, 2015
Email Correspondence

Oswald Wohlgemut

From: Friesen, Chris (CWS) [Chris.Friesen@gov.mb.ca]
Sent: Wednesday, September 09, 2015 9:40 AM
To: 'Oswald Wohlgemut'
Subject: RE: Altona Waste Disposal Ground Expansion - Species at Risk

Oswald

Thank you for your information request. I completed a search of the Manitoba Conservation Data Centre's rare species database and found no occurrences at this time for your area of interest.

The information provided in this letter is based on existing data known to the Manitoba Conservation Data Centre at the time of the request. These data are dependent on the research and observations of CDC staff and others who have shared their data, and reflect our current state of knowledge. **An absence of data in any particular geographic area does not necessarily mean that species or ecological communities of concern are not present;** in many areas, comprehensive surveys have never been completed. Therefore, this information should be regarded neither as a final statement on the occurrence of any species of concern, nor as a substitute for on-site surveys for species as part of environmental assessments.

Because the Manitoba CDC's Biotics database is continually updated and because information requests are evaluated by type of action, any given response is only appropriate for its respective request. Please contact the Manitoba CDC for an update on this natural heritage information if more than six months pass before it is utilized.

Third party requests for products wholly or partially derived from Biotics must be approved by the Manitoba CDC before information is released. Once approved, the primary user will identify the Manitoba CDC as data contributors on any map or publication using Biotics data, as follows as: Data developed by the Manitoba Conservation Data Centre; Wildlife Branch, Manitoba Conservation and Water Stewardship.

This letter is for information purposes only - it does not constitute consent or approval of the proposed project or activity, nor does it negate the need for any permits or approvals required by the Province of Manitoba.

We would be interested in receiving a copy of the results of any field surveys that you may undertake, to update our database with the most current knowledge of the area.

If you have any questions or require further information please contact me directly at (204) 945-7747.

Chris Friesen
Coordinator
Manitoba Conservation Data Centre
204-945-7747
chris.friesen@gov.mb.ca
<http://www.gov.mb.ca/conservation/cdc/>

From: Oswald Wohlgemut [<mailto:owohlgemut@jrcc.ca>]
Sent: September-03-15 3:54 PM
To: Friesen, Chris (CWS)
Subject: Altona Waste Disposal Ground Expansion - Species at Risk

Hello Chris,

J.R. Cousin Consultants is preparing an Environment Act Proposal on behalf of the Town of Altona for the expansion of the existing waste disposal ground. The construction works will occur on SE 27-2-1 WPM (see attached plans). The site is cleared and currently maintained as agricultural land, therefore tree removal will not be required for the construction works. The site is surrounded by agricultural land. Works will include expansion cell construction, leachate pond construction, fence installation and ditch construction.

Please provide information on any at risk wildlife and plant species that are known to exist in the locations outlined above, as well as any registered habitat areas, or known migrating bird species as we would like to include that information in the EAP.

Please let us know if you have any questions.

Thank you,

Oswald Wohlgemut, M.Sc.
Environmental Scientist

J.R. Cousin Consultants Ltd.
Phone: (204) 489-0474
Fax: (204) 489-0487
www.jrcc.ca

The information contained in this email and any attachments is privileged, confidential and subject to copyright. It is intended solely for the use of the person(s) to whom it is addressed. If you receive this email in error, please notify the sender by return email and permanently delete it from your system. Note: We have taken precautions against viruses, but take no responsibility for loss or damage caused by any virus present.

Appendix C

Test Hole Logs

AMEC Foster Wheeler Soils Analysis Report, October 28, 2015

AMEC Foster Wheeler Soils Analysis Report, December 11, 2015

ALS Test Results, August 31, 2015

Test Hole Logs

J. R. Cousin Consultants Ltd.

TEST HOLE LOGS

SYMBOL INDEX

Soils

Well



GW. : Well graded gravels and gravel sand mixtures, little or no fines



Silica Sand



GP. : Poorly graded gravels, gravel - sand mixtures, little or no fines



Bentonite



GM. : Silty gravels, gravel-sand-silt mixtures



Cuttings



GC. : Clayey gravels, gravel-sand-clay mixtures



solid pipe



SW. : Well graded sands, gravelly sands, little or no fines



slotted pipe



SP. : Poorly graded sands, or gravelly sands, little or no fines



SM. : Silty sands, sand-silt mixtures



SC. : Clayey sands, sand-clay mixtures



ML. : Inorganic silts and very fine sands, rock flour, silty or clayey fine sands, or clayey silts with slight plasticity



CL. : Inorganic clays of low plasticity, gravelly clays, sandy or silty clays, lean clays



OL. : Organic silts and organic silty clays of low plasticity



CI. : Inorganic clays of medium or intermediate plasticity



MH. : Inorganic silts, fine sandy or silty soils



CH. : Inorganic clays of high plasticity, fat clays



OH. : Organic clays of medium to high plasticity, organic silts



Pt. : Peat, humus, swamp soils with high organic contents



TOPSOIL

The soil logs are based upon objective data available to us at the time of forming our opinions. The soil logs indicate site specific soil characteristics and must not be generalized over larger areas due to the limited number of test holes as compared to that of an unlimited number of test holes. Every effort is made to evaluate the information by methods generally recognized. The soil logs represent our opinions. J. R. Cousin Consultants Ltd. cannot be responsible for actual site conditions proved to be materially at variance from our analysis or from the data generalization over untested areas.

J. R. Cousin Consultants Ltd.

TEST HOLE LOG SHEET

LOCATION : Altona WDG, SE 27-2-1 WPM

CODE : A-677.05

DATE : August 27, 2015

COORDINATES : 5444976 N, 608245 E

ELEVATION: 241.96m

PROJECT : Town of Altona WDG Expansion EAP

METHOD OF SAMPLING : Drill Rig

TEST HOLE # 1

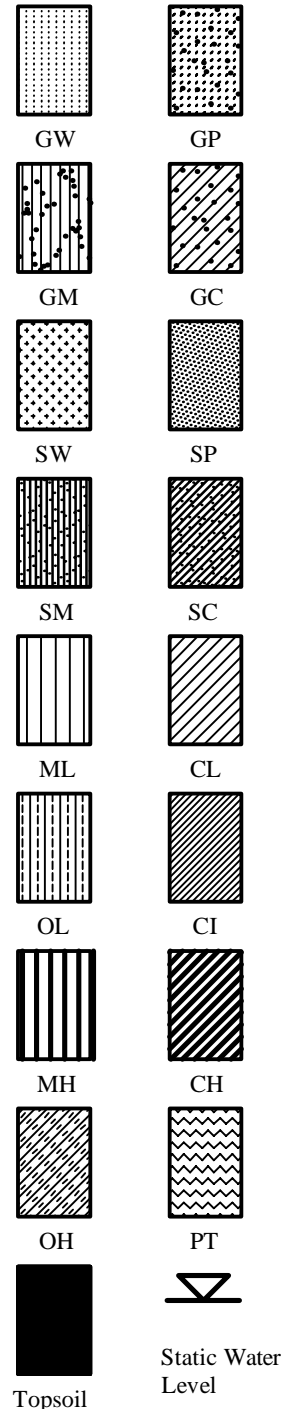
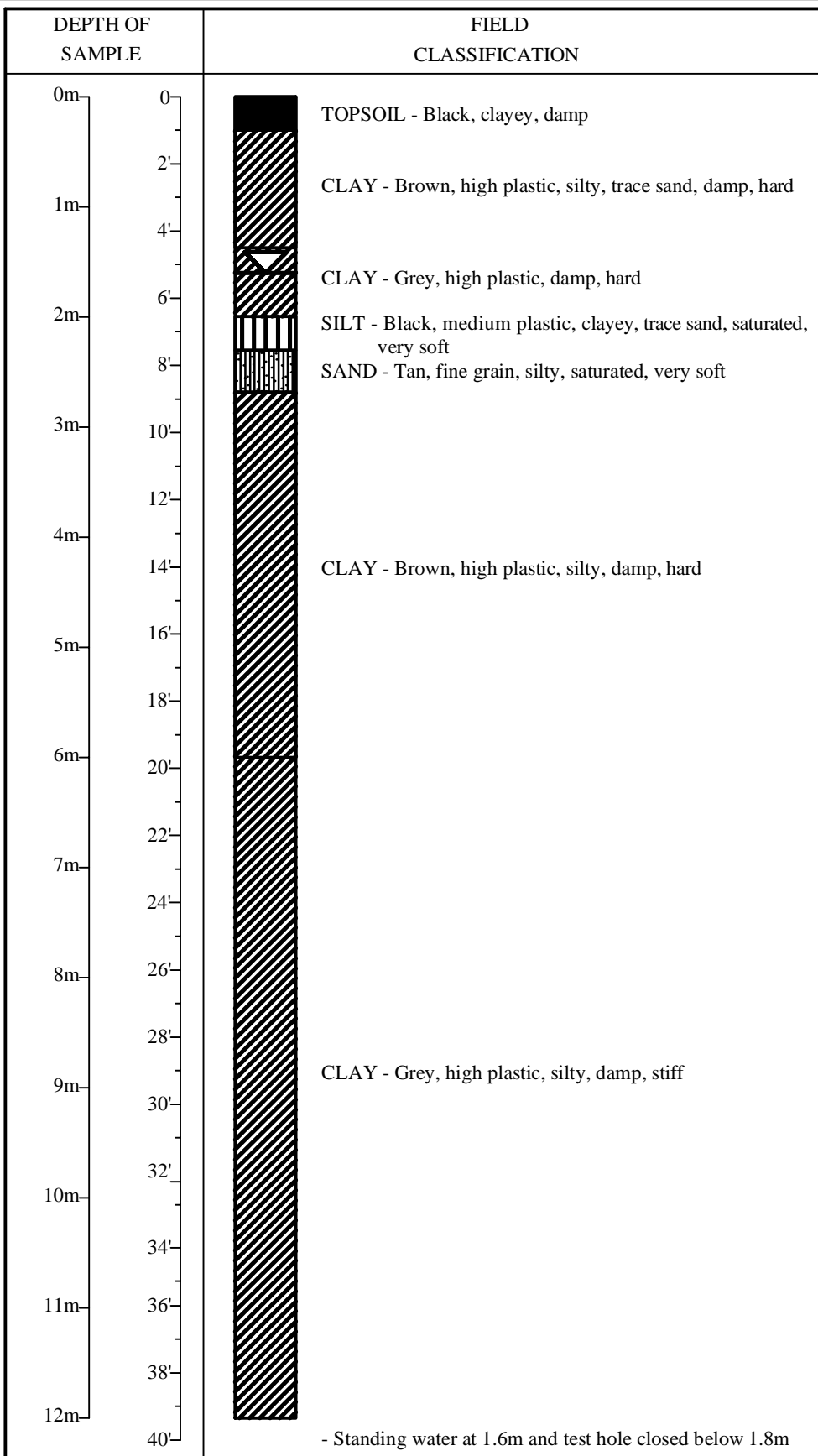

The soil logs are based upon objective data available to us at the time of forming our opinions. The soil logs indicate site specific soil characteristics and must not be generalized over larger areas due to the limited number of test holes as compared to that of a unlimited number of test holes. Every effort is made to evaluate the information by methods generally recognized. The soil represent our opinions. J.R. Cousin Consultants Ltd. cannot be responsible for actual site conditions proved to be materially at variance from our analysis or from the data generalization over untested areas.

J. R. Cousin Consultants Ltd.

TEST HOLE LOG SHEET

LOCATION : Altona WDG, SE 27-2-1 WPM

CODE : A-677.05

DATE : August 27, 2015

COORDINATES : 5445106 N, 608337 E

ELEVATION: 241.79m

PROJECT : Town of Altona WDG Expansion EAP

METHOD OF SAMPLING : Drill Rig

TEST HOLE # 2

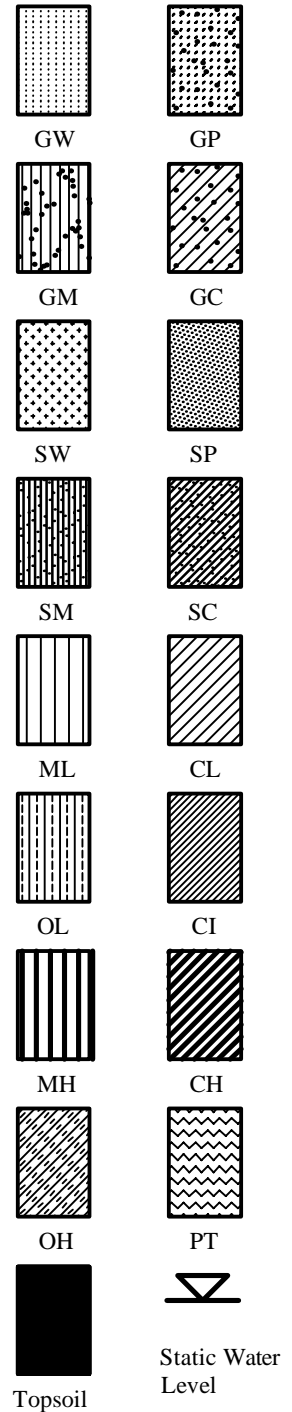
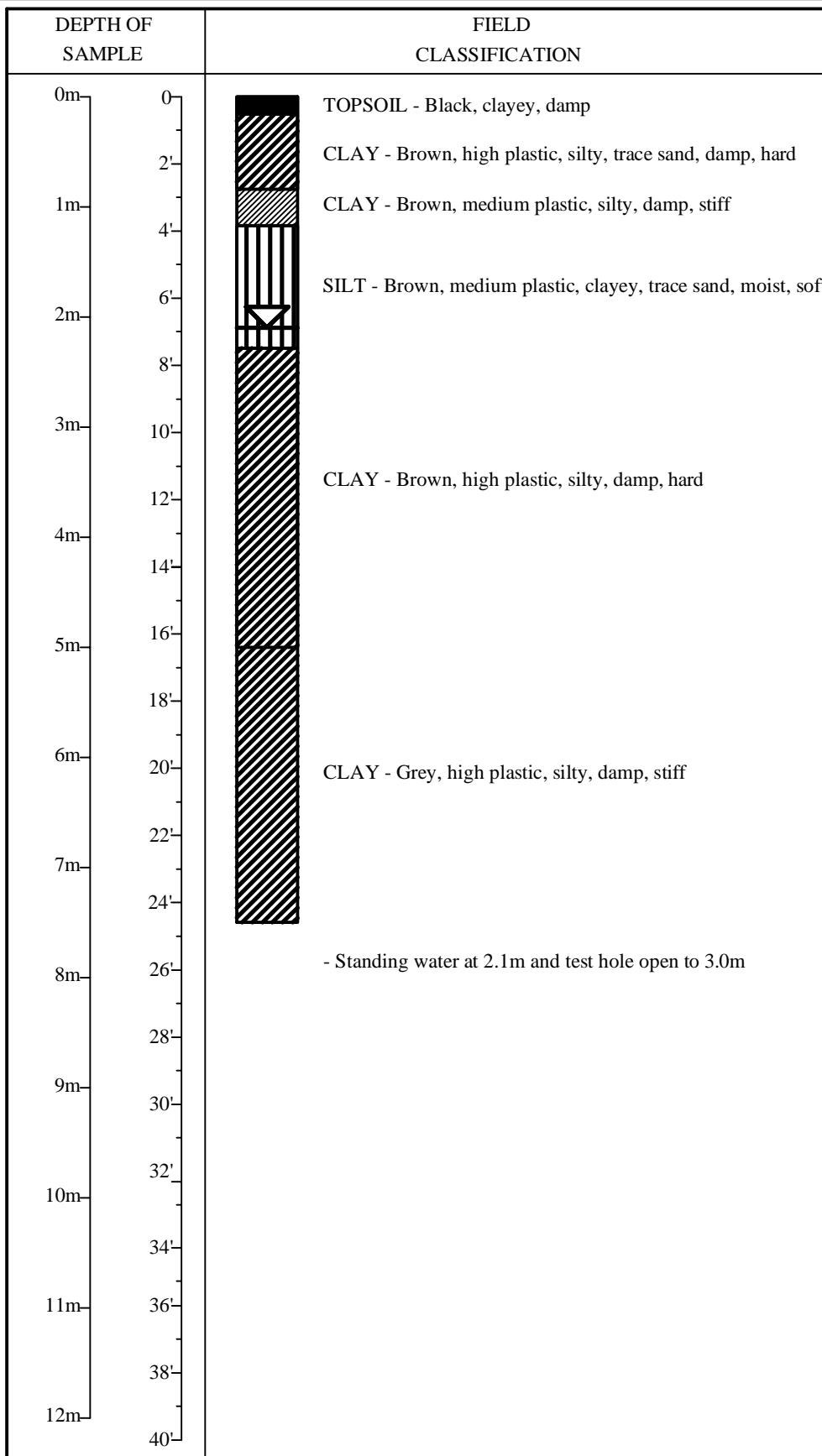

The soil logs are based upon objective data available to us at the time of forming our opinions. The soil logs indicate site specific soil characteristics and must not be generalized over larger areas due to the limited number of test holes as compared to that of an unlimited number of test holes. Every effort is made to evaluate the information by methods generally recognized. The soil represent our opinions. J.R. Cousin Consultants Ltd. cannot be responsible for actual site conditions proved to be materially at variance from our analysis or from the data generalization over untested areas.

J. R. Cousin Consultants Ltd.

TEST HOLE LOG SHEET

LOCATION : Altona WDG, SE 27-2-1 WPM

CODE : A-677.05

DATE : August 27, 2015

COORDINATES : 5445256 N, 608236 E

ELEVATION: 242.01m

PROJECT : Town of Altona WDG Expansion EAP

METHOD OF SAMPLING : Drill Rig

TEST HOLE # 3

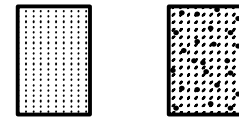
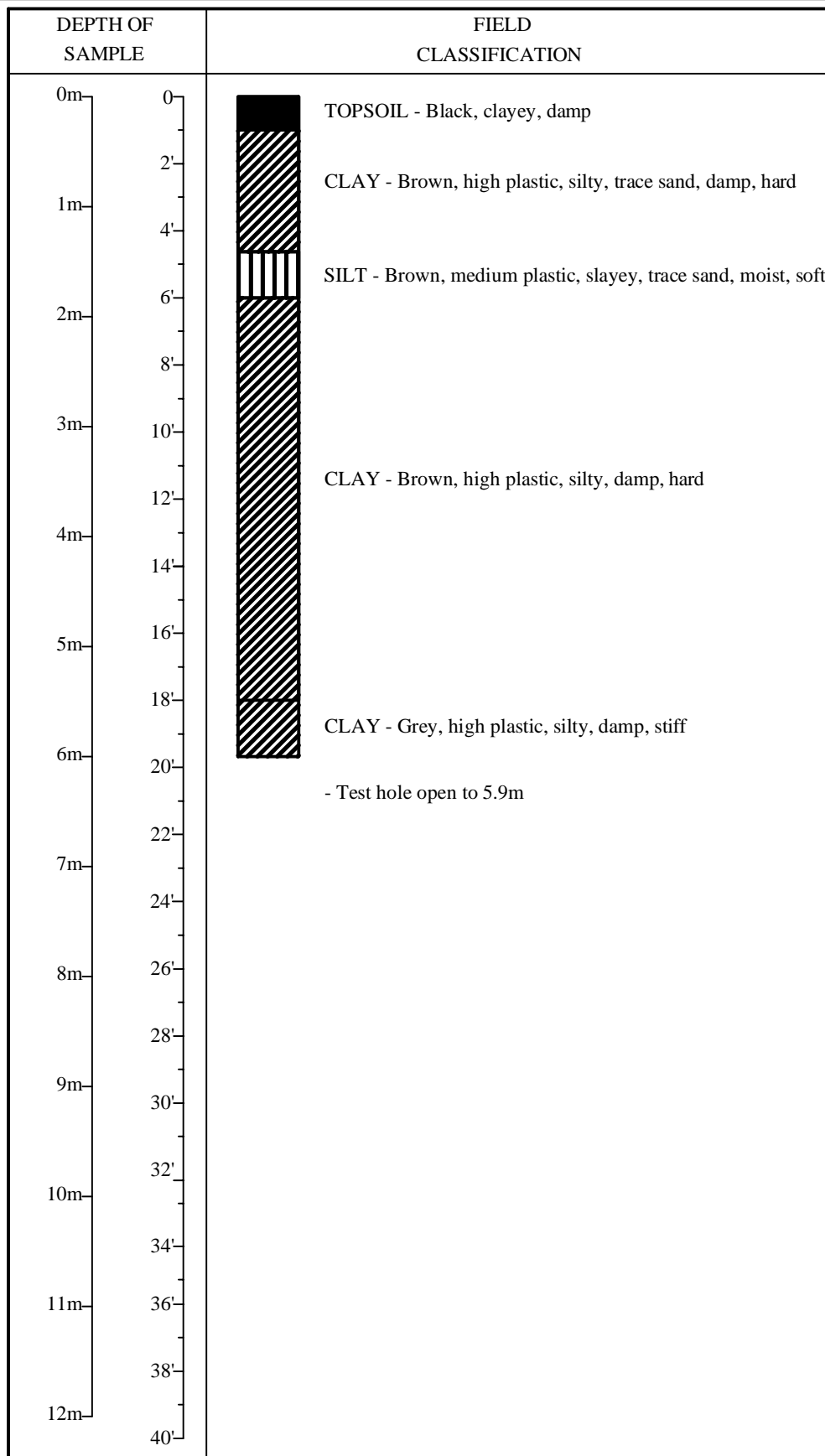

GW

GP



GM

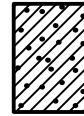

GC

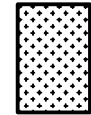

SW



SP



SM



SC



ML

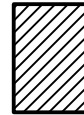

CL



OL



CI

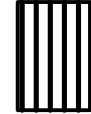

MH



CH



OH



PT



Topsoil



Static Water Level

The soil logs are based upon objective data available to us at the time of forming our opinions. The soil logs indicate site specific soil characteristics and must not be generalized over larger areas due to the limited number of test holes as compared to that of an unlimited number of test holes. Every effort is made to evaluate the information by methods generally recognized. The soil represent our opinions. J.R. Cousin Consultants Ltd. cannot be responsible for actual site conditions proved to be materially at variance from our analysis or from the data generalization over untested areas.

J. R. Cousin Consultants Ltd.

TEST HOLE LOG SHEET

LOCATION : Altona WDG, SE 27-2-1 WPM

CODE : A-677.05

DATE : August 27, 2015

COORDINATES : 5445364 N, 608320 E

ELEVATION: 241.56m

PROJECT : Town of Altona WDG Expansion EAP

METHOD OF SAMPLING : Drill Rig

TEST HOLE # 4

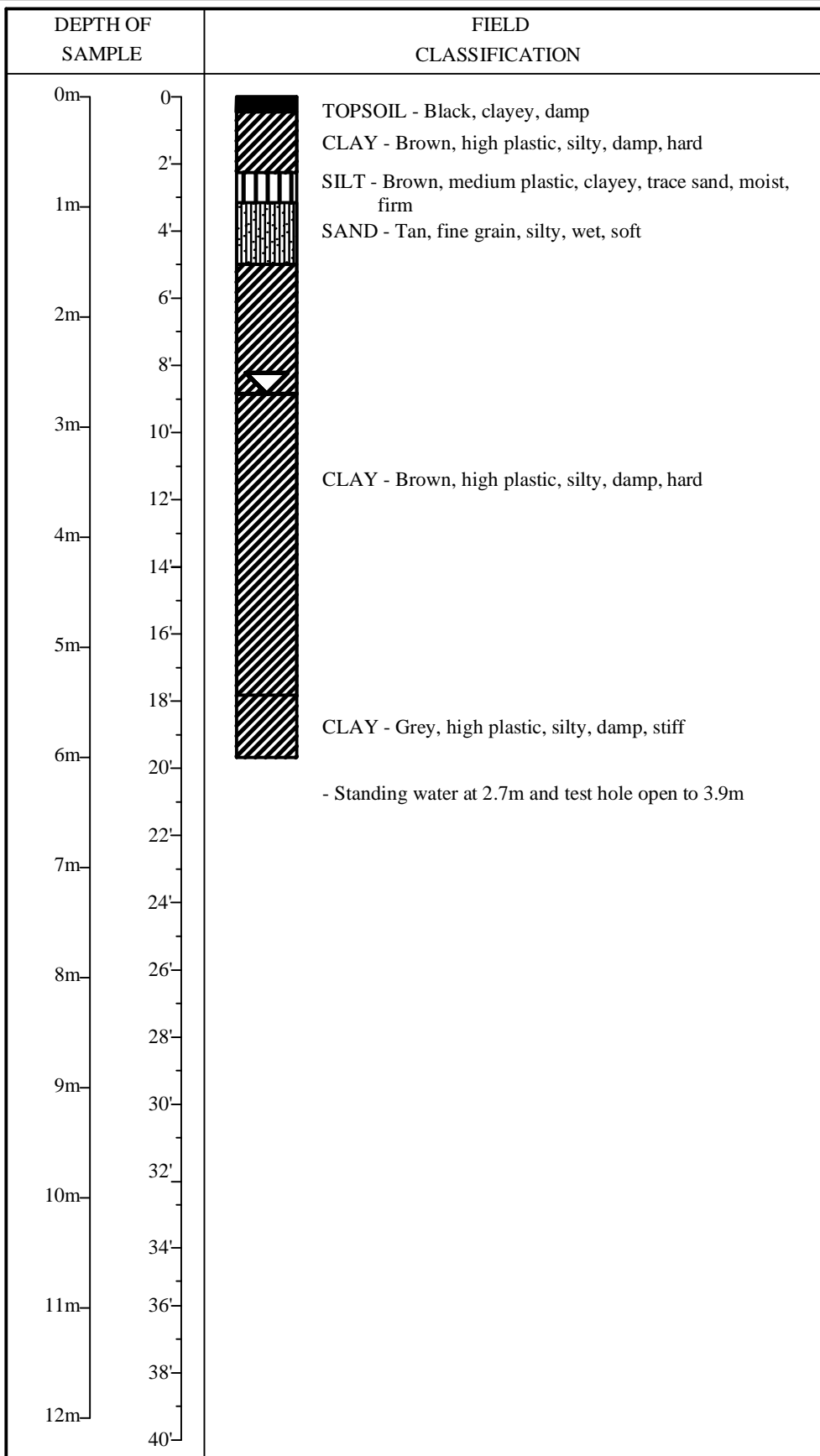

GW	GP
GM	GC
SW	SP
SM	SC
ML	CL
OL	CI
MH	CH
OH	PT
Topsoil	Static Water Level

The soil logs are based upon objective data available to us at the time of forming our opinions. The soil logs indicate site specific soil characteristics and must not be generalized over larger areas due to the limited number of test holes as compared to that of an unlimited number of test holes. Every effort is made to evaluate the information by methods generally recognized. The soil represent our opinions. J.R. Cousin Consultants Ltd. cannot be responsible for actual site conditions proved to be materially at variance from our analysis or from the data generalization over untested areas.

J. R. Cousin Consultants Ltd.

TEST HOLE LOG SHEET

LOCATION : Altona WDG, SE 27-2-1 WPM

CODE : A-677.05

DATE : August 27, 2015

COORDINATES : 5445530 N, 608230 E

ELEVATION: 241.74m

PROJECT : Town of Altona WDG Expansion EAP

METHOD OF SAMPLING : Drill Rig

TEST HOLE # 5

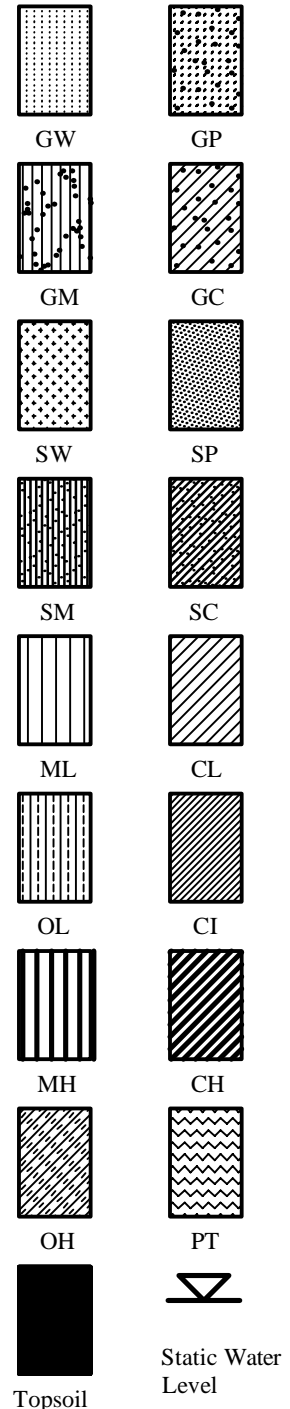
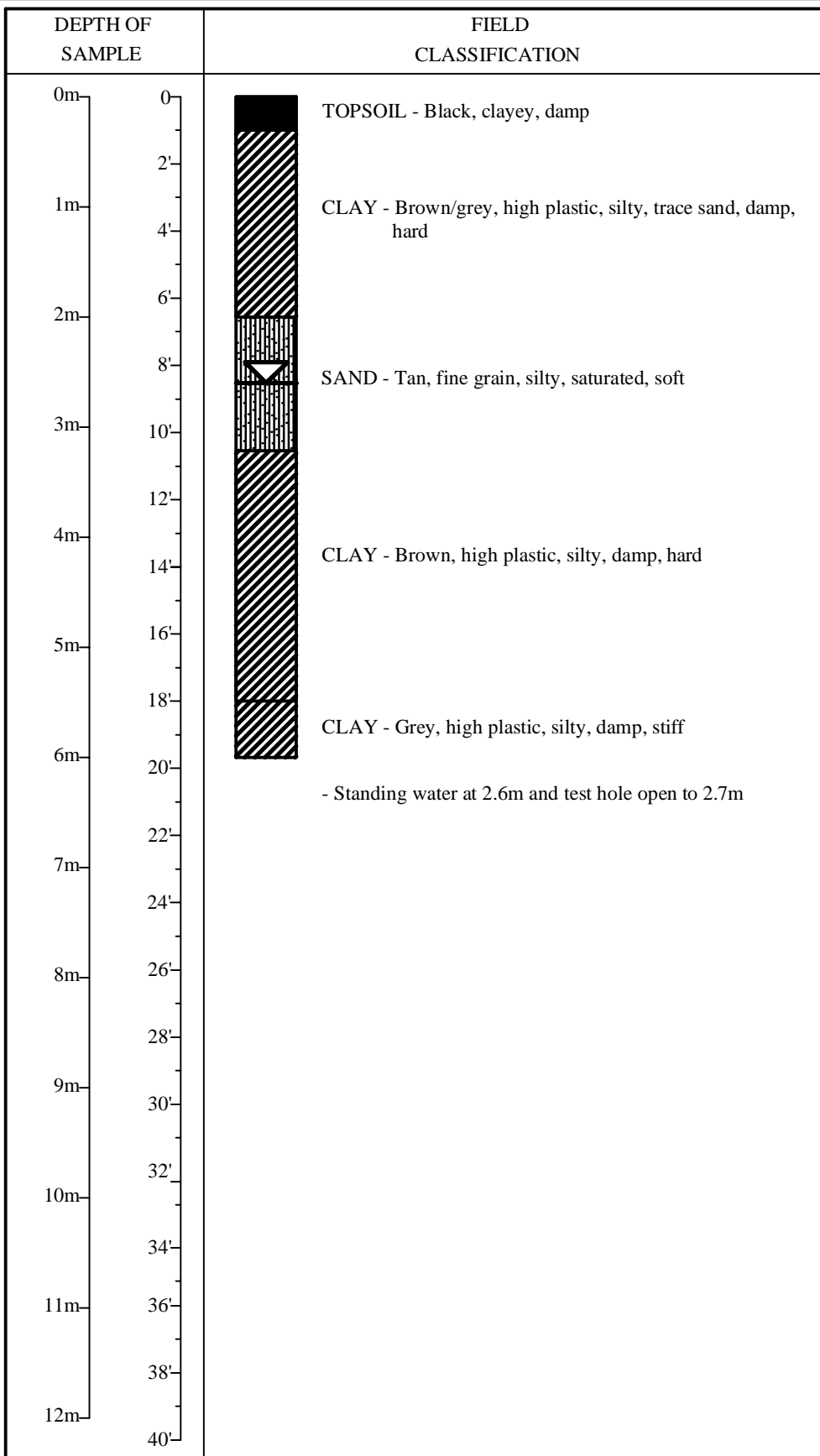

The soil logs are based upon objective data available to us at the time of forming our opinions. The soil logs indicate site specific soil characteristics and must not be generalized over larger areas due to the limited number of test holes as compared to that of an unlimited number of test holes. Every effort is made to evaluate the information by methods generally recognized. The soil represent our opinions. J.R. Cousin Consultants Ltd. cannot be responsible for actual site conditions proved to be materially at variance from our analysis or from the data generalization over untested areas.

J. R. Cousin Consultants Ltd.

TEST HOLE LOG SHEET

LOCATION : Altona WDG, SE 27-2-1 WPM

CODE : A-677.05

DATE : August 27, 2015

COORDINATES : 5445655 N, 608336 E

ELEVATION: 241.78m

PROJECT : Town of Altona WDG Expansion EAP

METHOD OF SAMPLING : Drill Rig

TEST HOLE # 6

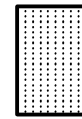
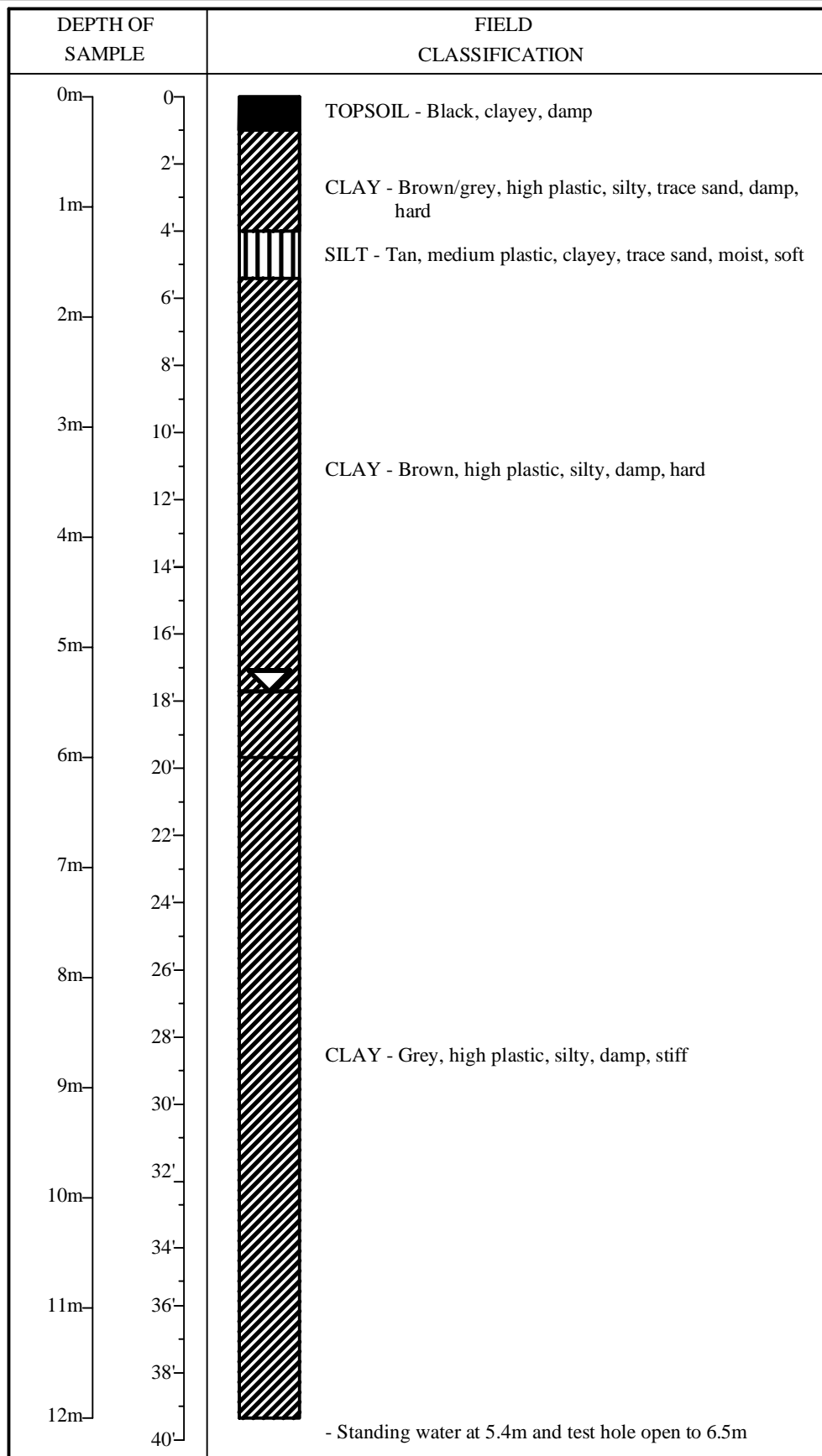

GW

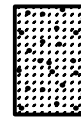

GP

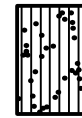

GM

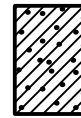

GC



SW



SP

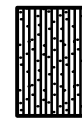

SM



SC

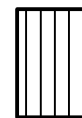

ML

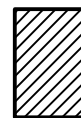

CL



OL



CI

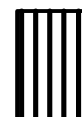

MH



CH



OH



PT



Topsoil

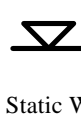

Static Water Level

The soil logs are based upon objective data available to us at the time of forming our opinions. The soil logs indicate site specific soil characteristics and must not be generalized over larger areas due to the limited number of test holes as compared to that of an unlimited number of test holes. Every effort is made to evaluate the information by methods generally recognized. The soil represent our opinions. J.R. Cousin Consultants Ltd. cannot be responsible for actual site conditions proved to be materially at variance from our analysis or from the data generalization over untested areas.

J. R. Cousin Consultants Ltd.

TEST HOLE LOG SHEET

LOCATION : Altona WDG, SE 27-2-1 WPM

CODE : A-677.05

DATE : August 27, 2015

COORDINATES : 5445765 N, 608232E

ELEVATION: 241.72m

PROJECT : Town of Altona WDG Expansion EAP

METHOD OF SAMPLING : Drill Rig

TEST HOLE # 7

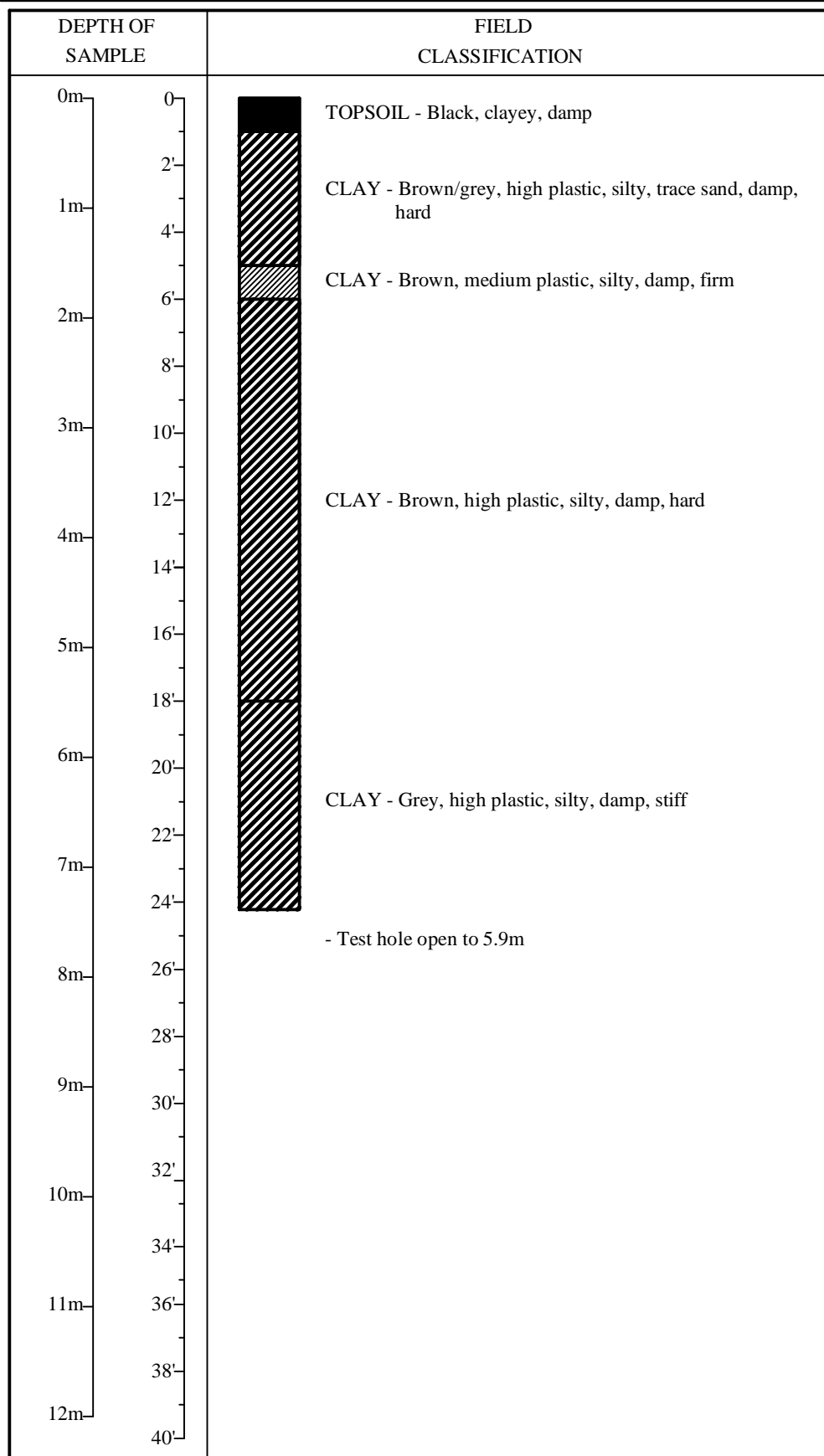

GW	GP
GM	GC
SW	SP
SM	SC
ML	CL
OL	CI
MH	CH
OH	PT
Topsoil	Static Water Level

The soil logs are based upon objective data available to us at the time of forming our opinions. The soil logs indicate site specific soil characteristics and must not be generalized over larger areas due to the limited number of test holes as compared to that of an unlimited number of test holes. Every effort is made to evaluate the information by methods generally recognized. The soil represent our opinions. J.R. Cousin Consultants Ltd. cannot be responsible for actual site conditions proved to be materially at variance from our analysis or from the data generalization over untested areas.

J. R. Cousin Consultants Ltd.

TEST HOLE LOG SHEET

LOCATION : Altona WDG, SE 27-2-1 WPM

CODE : A-677.05

DATE : August 27, 2015

COORDINATES : 5445234 N, 608604E

ELEVATION: 241.69m

PROJECT : Town of Altona WDG Expansion EAP

METHOD OF SAMPLING : Drill Rig

TEST HOLE # 8

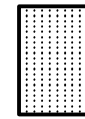
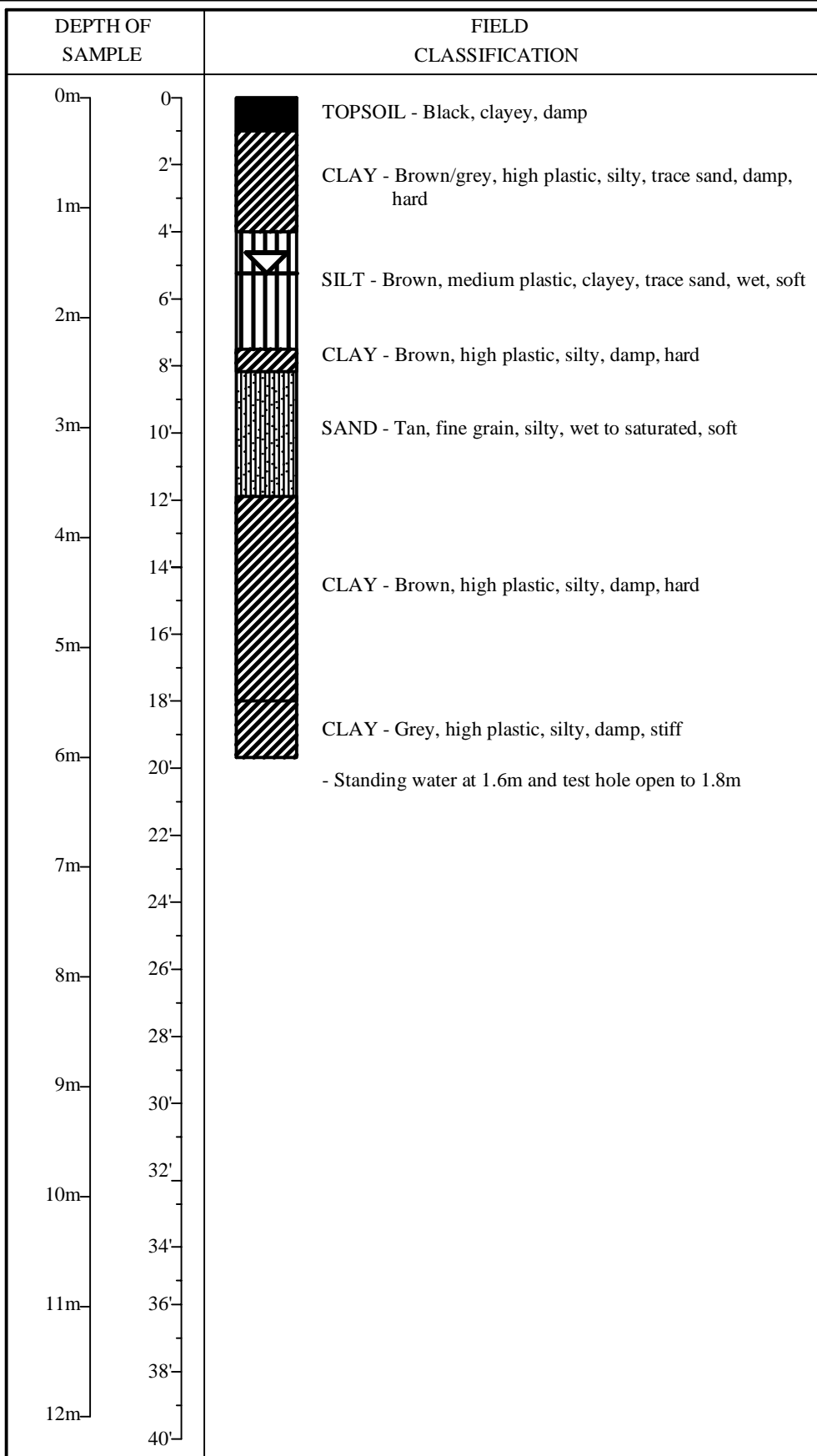

GW

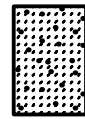

GP

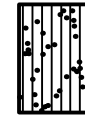

GM

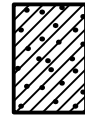

GC



SW

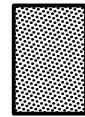

SP



SM



SC

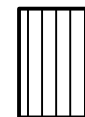

ML

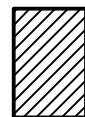

CL



OL



CI



MH

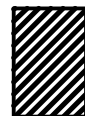

CH



OH



PT



Topsoil



Static Water Level

The soil logs are based upon objective data available to us at the time of forming our opinions. The soil logs indicate site specific soil characteristics and must not be generalized over larger areas due to the limited number of test holes as compared to that of an unlimited number of test holes. Every effort is made to evaluate the information by methods generally recognized. The soil represent our opinions. J.R. Cousin Consultants Ltd. cannot be responsible for actual site conditions proved to be materially at variance from our analysis or from the data generalization over untested areas.

J. R. Cousin Consultants Ltd.

TEST HOLE LOG SHEET

LOCATION : Altona WDG, SE 27-2-1 WPM

CODE : A-677.05

DATE : August 27, 2015

COORDINATES : 5445761 N, 608514E

ELEVATION: 243.22m

PROJECT : Town of Altona WDG Expansion EAP

METHOD OF SAMPLING : Drill Rig

TEST HOLE # 9

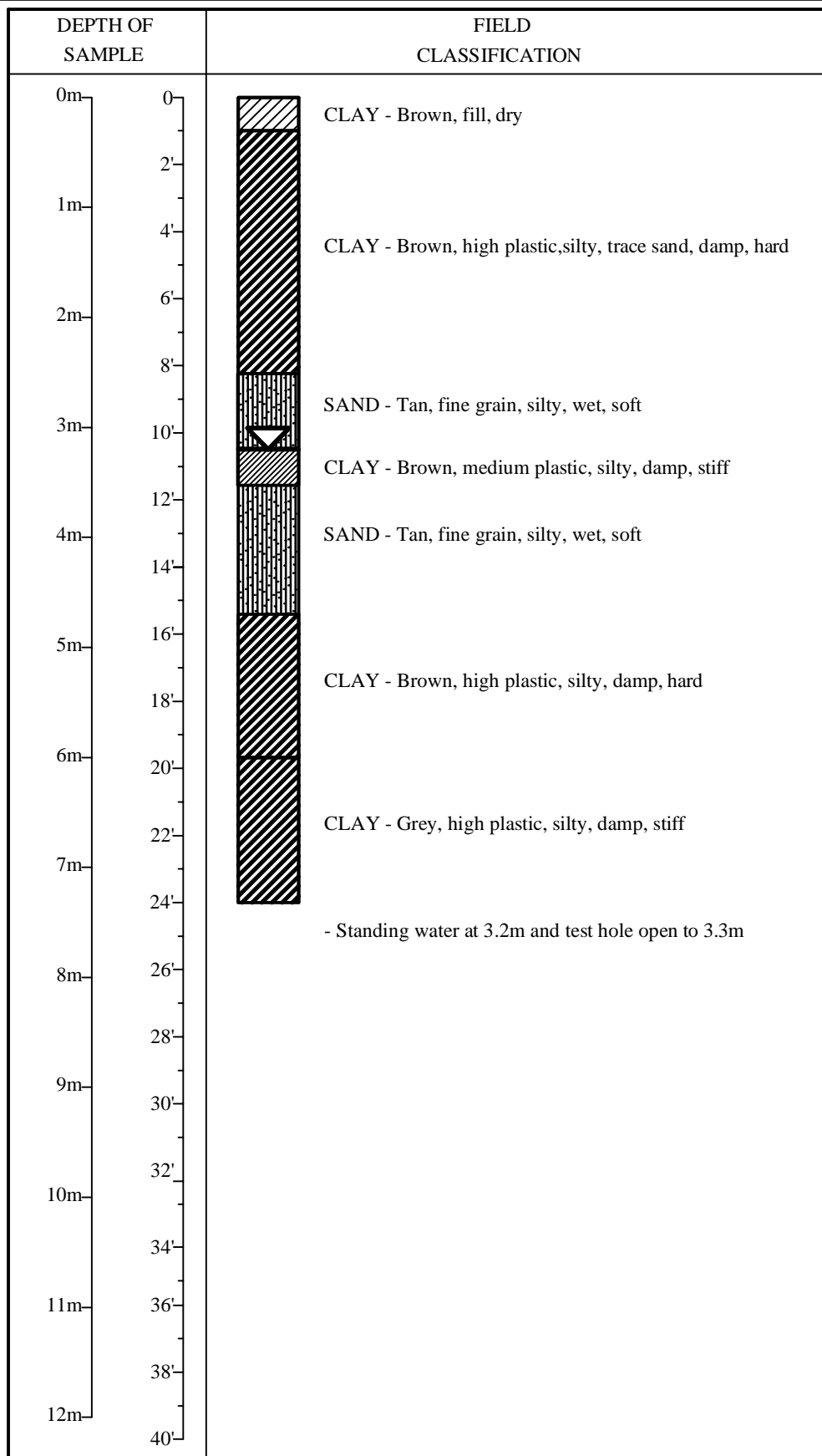

GW	GP
GM	GC
SW	SP
SM	SC
ML	CL
OL	CI
MH	CH
OH	PT
Topsoil	Static Water Level

The soil logs are based upon objective data available to us at the time of forming our opinions. The soil logs indicate site specific soil characteristics and must not be generalized over larger areas due to the limited number of test holes as compared to that of a unlimited number of test holes. Every effort is made to evaluate the information by methods generally recognized. The soil represent our opinions. J.R. Cousin Consultants Ltd. cannot be responsible for actual site conditions proved to be materially at variance from our analysis or from the data generalization over untested areas.

J. R. Cousin Consultants Ltd.

TEST HOLE LOG SHEET

LOCATION : Altona WDG, SE 27-2-1 WPM

CODE : A-677.05

DATE : August 28, 2015

COORDINATES : 5445469 N, 608600E

ELEVATION: 241.47m

PROJECT : Town of Altona WDG Expansion EAP

METHOD OF SAMPLING : Drill Rig

TEST HOLE # 10

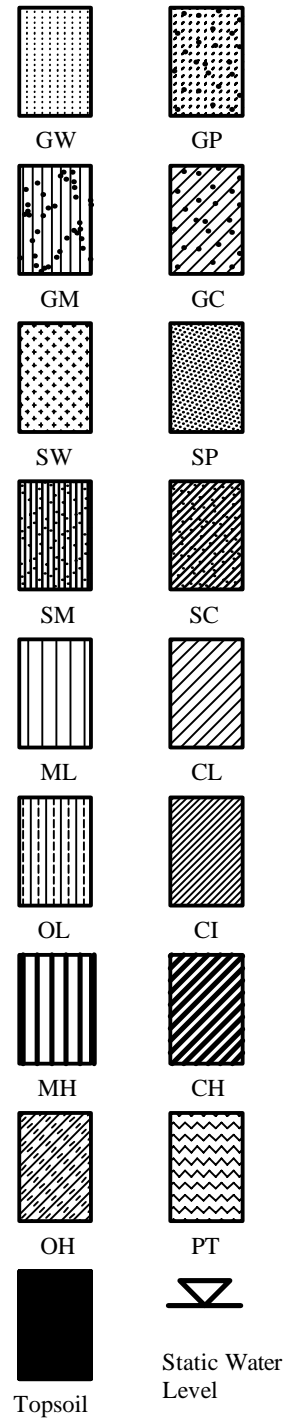
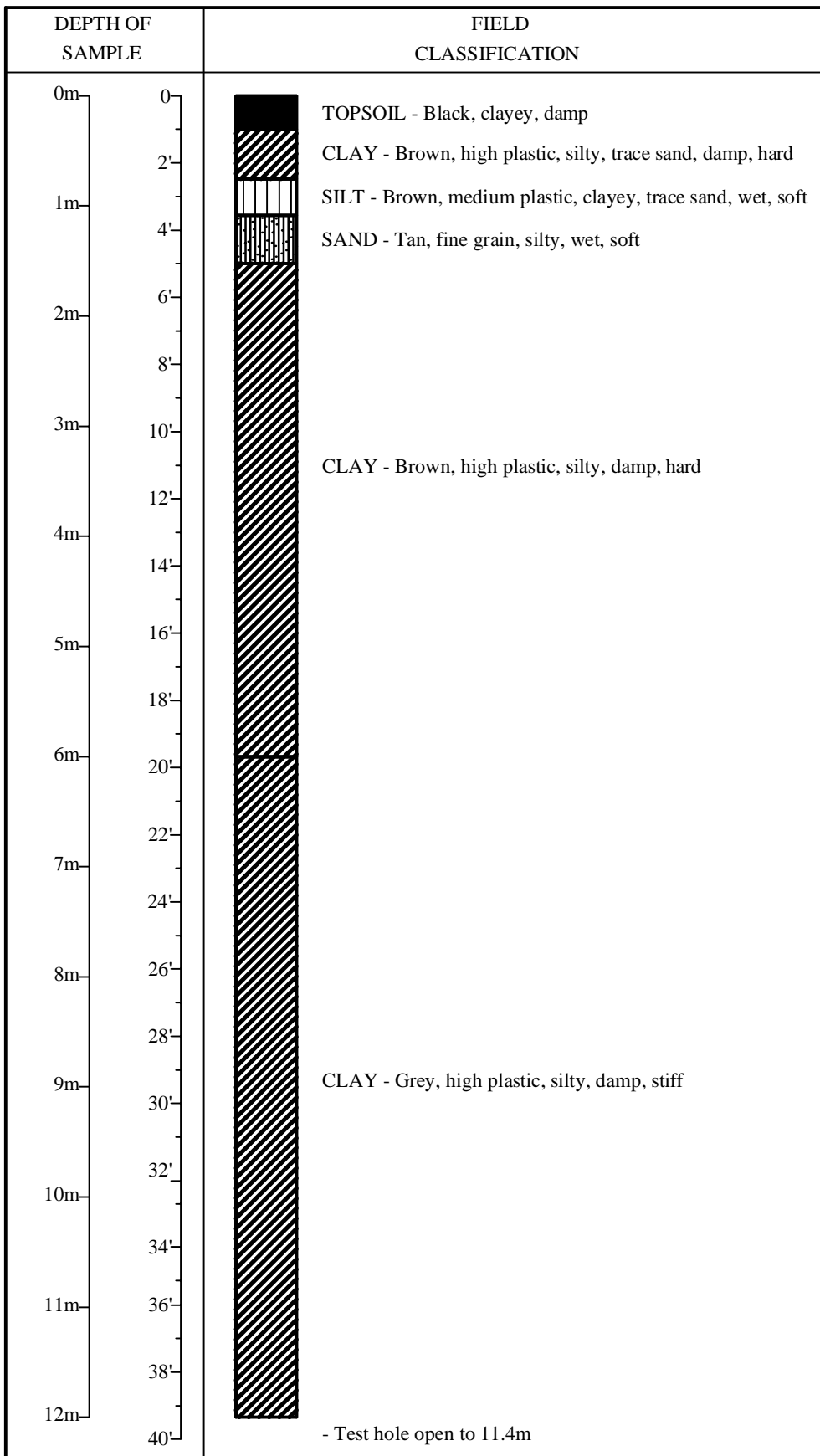

The soil logs are based upon objective data available to us at the time of forming our opinions. The soil logs indicate site specific soil characteristics and must not be generalized over larger areas due to the limited number of test holes as compared to that of an unlimited number of test holes. Every effort is made to evaluate the information by methods generally recognized. The soil represent our opinions. J.R. Cousin Consultants Ltd. cannot be responsible for actual site conditions proved to be materially at variance from our analysis or from the data generalization over untested areas.

J. R. Cousin Consultants Ltd.

TEST HOLE LOG SHEET

LOCATION : Altona WDG, SE 27-2-1 WPM

CODE : A-677.05

DATE : August 28, 2015

COORDINATES : 5445145 N, 608605E

ELEVATION: 241.70m

PROJECT : Town of Altona WDG Expansion EAP

METHOD OF SAMPLING : Drill Rig

TEST HOLE # 11

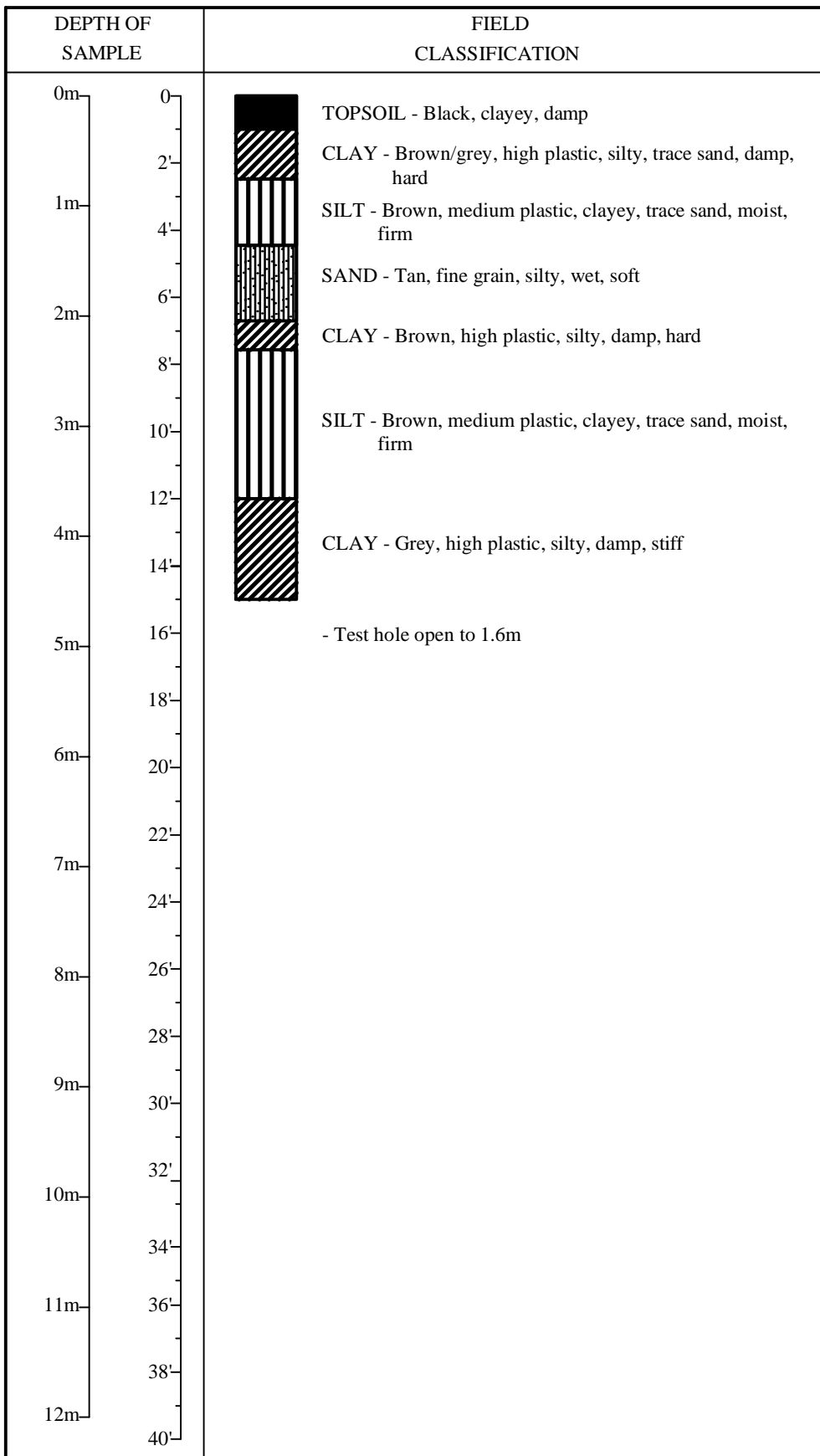

GW	GP
GM	GC
SW	SP
SM	SC
ML	CL
OL	CI
MH	CH
OH	PT
Topsoil	Static Water Level

The soil logs are based upon objective data available to us at the time of forming our opinions. The soil logs indicate site specific soil characteristics and must not be generalized over larger areas due to the limited number of test holes as compared to that of an unlimited number of test holes. Every effort is made to evaluate the information by methods generally recognized. The soil represent our opinions. J.R. Cousin Consultants Ltd. cannot be responsible for actual site conditions proved to be materially at variance from our analysis or from the data generalization over untested areas.

J. R. Cousin Consultants Ltd.

TEST HOLE LOG SHEET

LOCATION : Altona WDG, SE 27-2-1 WPM

CODE : A-677.05

DATE : August 28, 2015

COORDINATES : 5445042 N, 608604E

ELEVATION: 241.84m

PROJECT : Town of Altona WDG Expansion EAP

METHOD OF SAMPLING : Drill Rig

TEST HOLE # 12

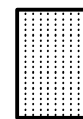
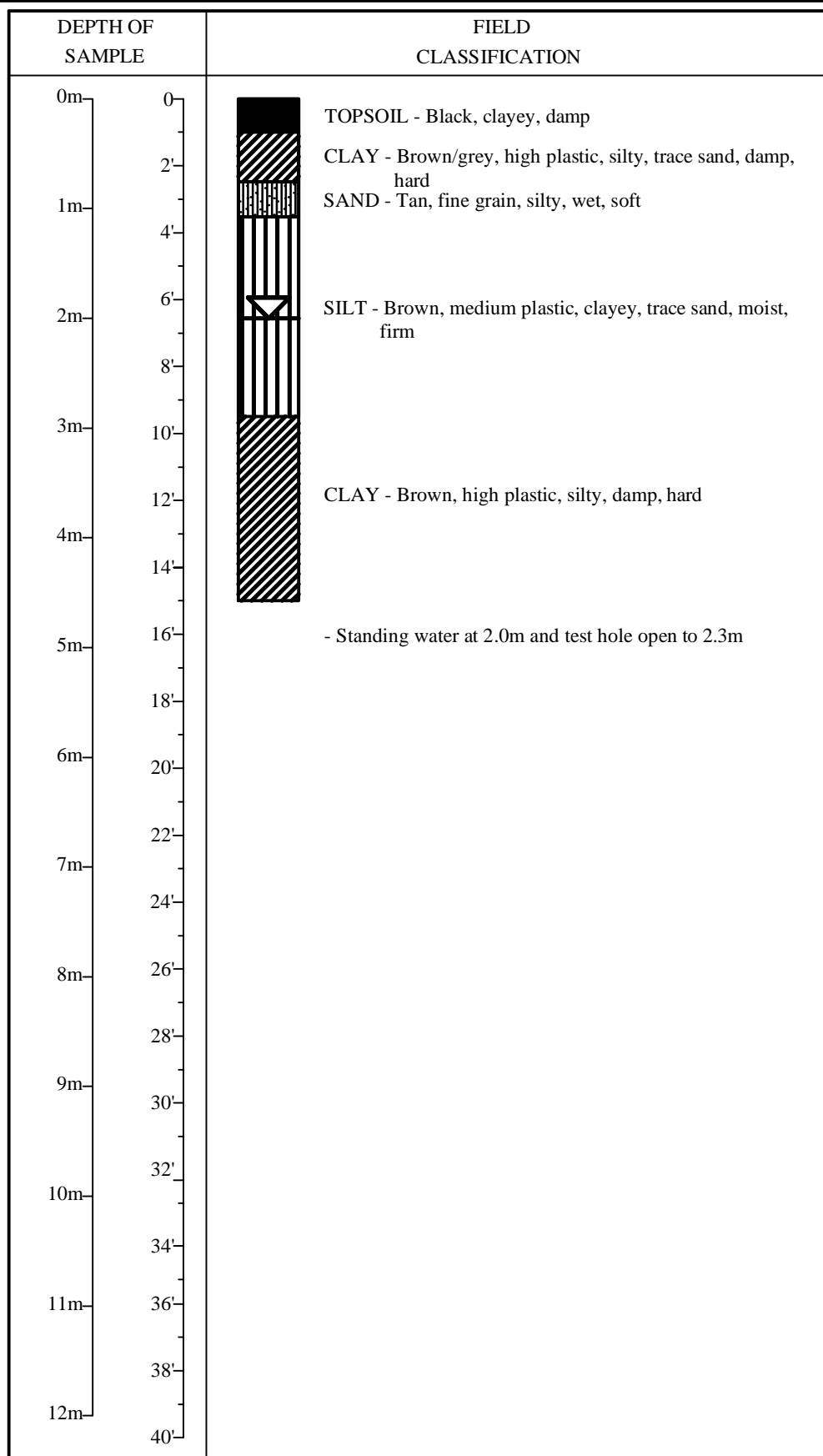

GW



GP

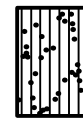

GM

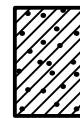

GC



SW

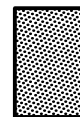

SP



SM



SC

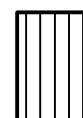

ML



CL



OL



CI



MH



CH



OH



PT



Topsoil



Static Water Level

The soil logs are based upon objective data available to us at the time of forming our opinions. The soil logs indicate site specific soil characteristics and must not be generalized over larger areas due to the limited number of test holes as compared to that of an unlimited number of test holes. Every effort is made to evaluate the information by methods generally recognized. The soil represent our opinions. J.R. Cousin Consultants Ltd. cannot be responsible for actual site conditions proved to be materially at variance from our analysis or from the data generalization over untested areas.

J. R. Cousin Consultants Ltd.

TEST HOLE LOG SHEET

LOCATION : Altona WDG, SE 27-2-1 WPM

CODE : A-677.05

DATE : August 28, 2015

COORDINATES : 5444995 N, 608598E

ELEVATION: 241.94m

PROJECT : Town of Altona WDG Expansion EAP

METHOD OF SAMPLING : Drill Rig

TEST HOLE # 13

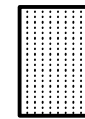
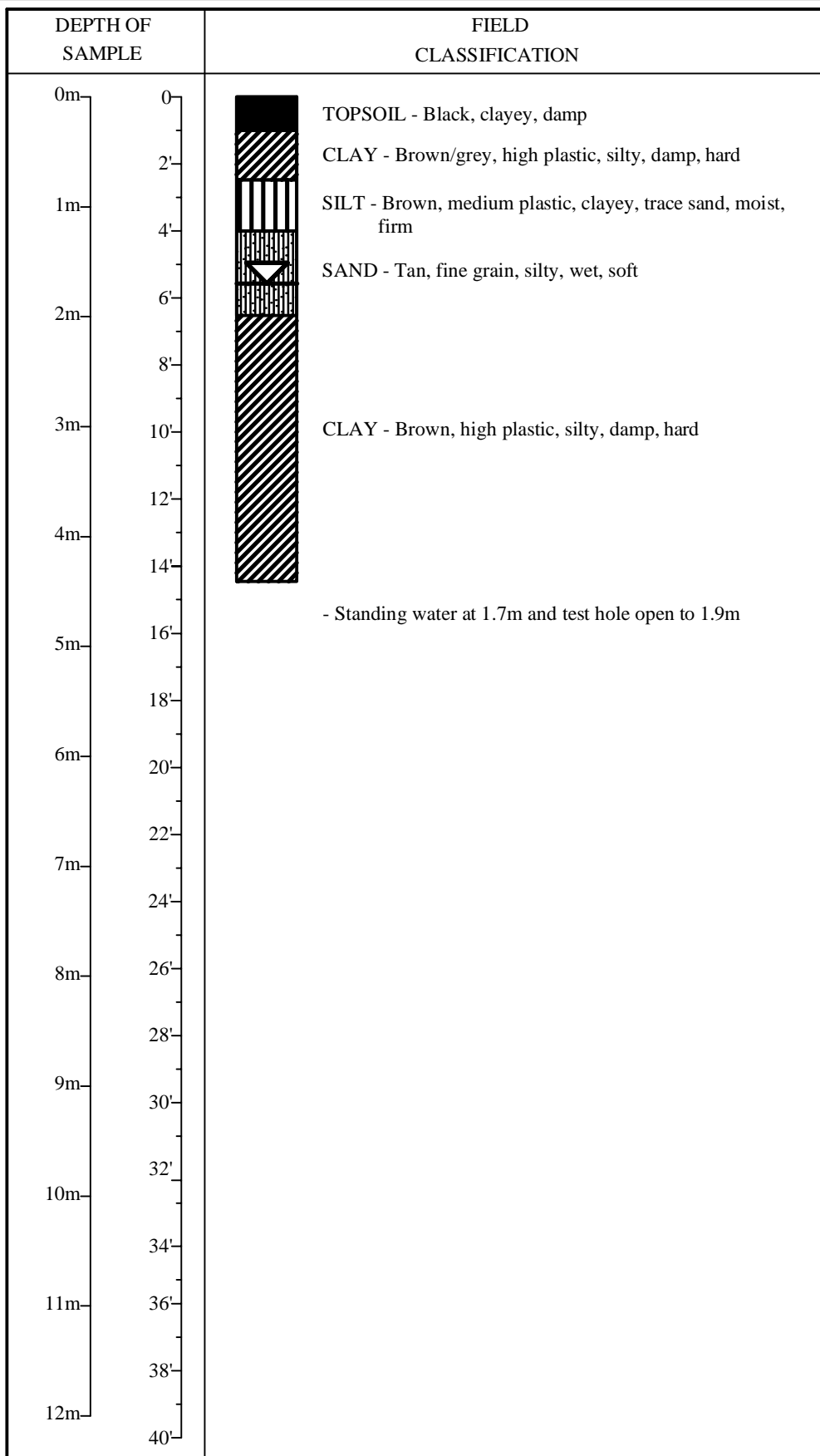

GW

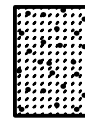

GP

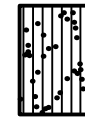

GM

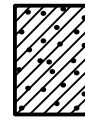

GC



SW



SP

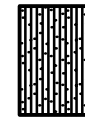

SM



SC

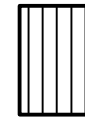

ML

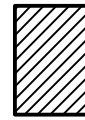

CL



OL



CI

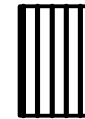

MH



CH



OH

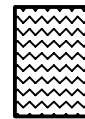

PT



Topsoil



Static Water Level

The soil logs are based upon objective data available to us at the time of forming our opinions. The soil logs indicate site specific soil characteristics and must not be generalized over larger areas due to the limited number of test holes as compared to that of a unlimited number of test holes. Every effort is made to evaluate the information by methods generally recognized. The soil represent our opinions. J.R. Cousin Consultants Ltd. cannot be responsible for actual site conditions proved to be materially at variance from our analysis or from the data generalization over untested areas.

J. R. Cousin Consultants Ltd.

TEST HOLE LOG SHEET

LOCATION : Altona WDG, SE 27-2-1 WPM

CODE : A-677.05

DATE : August 28, 2015

COORDINATES : 5444994 N, 608516E

ELEVATION: 242.23m

PROJECT : Town of Altona WDG Expansion EAP

METHOD OF SAMPLING : Drill Rig

TEST HOLE # 14

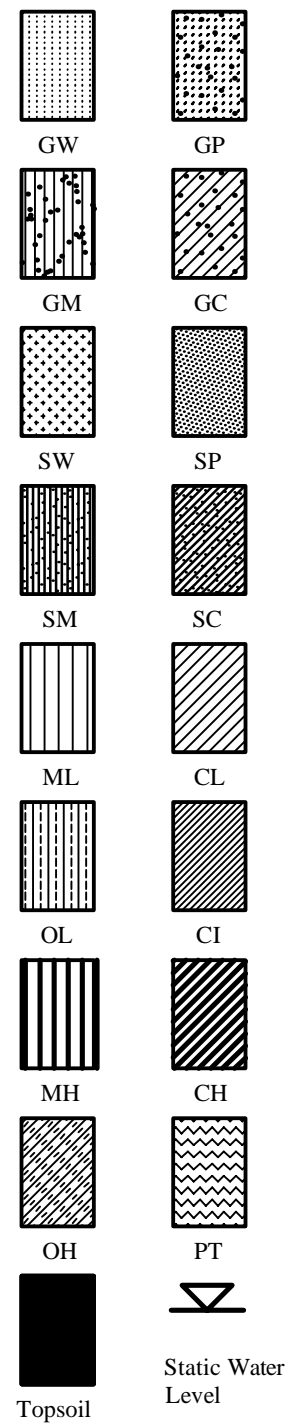
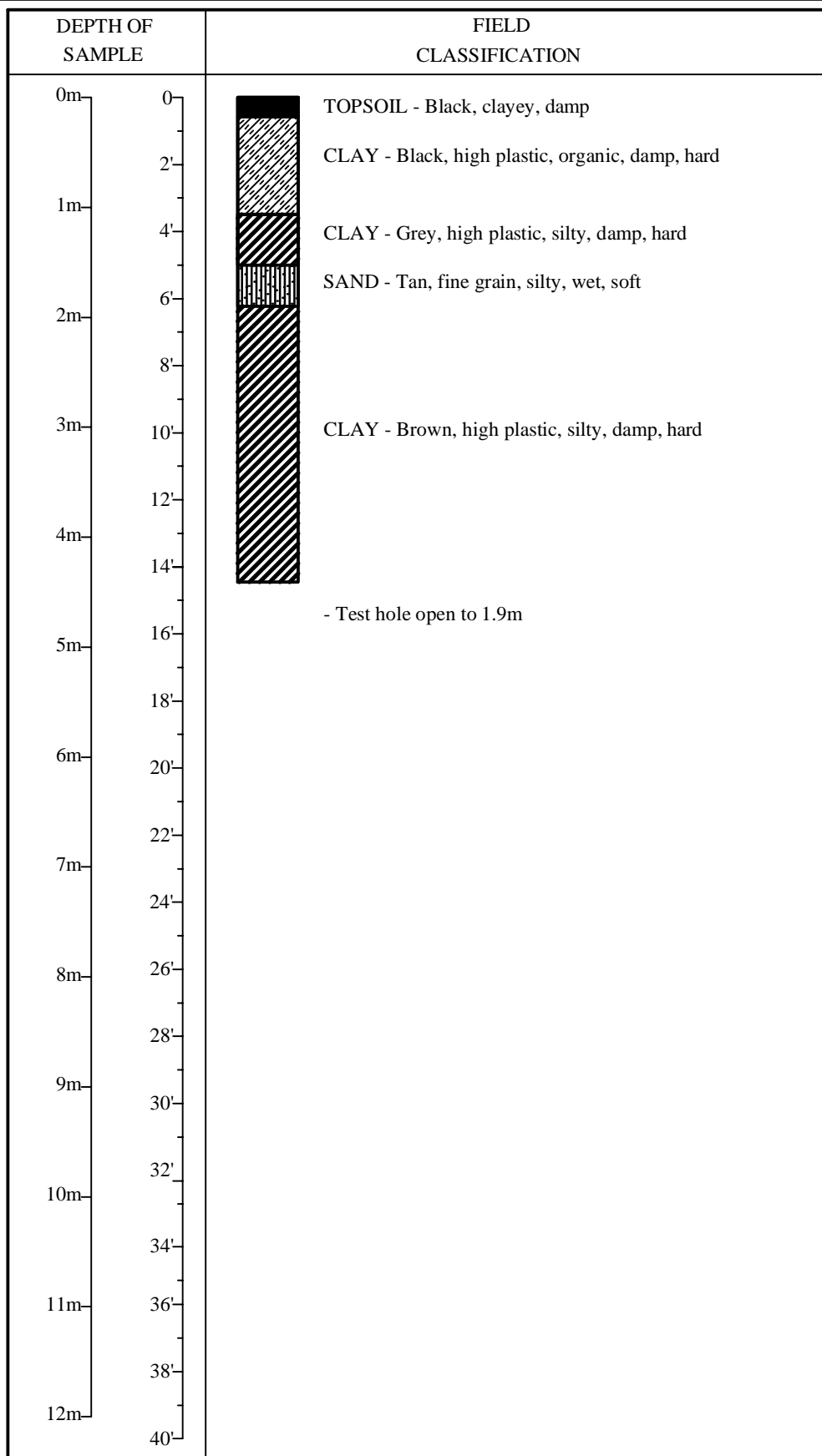

The soil logs are based upon objective data available to us at the time of forming our opinions. The soil logs indicate site specific soil characteristics and must not be generalized over larger areas due to the limited number of test holes as compared to that of a unlimited number of test holes. Every effort is made to evaluate the information by methods generally recognized. The soil represent our opinions. J.R. Cousin Consultants Ltd. cannot be responsible for actual site conditions proved to be materially at variance from our analysis or from the data generalization over untested areas.

J. R. Cousin Consultants Ltd.

TEST HOLE LOG SHEET

LOCATION : Altona WDG, SE 27-2-1 WPM

CODE : A-677.05

DATE : August 28, 2015

COORDINATES : 5444997 N, 608441E

ELEVATION: 242.19m

PROJECT : Town of Altona WDG Expansion EAP

METHOD OF SAMPLING : Drill Rig

TEST HOLE # 15

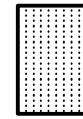
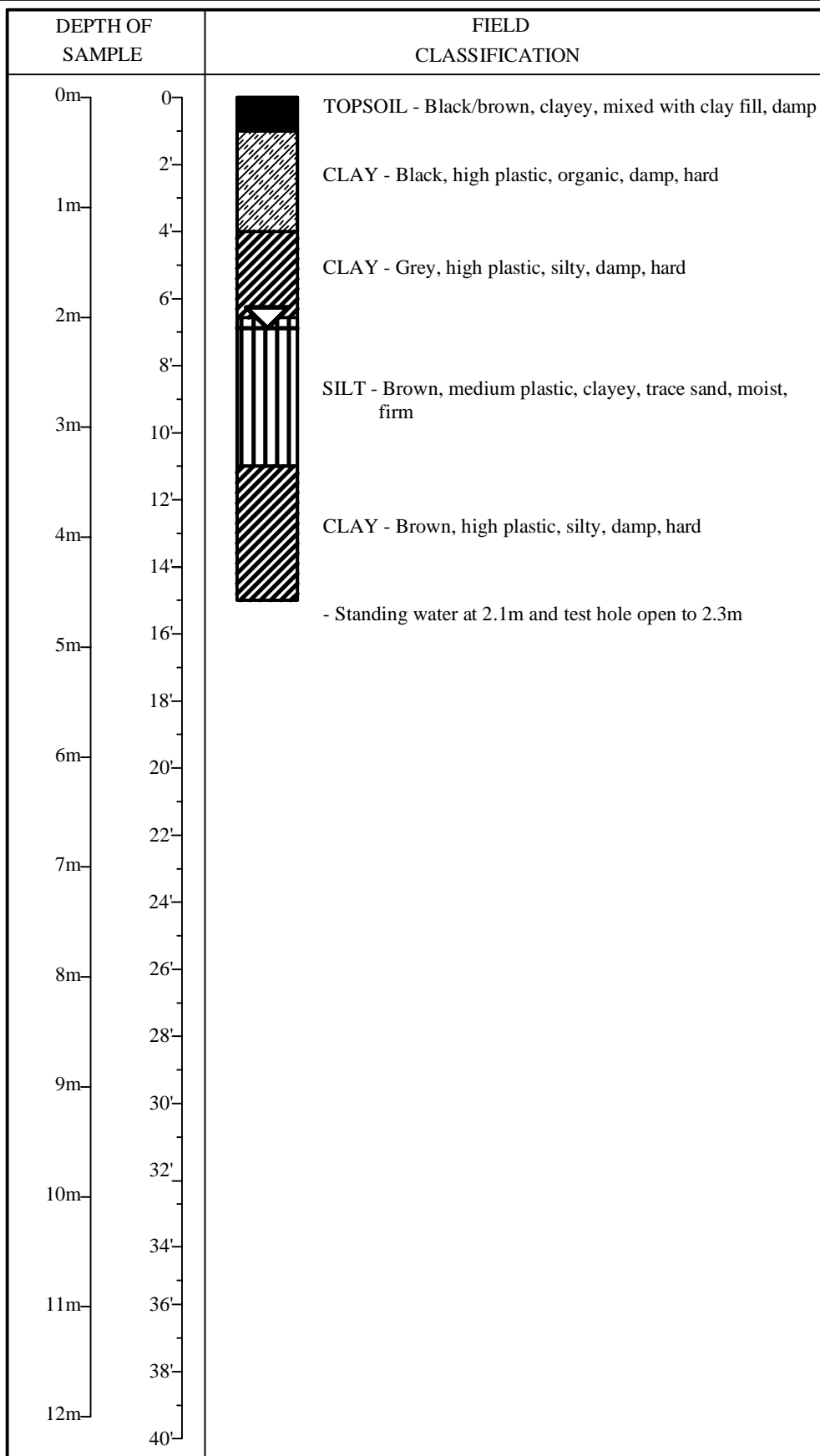

GW

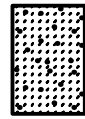

GP

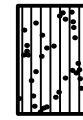

GM

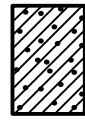

GC



SW

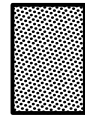

SP



SM



SC

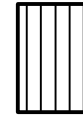

ML

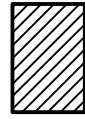

CL



OL

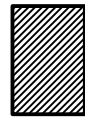

CI

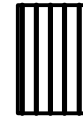

MH

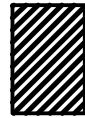

CH



OH



PT



Topsoil



Static Water Level

The soil logs are based upon objective data available to us at the time of forming our opinions. The soil logs indicate site specific soil characteristics and must not be generalized over larger areas due to the limited number of test holes as compared to that of an unlimited number of test holes. Every effort is made to evaluate the information by methods generally recognized. The soil represent our opinions. J.R. Cousin Consultants Ltd. cannot be responsible for actual site conditions proved to be materially at variance from our analysis or from the data generalization over untested areas.

J. R. Cousin Consultants Ltd.

TEST HOLE LOG SHEET

LOCATION : Altona WDG, SE 27-2-1 WPM

CODE : A-677.05

DATE : August 27, 2015

COORDINATES : 5445410 N, 608229 E

ELEVATION: 241.93m

PROJECT : Town of Altona WDG Expansion EAP

METHOD OF SAMPLING : Drill Rig

MONITORING WELL # 1

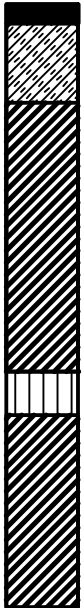
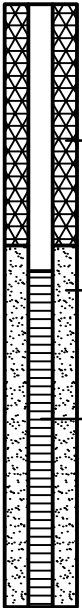
SOIL LOG		WELL INSTALLATION DETAIL	
DEPTH	FIELD CLASSIFICATION	DEPTH	COMMENTS
0m 0' 2' 1m 4' 2m 6' 8' 3m 10' 12' 4m 14' 5m 16' 18' 6m 20' 22' 7m 24' 8m 26' 28' 9m 30' 32' 10m 34' 11m 36' 38' 12m 40'	 <p>TOPSOIL - Black, clayey, damp</p> <p>CLAY - Brown, high plastic, organic, silty, damp, hard</p> <p>CLAY - Brown, high plastic, silty, damp, hard</p> <p>SILT - Tan, medium plastic, clayey, trace sand, wet, soft</p> <p>CLAY - Brown, high plastic, silty, damp, hard</p>	0m 0' 2' 1m 4' 2m 6' 8' 3m 10' 12' 4m 14' 5m 16' 18' 6m 20' 22' 7m 24' 8m 26' 28' 9m 30' 32' 10m 34' 11m 36' 38' 12m 40'	 <p>- top of well located 1.1m above ground surface</p> <p>bentonite</p> <p>sand</p> <p>screen</p>

J. R. Cousin Consultants Ltd.

TEST HOLE LOG SHEET

LOCATION : Altona WDG, SE 27-2-1 WPM

CODE : A-677.05

DATE : August 27, 2015

COORDINATES : 5445295 N, 608605 E

ELEVATION: 241.57m

PROJECT : Town of Altona WDG Expansion EAP

METHOD OF SAMPLING : Drill Rig

MONITORING WELL # 2

SOIL LOG		WELL INSTALLATION DETAIL	
DEPTH	FIELD CLASSIFICATION	DEPTH	COMMENTS
<div style="display: flex; flex-direction: column; align-items: center;"> <div style="margin-bottom: 5px;">0m</div> <div style="margin-bottom: 5px;">2m</div> <div style="margin-bottom: 5px;">1m</div> <div style="margin-bottom: 5px;">4m</div> <div style="margin-bottom: 5px;">2m</div> <div style="margin-bottom: 5px;">8m</div> <div style="margin-bottom: 5px;">3m</div> <div style="margin-bottom: 5px;">10m</div> <div style="margin-bottom: 5px;">12m</div> <div style="margin-bottom: 5px;">4m</div> <div style="margin-bottom: 5px;">14m</div> <div style="margin-bottom: 5px;">5m</div> <div style="margin-bottom: 5px;">16m</div> <div style="margin-bottom: 5px;">18m</div> <div style="margin-bottom: 5px;">6m</div> <div style="margin-bottom: 5px;">20m</div> <div style="margin-bottom: 5px;">22m</div> <div style="margin-bottom: 5px;">7m</div> <div style="margin-bottom: 5px;">24m</div> <div style="margin-bottom: 5px;">8m</div> <div style="margin-bottom: 5px;">26m</div> <div style="margin-bottom: 5px;">28m</div> <div style="margin-bottom: 5px;">9m</div> <div style="margin-bottom: 5px;">30m</div> <div style="margin-bottom: 5px;">10m</div> <div style="margin-bottom: 5px;">32m</div> <div style="margin-bottom: 5px;">34m</div> <div style="margin-bottom: 5px;">11m</div> <div style="margin-bottom: 5px;">36m</div> <div style="margin-bottom: 5px;">38m</div> <div style="margin-bottom: 5px;">12m</div> <div style="margin-bottom: 5px;">40m</div> </div>	<div style="display: flex; flex-direction: column; align-items: center;"> <div style="margin-bottom: 5px;">0</div> <div style="margin-bottom: 5px;">2</div> <div style="margin-bottom: 5px;">4</div> <div style="margin-bottom: 5px;">6</div> <div style="margin-bottom: 5px;">10</div> <div style="margin-bottom: 5px;">12</div> <div style="margin-bottom: 5px;">14</div> <div style="margin-bottom: 5px;">16</div> <div style="margin-bottom: 5px;">18</div> <div style="margin-bottom: 5px;">20</div> <div style="margin-bottom: 5px;">22</div> <div style="margin-bottom: 5px;">24</div> <div style="margin-bottom: 5px;">26</div> <div style="margin-bottom: 5px;">28</div> <div style="margin-bottom: 5px;">30</div> <div style="margin-bottom: 5px;">32</div> <div style="margin-bottom: 5px;">34</div> <div style="margin-bottom: 5px;">36</div> <div style="margin-bottom: 5px;">38</div> <div style="margin-bottom: 5px;">40</div> </div>	<div style="display: flex; flex-direction: column; align-items: center;"> <div style="margin-bottom: 5px;">0m</div> <div style="margin-bottom: 5px;">2m</div> <div style="margin-bottom: 5px;">1m</div> <div style="margin-bottom: 5px;">4m</div> <div style="margin-bottom: 5px;">2m</div> <div style="margin-bottom: 5px;">8m</div> <div style="margin-bottom: 5px;">3m</div> <div style="margin-bottom: 5px;">10m</div> <div style="margin-bottom: 5px;">12m</div> <div style="margin-bottom: 5px;">4m</div> <div style="margin-bottom: 5px;">14m</div> <div style="margin-bottom: 5px;">5m</div> <div style="margin-bottom: 5px;">16m</div> <div style="margin-bottom: 5px;">18m</div> <div style="margin-bottom: 5px;">6m</div> <div style="margin-bottom: 5px;">20m</div> <div style="margin-bottom: 5px;">22m</div> <div style="margin-bottom: 5px;">7m</div> <div style="margin-bottom: 5px;">24m</div> <div style="margin-bottom: 5px;">8m</div> <div style="margin-bottom: 5px;">26m</div> <div style="margin-bottom: 5px;">28m</div> <div style="margin-bottom: 5px;">9m</div> <div style="margin-bottom: 5px;">30m</div> <div style="margin-bottom: 5px;">10m</div> <div style="margin-bottom: 5px;">32m</div> <div style="margin-bottom: 5px;">34m</div> <div style="margin-bottom: 5px;">11m</div> <div style="margin-bottom: 5px;">36m</div> <div style="margin-bottom: 5px;">38m</div> <div style="margin-bottom: 5px;">12m</div> <div style="margin-bottom: 5px;">40m</div> </div>	<div style="display: flex; flex-direction: column; align-items: center;"> <div style="margin-bottom: 5px;">0</div> <div style="margin-bottom: 5px;">2</div> <div style="margin-bottom: 5px;">4</div> <div style="margin-bottom: 5px;">6</div> <div style="margin-bottom: 5px;">10</div> <div style="margin-bottom: 5px;">12</div> <div style="margin-bottom: 5px;">14</div> <div style="margin-bottom: 5px;">16</div> <div style="margin-bottom: 5px;">18</div> <div style="margin-bottom: 5px;">20</div> <div style="margin-bottom: 5px;">22</div> <div style="margin-bottom: 5px;">24</div> <div style="margin-bottom: 5px;">26</div> <div style="margin-bottom: 5px;">28</div> <div style="margin-bottom: 5px;">30</div> <div style="margin-bottom: 5px;">32</div> <div style="margin-bottom: 5px;">34</div> <div style="margin-bottom: 5px;">36</div> <div style="margin-bottom: 5px;">38</div> <div style="margin-bottom: 5px;">40</div> </div>
	<p>TOPSOIL - Black, clayey, damp</p> <p>CLAY - Brown/grey, high plastic, silty, damp, hard</p> <p>SAND - Tan, fine grain, silty, wet, very soft</p> <p>CLAY - Brown, medium plastic, silty, damp, firm</p> <p>SAND - Tan, fine grain, silty, wet, very soft</p> <p>CLAY - Brown, high plastic, silty, damp, hard</p>		<p>bentonite</p> <p>- top of well located 1.0m above ground surface</p> <p>sand</p> <p>screen</p>

SEE SYMBOL INDEX

J. R. Cousin Consultants Ltd.

TEST HOLE LOG SHEET

LOCATION : Altona WDG, SE 27-2-1 WPM

CODE : A-677.05

DATE : August 27, 2015

COORDINATES : 5445760 N, 608595 E

ELEVATION: 241.87m

PROJECT : Town of Altona WDG Expansion EAP

METHOD OF SAMPLING : Drill Rig

MONITORING WELL # 3

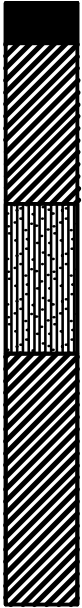
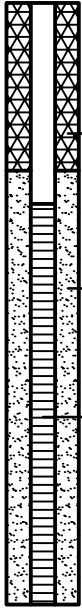
SOIL LOG		WELL INSTALLATION DETAIL	
DEPTH	FIELD CLASSIFICATION	DEPTH	COMMENTS
0m 0' 2' 1m 4' 2m 6' 8' 3m 10' 12' 4m 14' 5m 16' 18' 6m 20' 22' 7m 24' 8m 26' 28' 9m 30' 32' 10m 34' 11m 36' 38' 12m 40'	 <p>TOPSOIL - Black/brown, clayey, mixed with clay fill, damp</p> <p>CLAY - Brown/grey, high plastic, silty, damp, hard</p> <p>SAND - Tan, fine grain, silty, wet, soft</p> <p>CLAY - Brown, high plastic, silty, damp, hard</p>	0m 0' 2' 1m 4' 2m 6' 8' 3m 10' 12' 4m 14' 5m 16' 18' 6m 20' 22' 7m 24' 8m 26' 28' 9m 30' 32' 10m 34' 11m 36' 38' 12m 40'	 <p>- top of well located 0.9m above ground surface</p> <p>bentonite</p> <p>sand</p> <p>screen</p>

SEE SYMBOL INDEX

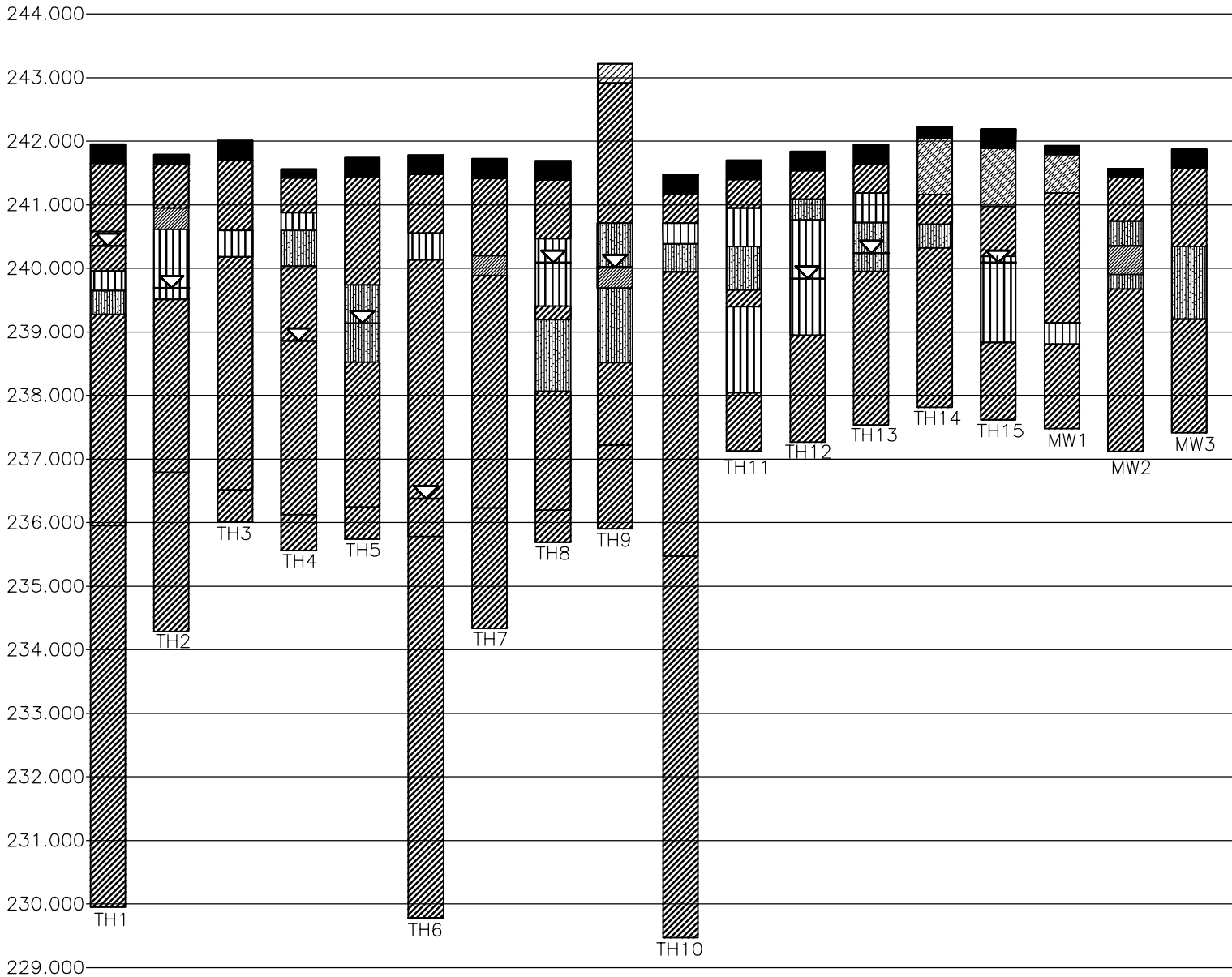

LEGEND:

- TOPSOIL
- OH: ORGANIC CLAYS OF MEDIUM TO HIGH PLASTICITY, ORGANIC SILTS
- CH: INORGANIC CLAYS OF HIGH PLASTICITY, FAT CLAYS
- CI: INORGANIC CLAYS OF MEDIUM OR INTERMEDIATE PLASTICITY
- SM: SILTY SANDS, SAND-SILT MIXTURES
- CL: INORGANIC CLAYS OF LOW PLASTICITY, GRAVELLY CLAYS, SANDY OR SILTY CLAYS, LEAN CLAYS
- ML: INORGANIC SILTS AND VERY FINE SANDS, ROCK FLOUR, SILTY OR CLAYEY FINE SANDS, OR CLAYEY SILTS WITH SLIGHT PLASTICITY
- STATIC WATER LEVEL

Jan 28, 2016 - 4:17pm F:\600\677 Altona, Town\677.05 Waste Disposal Ground Expansion EAP\04 Drawings\DWG\Soil Logs\Altona's Soil Log.dwg

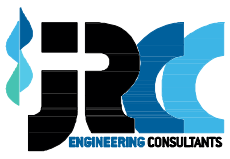

JR Cousin Consultants Ltd.
 91A Scurfield Blvd. Winnipeg MB R3Y 1G4
 p. (204) 489-0474
 f. (204) 489-0487
 www.jrcc.ca

DATE: 15/09/10
 SCALE: 1:100
 PLAN NO.: 1

CLIENT: TOWN OF ALTONA
 PROJECT: WASTE DISPOSAL GROUND EXPANSION EAP
 TITLE: TEST HOLES

AMEC Foster Wheeler Soils Analysis Report, October 28, 2015

AMEC Foster Wheeler Soils Analysis Report, December 11, 2015

28 October 2015

Project No. WX11334-1400



J.R. Cousin Consultants Ltd.

91 Scurfield Boulevard
Winnipeg, Manitoba
R3Y 1G4

Attention: **Mr. Oswald Wohlgemut**

Re: **Soils Analysis
Altona Landfill**

1.0 INTRODUCTION

As authorized by Mr. Oswald Wohlgemut of J.R. Cousin Consultants Ltd. (JRCC), Amec Foster Wheeler Environment and Infrastructure, a division of Amec Foster Wheeler Americas Ltd. (Amec Foster Wheeler), has completed an evaluation of 4 soil samples (grab samples) that were submitted to our office by JRCC. Visual classification, Atterberg limits, particle size and moisture content testing were requested along with a proctor test. A hydraulic conductivity test was also requested on an undisturbed sample. Comments relating to suitability of the soils to be used as a cell liner were also requested.

2.0 LABORATORY TESTING

On receipt, the grab samples were visually classified in accordance with the Modified Unified Soil Classification System and were tested for moisture content, particle size (hydrometer method) and Atterberg limits. The visual classification and laboratory testing results are summarized in Table 1 with the laboratory data summary also appended to this report.

Table 1: Lab Results

Sample Number	Depth (m)	Water Content (%)	Atterberg Limits			Particle Size Analysis			
			Liquid Limit (%)	Plastic Limit (%)	Plasticity Index	% Gravel	% Sand	% Silt	% Clay
TH02	1.2 – 2.4	30.0	41	15	26	0	1.5	66.7	33.8
	Classification: CI– Silt, Clayey, trace sand, medium plastic, moist								
TH05	0.4 – 2.0	36.9	97	27	70	0	0.7	21.2	78.2
	Classification: CH – Clay, silty, trace sand, high plastic, moist								
TH05	3.2 – 6.0	46.9	89	20	69	0	0.6	21.5	77.9
	Classification: CH – Clay, silty, trace sand, high plastic, moist								
TH12	0.3 – 0.8	28.6	61	18	43	0	3.5	51.7	44.8
	Classification: CH – Silt and Clay, trace sand, high plastic, moist								

Note: Sample information provided by JRCC

An undisturbed hydraulic conductivity test was also undertaken on sample from TH5 (4.5 to 5.1m) as per JRCC and the. Results were as follows:

TH05 – 1.5 to 2.1m
Hydraulic Conductivity – 1.87×10^{-8} cm/sec; (undisturbed)

3.0 DISCUSSION

Amec Foster Wheeler was requested to comment on the suitability of the soils for use as a liner in a re-compacted condition, based on the visual assessment and the test results summarized in Table 1 above. Feasibility for the utilization of the various materials as an impermeable liner for the proposed lagoon liner will largely depend on the quality and amount of the clay available. Typical engineering practice is to specify materials that comply with the following minimum parameters:

- Liquid Limit of 30% or greater ;
- Plastic Index of 10% or greater;
- 30% or more passing a number 200 mesh sieve; and
- 20% or more of clay particles (2- μ m particle size)

In general, materials meeting the combination of characteristics noted above would provide a liner having a hydraulic conductivity not exceeding 1×10^{-7} cm/sec. Based on the laboratory test data for these samples, the samples submitted to our office would meet the criteria. The hydraulic conductivity test completed on the undisturbed sample further indicates that the high plastic soils noted in the above table will likely achieve the requirement of a maximum of 1×10^{-7} cm/sec.

4.0 CLOSURE

Amec Foster Wheeler trusts that the forgoing is sufficient for your present requirements. Should you require additional information, please contact the undersigned at this office.

Sincerely,
Amec Foster Wheeler Environment & Infrastructure
A Division of Amec Foster Wheeler Americas Limited

Trevor Gluck, P. Eng.
Senior Geotechnical Engineer

Reviewed By:
Harley Pankratz, P. Eng.

Attachments;
Lab Summary (1)
Hydraulic Conductivity Test (1)

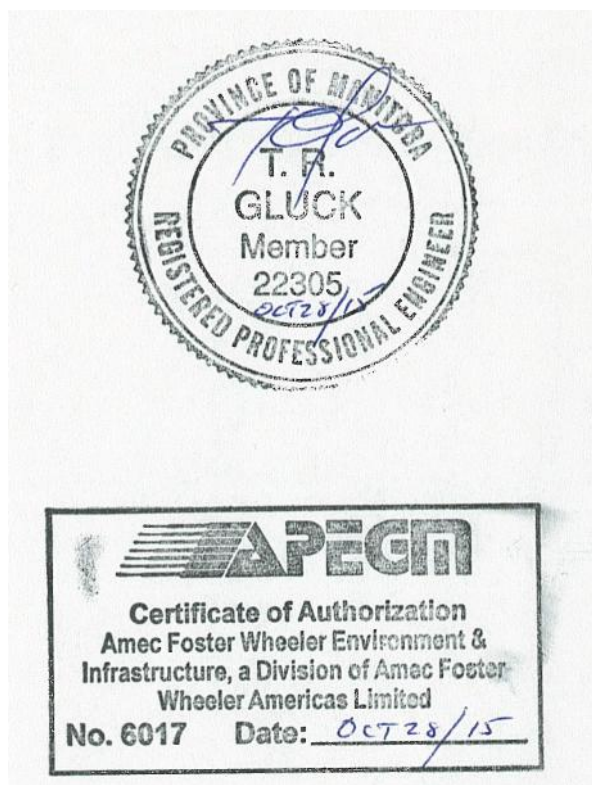

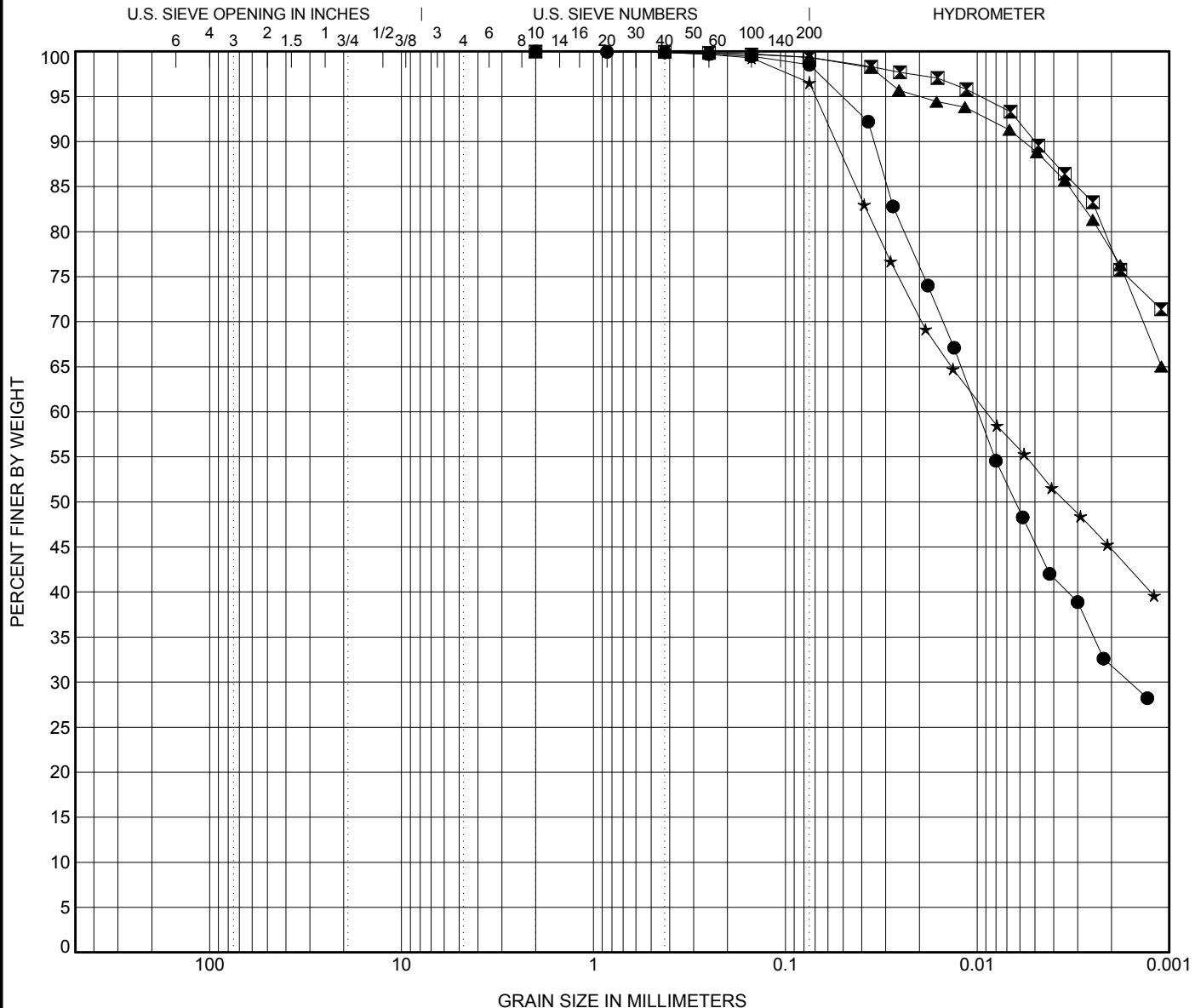

COBBLES	GRAVEL		SAND			SILT / CLAY
	coarse	fine	coarse	medium	fine	

Sample ID	Depth	MC	LL	PL	PI	D100	D60	D30	D10	%Gravel	%Sand	%Silt	%Clay
● TH02	1.2 m	30.0	41	15	26	2	0.01	0.002		0.0	1.5	66.7	31.8
▣ TH05	0.4 m	36.9	97	27	70	2				0.0	0.7	21.2	78.2
▲ TH05	3.2 m	46.9	89	20	69	2				0.0	0.6	21.5	77.9
★ TH12	0.3 m	28.6	61	18	43	2	0.009			0.0	3.5	51.7	44.8

WX11334.1400.GPJ 15/10/28 12:41 PM (WPG - GRAIN SIZE WITH ATTERBERG & MC)

Amec Foster Wheeler 440 Dovercourt Drive Winnipeg, Mb - R3Y 1N4 PHONE: 204-488-2997 FAX: 204-489-8261		CLIENT LOGO:	CLIENT:
		J R Cousin Consultants Ltd.	
PROJECT:	Altona Landfill	PER:	DATE:
TITLE:	PARTICLE SIZE DISTRIBUTION, ATTERBERG LIMIT & MOISTURE CONTENT	SIGNATURE:	October 28, 2015
		PROJECTION:	PROJECT No.:
		N/A	WX11334.1400
		AS SHOWN	FIGURE No.:
			1

ASTM D5084 - HYDRAULIC CONDUCTIVITY REPORT



TO: Oswald Wohlgemut, M.Sc
JR Cousin Consultants Ltd
91 Scurfield Boulevard
Winnipeg, MB R3Y 1G4

PROJECT NO: WX11334 - 1400
CLIENT: JR Cousin Consultants Ltd
DATE SUBMITTED: 30-Sep-15

PROJECT: Altona Landfill

TEST HOLE: TH05
SAMPLE NO.: 2
SAMPLE DEPTH: 4.5-5.1m

PERMEANT: De-Aired Tap Water
HYDRAULIC GRADIENT: 29.01

CONSTANT HEAD METHOD ($K = cQL/thA$)

	Sample Height, L (cm)	Sample Dia. (cm)	Water Content (%)	Dry Density (kg/m ³)	Degree of Saturation (%)	Cell Pressure (kPa)	Back Pressure (kPa)	Differential Pressure, h (kPa)
Initial	7.27	7.26	45.7%	1214	99.4%	241.4	196.5	20.7
Final	7.28	7.25	47.4%	1200	100.9%			

Date & Time		Time, t (seconds)	Flow (Q)		Temp. Corr, c	Hyd. Cond. Corrected, K (cm/s)
Start	End		Influent (ml)	Effluent (ml)		
10/14/15 7:18 AM	10/15/15 7:23 AM	86700	2.15	2.10	1.238	2.52E-08
10/15/15 7:23 AM	10/16/15 7:24 AM	86460	2.00	2.00	0.980	1.89E-08
10/16/15 7:24 AM	10/19/15 7:10 AM	258360	5.00	5.10	0.980	1.59E-08
10/19/15 7:10 AM	10/20/15 7:24 AM	87240	1.55	1.60	0.980	1.47E-08

Soil Description: CLAY - silty, high plastic, moist, firm (pp=0.9), greyish brown

Average Temperature
Corrected Value (cm/s): 1.87E-08

Amec Foster Wheeler Environment & Infrastructure

Per: 
Brad Wiebe, M.Sc., P.Eng.
Associate Geotechnical Engineer

*Reporting of these results constitutes a testing service only.
Engineering interpretation or evaluation of the test results is provided only on written request.*

11 December 2015

Project No. WX11334-1400



J.R. Cousin Consultants Ltd.

91 Scurfield Boulevard
Winnipeg, Manitoba
R3Y 1G4

Attention: **Mr. Oswald Wohlgemut**

**Re: Soils Analysis
Altona Landfill**

1.0 INTRODUCTION

As authorized by Mr. Oswald Wohlgemut of J.R. Cousin Consultants Ltd. (JRCC), Amec Foster Wheeler Environment and Infrastructure, a division of Amec Foster Wheeler Americas Ltd. (Amec Foster Wheeler), has completed an evaluation of 2 samples (referred to as 1 grab and 1 bucket sample that) were submitted to our office by JRCC. Visual classification, Atterberg limits, particle size and moisture content testing were requested for the grab sample with a Proctor and remoulded hydraulic conductivity test for the bucket sample. Comments relating to suitability of the soils to be used as a cell liner were also requested.

2.0 LABORATORY TESTING

On receipt, the grab sample was visually classified in accordance with the Modified Unified Soil Classification System and tested for moisture content, particle size (hydrometer method) and Atterberg limits. The visual classification and laboratory testing results are summarized in Table 1 with the laboratory data summary also appended to this report.

Table 1: Lab Results

Sample Number	Depth (m)	Water Content (%)	Atterberg Limits			Particle Size Analysis			
			Liquid Limit (%)	Plastic Limit (%)	Plasticity Index	% Gravel	% Sand	% Silt	% Clay
TH04	0.2 – 0.7	30.7	68	16	52	0	3.3	35.2	61.4
Classification: CH – Clay, silty, trace sand, high plastic, moist									

Note: Sample information provided by JRCC

A standard Proctor test and a remolded hydraulic conductivity test were undertaken on the bucket sample from TH12 (0.3 to 0.8m) as per JRCC and the. Results were as follows:

Standard Proctor – 1444 kg/m³ @ 27.0% OMC

Hydraulic Conductivity – 1.83 x 10⁻⁹ cm/sec – compacted at 95.8% SPMDD;

3.0 DISCUSSION

Amec Foster Wheeler was requested to comment on the suitability of the soils for use as a remoulded liner, based on the visual assessment and the test results summarized above. Feasibility for the utilization of the various materials as an impermeable liner for the proposed lagoon will largely depend on the quality and amount of the clay available. Typical engineering practice is to specify materials that comply with the following minimum parameters:

- Liquid Limit of 30% or greater ;
- Plastic Index of 10% or greater;
- 30% or more passing a number 200 mesh sieve; and
- 20% or more of clay particles (2-µm particle size)

In general, materials meeting the combination of characteristics noted above would provide a liner having a hydraulic conductivity not exceeding 1×10^{-7} cm/sec. Based on the laboratory test data for the grab sample noted above it would be expected to meet the above general criteria. The hydraulic conductivity test completed on the remoulded sample further suggests suitability in meeting the requirement of a maximum of 1×10^{-7} cm/sec.

4.0 CLOSURE

Amec Foster Wheeler trusts that the forgoing is sufficient for your present requirements. Should you require additional information, please contact the undersigned at this office.

Sincerely,

Amec Foster Wheeler Environment & Infrastructure
A Division of Amec Foster Wheeler Americas Limited

Trevor Gluck, P. Eng.
Senior Geotechnical Engineer

Reviewed By:
Harley Pankratz, P. Eng.
VP; Eastern Prairies/Northern Alberta

Attachments;
Lab Summary (1)
Hydraulic Conductivity Test (1)
Proctor Test (1)

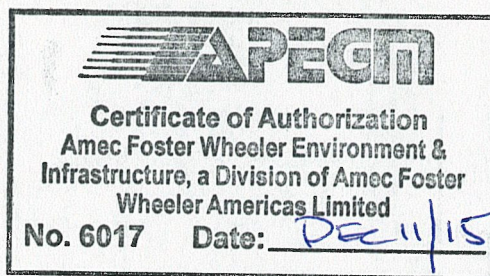
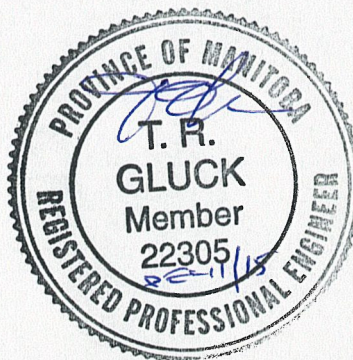

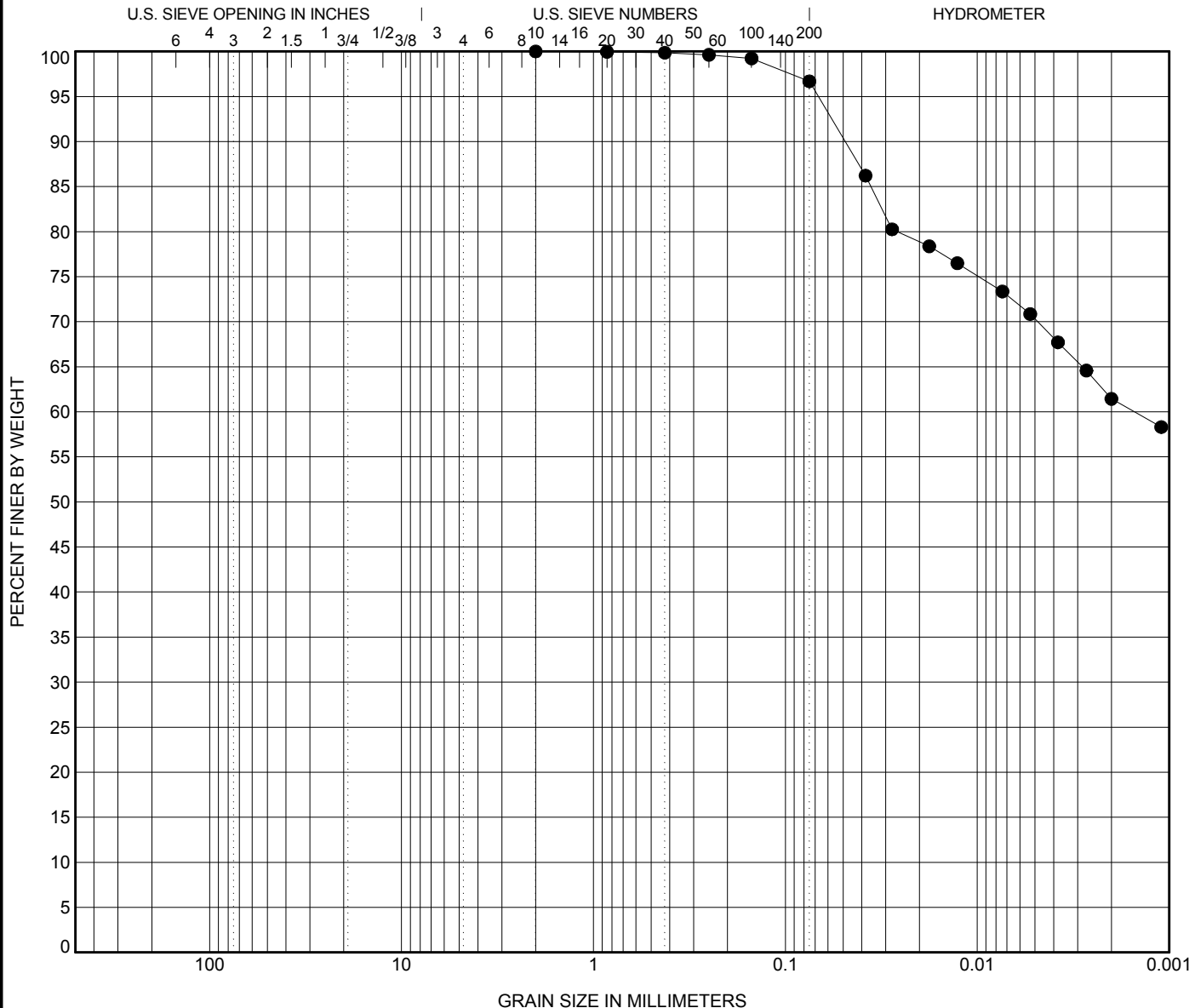

COBBLES	GRAVEL		SAND			SILT / CLAY
	coarse	fine	coarse	medium	fine	

Sample ID	Depth	MC	LL	PL	PI	D100	D60	D30	D10	%Gravel	%Sand	%Silt	%Clay
● TH04	0.2 m	30.7	68	16	52	2	0.002			0.0	3.3	35.2	61.4

WX11334.1400.GPJ 15/12/11 09:41 AM (WPG - GRAIN SIZE WITH ATTERBERG & MC)

Amec Foster Wheeler 440 Dovercourt Drive Winnipeg, Mb - R3Y 1N4 PHONE: 204-488-2997 FAX: 204-489-8261		CLIENT LOGO:	CLIENT:
		J R Cousin Consultants Ltd.	
PROJECT:	Altona Landfill	PER:	DATE:
TITLE:	PARTICLE SIZE DISTRIBUTION, ATTERBERG LIMIT & MOISTURE CONTENT	SIGNATURE:	December 11, 2015
		PROJECTION:	PROJECT No.:
		N/A	WX11334.1400
		SCALE:	FIGURE No.:
		AS SHOWN	1

Moisture / Density Relationship



Report Date: December 11, 2015

Client
Name: JR Cousin Consultants
Address: 91A Scurfield Blvd Winnipeg, MB R3Y 1G4
Attention: David Kelly
PO Number:
Sample Date: 8/27/2015 by Client
Source: TH12 @ 0.3-0.6m

Project
Name: (WX11334) Various Projects 2015
Address: Winnipeg, Manitoba
Phase: **Task:**
Manager: Trevor Gluck
Lab/Ref. #: WX11334.1400
Description: Clay

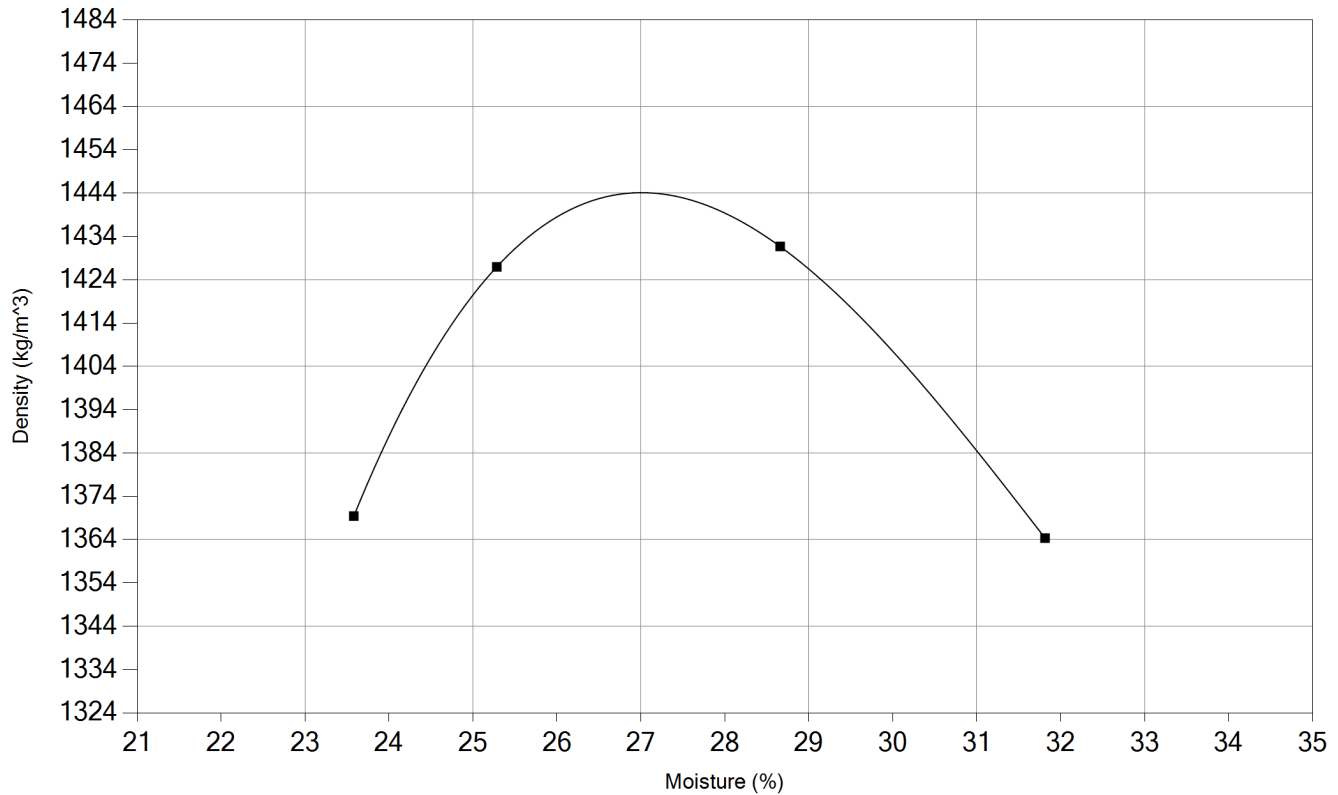

Moisture Density Relationship: (ASTM D698-07) Method: A

Preparation Method: Dry **Rammer Type:** Mechanical

Maximum Density (kg/m³): 1444

Optimum Moisture (%): 27.0

Remarks:

Distribution: AmecFosterWheeler-Admin

Reviewed By: Trevor Gluck

Amec Foster Wheeler Environment & Infrastructure - 440 Dovercourt Drive - Winnipeg, MB - R3Y 1N4 Canada

Phone: (204) 488 2997 Fax: (204) 489 8261

CCIL CCIL Certified Aggregate Type C & Type D

ASTM D5084 - HYDRAULIC CONDUCTIVITY REPORT



TO: Oswald Wohlgemut, M.Sc
JR Cousin Consultants Ltd
91 Scurfield Boulevard
Winnipeg, MB R3Y 1G4

PROJECT NO: WX11334 - 1400
CLIENT: JR Cousin Consultants Ltd
DATE SUBMITTED: 02-Nov-15

PROJECT: Altona Landfill

TEST HOLE: TH12
SAMPLE NO.: 1
SAMPLE DEPTH: 0.3-0.8m

PERMEANT: De-Aired Tap Water
HYDRAULIC GRADIENT: 29.28

CONSTANT HEAD METHOD ($K = cQL/thA$)

	Sample Height, L (cm)	Sample Dia. (cm)	Water Content (%)	Dry Density (kg/m ³)	Degree of Saturation (%)	Cell Pressure (kPa)	Back Pressure (kPa)	Differential Pressure, h (kPa)
Initial	7.20	7.18	31.1%	1384	86.7%	241.4	196.5	20.7
Final	7.16	7.15	37.1%	1365	100.5%			

Date & Time		Time, t (seconds)	Flow (Q)		Temp. Corr, c	Hyd. Cond. Corrected, K (cm/s)
Start	End		Influent (ml)	Effluent (ml)		
11/25/15 7:25 AM	11/27/15 7:28 AM	172980	0.40	0.40	1.225	2.39E-09
11/27/15 7:28 AM	11/30/15 7:25 AM	259020	0.60	0.60	0.956	1.87E-09
11/30/15 7:25 AM	12/2/15 7:20 AM	172500	0.40	0.40	0.956	1.87E-09
12/2/15 7:20 AM	12/4/15 7:25 AM	173100	0.40	0.40	0.956	1.86E-09
12/4/15 7:25 AM	12/7/15 7:15 AM	258600	0.55	0.55	0.956	1.71E-09
12/7/15 7:15 AM	12/9/15 7:15 AM	172800	0.40	0.40	0.956	1.87E-09
12/9/15 7:15 AM	12/10/15 7:10 AM	86100	0.20	0.20	0.956	1.87E-09

Soil Description: CLAY - silty, trace sand, high plastic, moist,
stiff (pp=1.25), dark grey

Standard Proctor Maximum Dry Density: 1444 kg/m³
Optimum Moisture Content (OMC): 27 %
Percent of SPMDD Achieved: 95.84 %

Average Temperature
Corrected Value (cm/s): 1.83E-09

Amec Foster Wheeler Environment & Infrastructure

Per: 
Brad Wiebe, M.Sc., P.Eng.
Associate Geotechnical Engineer

*Reporting of these results constitutes a testing service only.
Engineering interpretation or evaluation of the test results is provided only on written request.*

ALS Test Results, August 31, 2015



J.R. Cousin Consultants
ATTN: OSWALD WOHLGEMUT
91A Scurfield Boulevard
Winnipeg MB R3Y 1G4

Date Received: 31-AUG-15
Report Date: 17-SEP-15 09:29 (MT)
Version: FINAL

Client Phone: 204-489-0474

Certificate of Analysis

Lab Work Order #: L1665450
Project P.O. #: NOT SUBMITTED
Job Reference:
C of C Numbers:
Legal Site Desc:

Hua Wo
Chemistry Laboratory Manager

[This report shall not be reproduced except in full without the written authority of the Laboratory.]

ADDRESS: 1329 Niakwa Road East, Unit 12, Winnipeg, MB R2J 3T4 Canada | Phone: +1 204 255 9720 | Fax: +1 204 255 9721
ALS CANADA LTD Part of the ALS Group A Campbell Brothers Limited Company

ALS ENVIRONMENTAL ANALYTICAL REPORT

Sample Details/Parameters	Result	Qualifier*	D.L.	Units	Extracted	Analyzed	Batch
L1665450-1 MW1							
Sampled By: oswald w on 28-AUG-15 @ 16:30							
Matrix: groundwater							
BTEX							
BTX plus F1 by GCMS							
Benzene	<0.00050		0.00050	mg/L		11-SEP-15	R3264397
Toluene	<0.0010		0.0010	mg/L		11-SEP-15	R3264397
Ethyl benzene	<0.00050		0.00050	mg/L		11-SEP-15	R3264397
o-Xylene	<0.00050		0.00050	mg/L		11-SEP-15	R3264397
m+p-Xylenes	<0.00050		0.00050	mg/L		11-SEP-15	R3264397
F1 (C6-C10)	<0.10		0.10	mg/L		11-SEP-15	R3264397
Surrogate: 4-Bromofluorobenzene (SS)	86.7		70-130	%		11-SEP-15	R3264397
CCME Total Hydrocarbons							
F1-BTEX	<0.10		0.10	mg/L		14-SEP-15	
Sum of Xylene Isomer Concentrations							
Xylenes (Total)	<0.0015		0.0015	mg/L		14-SEP-15	
Single Metal in Water by ICPMS (Total)							
Total Metals by ICP-MS							
Arsenic (As)-Total	0.0613	DLM	0.0020	mg/L	02-SEP-15	02-SEP-15	R3258905
Miscellaneous Parameters							
Ammonia, Total (as N)	0.087		0.010	mg/L		09-SEP-15	R3263295
Biochemical Oxygen Demand	2.6		2.0	mg/L		31-AUG-15	R3262375
Chemical Oxygen Demand	167		20	mg/L		02-SEP-15	R3259194
Dissolved Organic Carbon	6.9		1.0	mg/L		03-SEP-15	R3261037
Oxygen, Dissolved	3.70		0.10	mg/L		01-SEP-15	R3258679
Mercury (Hg)-Dissolved	<0.000020		0.000020	mg/L	09-SEP-15	09-SEP-15	R3264033
Phosphorus (P)-Total	4.18		0.20	mg/L		03-SEP-15	R3259378
Total Dissolved Solids	3890		6.0	mg/L		03-SEP-15	R3264136
Total Kjeldahl Nitrogen	2.46		0.20	mg/L	14-SEP-15	15-SEP-15	R3266298
Routine Dissolved + Metal scan							
Alkalinity, Bicarbonate							
Bicarbonate (HCO3)	440		1.2	mg/L		11-SEP-15	
Alkalinity, Carbonate							
Carbonate (CO3)	<0.60		0.60	mg/L		11-SEP-15	
Alkalinity, Hydroxide							
Hydroxide (OH)	<0.34		0.34	mg/L		11-SEP-15	
Chloride in Water by IC							
Chloride (Cl)	71		10	mg/L		31-AUG-15	R3257847
Conductivity							
Conductivity	3780		1.0	umhos/cm		09-SEP-15	R3264333
Dissolved Metals by ICP-MS							
Barium (Ba)-Dissolved	0.0157		0.00020	mg/L	01-SEP-15	01-SEP-15	R3258009
Boron (B)-Dissolved	0.240		0.010	mg/L	01-SEP-15	01-SEP-15	R3258009
Cadmium (Cd)-Dissolved	0.000167		0.000010	mg/L	01-SEP-15	01-SEP-15	R3258009
Calcium (Ca)-Dissolved	508		5.0	mg/L	01-SEP-15	03-SEP-15	R3259743
Chromium (Cr)-Dissolved	<0.0010		0.0010	mg/L	01-SEP-15	01-SEP-15	R3258009
Copper (Cu)-Dissolved	0.00309		0.00020	mg/L	01-SEP-15	01-SEP-15	R3258009
Iron (Fe)-Dissolved	<0.10		0.10	mg/L	01-SEP-15	01-SEP-15	R3258009
Lead (Pb)-Dissolved	0.000123		0.000090	mg/L	01-SEP-15	01-SEP-15	R3258009
Magnesium (Mg)-Dissolved	301		0.010	mg/L	01-SEP-15	01-SEP-15	R3258009
Manganese (Mn)-Dissolved	0.0204		0.00010	mg/L	01-SEP-15	01-SEP-15	R3258009
Potassium (K)-Dissolved	7.58		0.020	mg/L	01-SEP-15	01-SEP-15	R3258009
Silicon (Si)-Dissolved	12.6		0.10	mg/L	01-SEP-15	01-SEP-15	R3258009
Sodium (Na)-Dissolved	148		0.020	mg/L	01-SEP-15	01-SEP-15	R3258009
Uranium (U)-Dissolved	0.118		0.00010	mg/L	01-SEP-15	01-SEP-15	R3258009

* Refer to Referenced Information for Qualifiers (if any) and Methodology.

ALS ENVIRONMENTAL ANALYTICAL REPORT

Sample Details/Parameters	Result	Qualifier*	D.L.	Units	Extracted	Analyzed	Batch
L1665450-1 MW1 Sampled By: oswald w on 28-AUG-15 @ 16:30 Matrix: groundwater							
Dissolved Metals by ICP-MS							
Zinc (Zn)-Dissolved	0.0044		0.0020	mg/L	01-SEP-15	01-SEP-15	R3258009
Hardness Calculated							
Hardness (as CaCO3)	2510		0.20	mg/L		04-SEP-15	
Nitrate in Water by IC							
Nitrate (as N)	0.50		0.40	mg/L		31-AUG-15	R3257847
Nitrate+Nitrite							
Nitrate and Nitrite as N	0.50		0.45	mg/L		01-SEP-15	
Nitrite in Water by IC							
Nitrite (as N)	<0.20	DLM	0.20	mg/L		31-AUG-15	R3257847
Sulfate in Water by IC							
Sulfate (SO4)	2350		6.0	mg/L		31-AUG-15	R3257847
TDS calculated							
TDS (Calculated)	3610		5.0	mg/L		11-SEP-15	
Total Alkalinity as CaCO3							
Alkalinity, Total (as CaCO3)	360		1.0	mg/L		09-SEP-15	R3264333
pH							
pH	7.87		0.10	pH units		09-SEP-15	R3264333
L1665450-2 MW2 Sampled By: oswald w on 28-AUG-15 @ 16:15 Matrix: groundwater							
BTEX							
BTX plus F1 by GCMS							
Benzene	<0.00050		0.00050	mg/L		11-SEP-15	R3264397
Toluene	<0.0010		0.0010	mg/L		11-SEP-15	R3264397
Ethyl benzene	<0.00050		0.00050	mg/L		11-SEP-15	R3264397
o-Xylene	<0.00050		0.00050	mg/L		11-SEP-15	R3264397
m+p-Xylenes	<0.00050		0.00050	mg/L		11-SEP-15	R3264397
F1 (C6-C10)	<0.10		0.10	mg/L		11-SEP-15	R3264397
Surrogate: 4-Bromofluorobenzene (SS)	88.7		70-130	%		11-SEP-15	R3264397
CCME Total Hydrocarbons							
F1-BTEX	<0.10		0.10	mg/L		14-SEP-15	
Sum of Xylene Isomer Concentrations							
Xylenes (Total)	<0.0015		0.0015	mg/L		14-SEP-15	
Single Metal in Water by ICPMS (Total)							
Total Metals by ICP-MS							
Arsenic (As)-Total	0.0335	DLM	0.0020	mg/L	02-SEP-15	02-SEP-15	R3258905
Miscellaneous Parameters							
Ammonia, Total (as N)	0.363		0.010	mg/L		09-SEP-15	R3263295
Biochemical Oxygen Demand	6.9		2.0	mg/L		31-AUG-15	R3262375
Chemical Oxygen Demand	279		20	mg/L		02-SEP-15	R3259194
Dissolved Organic Carbon	69.7	DLA	5.0	mg/L		03-SEP-15	R3261037
Oxygen, Dissolved	1.90	RWHS	0.10	mg/L		01-SEP-15	R3258679
Mercury (Hg)-Dissolved	<0.000020		0.000020	mg/L	09-SEP-15	09-SEP-15	R3264033
Phosphorus (P)-Total	4.38		0.20	mg/L		03-SEP-15	R3259378
Total Dissolved Solids	12900		24	mg/L		03-SEP-15	R3264136
Total Kjeldahl Nitrogen	5.6		2.0	mg/L	11-SEP-15	11-SEP-15	R3264415
Routine Dissolved + Metal scan							
Alkalinity, Bicarbonate							
Bicarbonate (HCO3)	885		1.2	mg/L		11-SEP-15	
Alkalinity, Carbonate							
Carbonate (CO3)	<0.60		0.60	mg/L		11-SEP-15	

* Refer to Referenced Information for Qualifiers (if any) and Methodology.

ALS ENVIRONMENTAL ANALYTICAL REPORT

Sample Details/Parameters	Result	Qualifier*	D.L.	Units	Extracted	Analyzed	Batch
L1665450-2 MW2							
Sampled By: oswald w on 28-AUG-15 @ 16:15							
Matrix: groundwater							
Alkalinity, Hydroxide							
Hydroxide (OH)	<0.34		0.34	mg/L		11-SEP-15	
Chloride in Water by IC							
Chloride (Cl)	705		25	mg/L		31-AUG-15	R3257847
Conductivity							
Conductivity	>12900		1.0	umhos/cm		09-SEP-15	R3264333
Dissolved Metals by ICP-MS							
Barium (Ba)-Dissolved	0.0476		0.00020	mg/L	01-SEP-15	01-SEP-15	R3258009
Boron (B)-Dissolved	0.404		0.010	mg/L	01-SEP-15	01-SEP-15	R3258009
Cadmium (Cd)-Dissolved	0.000156		0.000010	mg/L	01-SEP-15	01-SEP-15	R3258009
Calcium (Ca)-Dissolved	621		5.0	mg/L	01-SEP-15	03-SEP-15	R3259743
Chromium (Cr)-Dissolved	<0.0010		0.0010	mg/L	01-SEP-15	01-SEP-15	R3258009
Copper (Cu)-Dissolved	0.0134		0.00020	mg/L	01-SEP-15	01-SEP-15	R3258009
Iron (Fe)-Dissolved	0.16		0.10	mg/L	01-SEP-15	01-SEP-15	R3258009
Lead (Pb)-Dissolved	0.000152		0.000090	mg/L	01-SEP-15	01-SEP-15	R3258009
Magnesium (Mg)-Dissolved	1550		1.0	mg/L	01-SEP-15	03-SEP-15	R3259743
Manganese (Mn)-Dissolved	0.0909		0.00010	mg/L	01-SEP-15	01-SEP-15	R3258009
Potassium (K)-Dissolved	27.9		0.020	mg/L	01-SEP-15	01-SEP-15	R3258009
Silicon (Si)-Dissolved	16.6		0.10	mg/L	01-SEP-15	01-SEP-15	R3258009
Sodium (Na)-Dissolved	2290		2.0	mg/L	01-SEP-15	03-SEP-15	R3259743
Uranium (U)-Dissolved	0.920		0.00010	mg/L	01-SEP-15	01-SEP-15	R3258009
Zinc (Zn)-Dissolved	0.0076		0.0020	mg/L	01-SEP-15	01-SEP-15	R3258009
Hardness Calculated							
Hardness (as CaCO3)	7910		0.20	mg/L		04-SEP-15	
Nitrate in Water by IC							
Nitrate (as N)	<1.0	DLM	1.0	mg/L		31-AUG-15	R3257847
Nitrate+Nitrite							
Nitrate and Nitrite as N	<1.1		1.1	mg/L		01-SEP-15	
Nitrite in Water by IC							
Nitrite (as N)	<0.50	DLM	0.50	mg/L		31-AUG-15	R3257847
Sulfate in Water by IC							
Sulfate (SO4)	10800		15	mg/L		31-AUG-15	R3257847
TDS calculated							
TDS (Calculated)	16400		5.0	mg/L		11-SEP-15	
Total Alkalinity as CaCO3							
Alkalinity, Total (as CaCO3)	726		1.0	mg/L		09-SEP-15	R3264333
pH							
pH	7.96		0.10	pH units		09-SEP-15	R3264333
L1665450-3 MW3							
Sampled By: oswald w on 28-AUG-15 @ 16:00							
Matrix: groundwater							
BTEX							
BTX plus F1 by GCMS							
Benzene	0.00244		0.00050	mg/L		11-SEP-15	R3264397
Toluene	<0.0010		0.0010	mg/L		11-SEP-15	R3264397
Ethyl benzene	<0.00050		0.00050	mg/L		11-SEP-15	R3264397
o-Xylene	<0.00050		0.00050	mg/L		11-SEP-15	R3264397
m+p-Xylenes	<0.00050		0.00050	mg/L		11-SEP-15	R3264397
F1 (C6-C10)	<0.10		0.10	mg/L		11-SEP-15	R3264397
Surrogate: 4-Bromofluorobenzene (SS)	85.5		70-130	%		11-SEP-15	R3264397
CCME Total Hydrocarbons							
F1-BTEX	<0.10		0.10	mg/L		14-SEP-15	
Sum of Xylene Isomer Concentrations							

* Refer to Referenced Information for Qualifiers (if any) and Methodology.

ALS ENVIRONMENTAL ANALYTICAL REPORT

Sample Details/Parameters	Result	Qualifier*	D.L.	Units	Extracted	Analyzed	Batch
L1665450-3 MW3							
Sampled By: oswald w on 28-AUG-15 @ 16:00							
Matrix: groundwater							
Sum of Xylene Isomer Concentrations							
Xylenes (Total)	<0.0015		0.0015	mg/L		14-SEP-15	
Single Metal in Water by ICPMS (Total)							
Total Metals by ICP-MS							
Arsenic (As)-Total	0.0465	DLM	0.0020	mg/L	02-SEP-15	02-SEP-15	R3258905
Miscellaneous Parameters							
Ammonia, Total (as N)	0.163		0.010	mg/L		09-SEP-15	R3263295
Biochemical Oxygen Demand	30.2	DLA	6.0	mg/L		31-AUG-15	R3262375
Chemical Oxygen Demand	731		20	mg/L		02-SEP-15	R3259194
Dissolved Organic Carbon	253	DLA	20	mg/L		03-SEP-15	R3261037
Oxygen, Dissolved	0.10	RWHS	0.10	mg/L		01-SEP-15	R3258679
Mercury (Hg)-Dissolved	0.000030	RRV	0.000020	mg/L	09-SEP-15	15-SEP-15	R3266586
Phosphorus (P)-Total	1.42		0.20	mg/L		03-SEP-15	R3259378
Total Dissolved Solids	6980		6.0	mg/L		03-SEP-15	R3264136
Total Kjeldahl Nitrogen	1.20		0.20	mg/L	11-SEP-15	11-SEP-15	R3264415
Routine Dissolved + Metal scan							
Alkalinity, Bicarbonate							
Bicarbonate (HCO3)	1950		1.2	mg/L		11-SEP-15	
Alkalinity, Carbonate							
Carbonate (CO3)	<0.60		0.60	mg/L		11-SEP-15	
Alkalinity, Hydroxide							
Hydroxide (OH)	<0.34		0.34	mg/L		11-SEP-15	
Chloride in Water by IC							
Chloride (Cl)	531		25	mg/L		31-AUG-15	R3257847
Conductivity							
Conductivity	7810		1.0	umhos/cm		09-SEP-15	R3264333
Dissolved Metals by ICP-MS							
Barium (Ba)-Dissolved	0.0474		0.00020	mg/L	01-SEP-15	01-SEP-15	R3258009
Boron (B)-Dissolved	0.882		0.010	mg/L	01-SEP-15	01-SEP-15	R3258009
Cadmium (Cd)-Dissolved	0.00171		0.000010	mg/L	01-SEP-15	01-SEP-15	R3258009
Calcium (Ca)-Dissolved	633		5.0	mg/L	01-SEP-15	03-SEP-15	R3259743
Chromium (Cr)-Dissolved	0.0030		0.0010	mg/L	01-SEP-15	01-SEP-15	R3258009
Copper (Cu)-Dissolved	0.0353		0.00020	mg/L	01-SEP-15	01-SEP-15	R3258009
Iron (Fe)-Dissolved	2.51		0.10	mg/L	01-SEP-15	01-SEP-15	R3258009
Lead (Pb)-Dissolved	0.00378		0.000090	mg/L	01-SEP-15	01-SEP-15	R3258009
Magnesium (Mg)-Dissolved	423		0.010	mg/L	01-SEP-15	01-SEP-15	R3258009
Manganese (Mn)-Dissolved	10.5		0.010	mg/L	01-SEP-15	03-SEP-15	R3259743
Potassium (K)-Dissolved	9.76		0.020	mg/L	01-SEP-15	01-SEP-15	R3258009
Silicon (Si)-Dissolved	22.7		0.10	mg/L	01-SEP-15	01-SEP-15	R3258009
Sodium (Na)-Dissolved	1070		2.0	mg/L	01-SEP-15	03-SEP-15	R3259743
Uranium (U)-Dissolved	0.188		0.00010	mg/L	01-SEP-15	01-SEP-15	R3258009
Zinc (Zn)-Dissolved	0.0233		0.0020	mg/L	01-SEP-15	01-SEP-15	R3258009
Hardness Calculated							
Hardness (as CaCO3)	3320		0.20	mg/L		04-SEP-15	
Nitrate in Water by IC							
Nitrate (as N)	<1.0	DLM	1.0	mg/L		31-AUG-15	R3257847
Nitrate+Nitrite							
Nitrate and Nitrite as N	<1.1		1.1	mg/L		01-SEP-15	
Nitrite in Water by IC							
Nitrite (as N)	<0.50	DLM	0.50	mg/L		31-AUG-15	R3257847
Sulfate in Water by IC							
Sulfate (SO4)	3260		15	mg/L		31-AUG-15	R3257847

* Refer to Referenced Information for Qualifiers (if any) and Methodology.

Reference Information

Qualifiers for Individual Samples Listed:

Sample Number	Client ID	Qualifier	Description
L1665450-1	MW1	WSMD	Water sample(s) for dissolved mercury analysis was not submitted in glass or PTFE container with HCl preservative. Results may be biased low.
L1665450-2	MW2	WSMD	Water sample(s) for dissolved mercury analysis was not submitted in glass or PTFE container with HCl preservative. Results may be biased low.
L1665450-3	MW3	WSMD	Water sample(s) for dissolved mercury analysis was not submitted in glass or PTFE container with HCl preservative. Results may be biased low.

Sample Parameter Qualifier Key:

Qualifier	Description
DLA	Detection Limit adjusted for required dilution
DLM	Detection Limit Adjusted due to sample matrix effects.
MS-B	Matrix Spike recovery could not be accurately calculated due to high analyte background in sample.
RRV	Reported Result Verified By Repeat Analysis
RWHS	Samples Received With Headspace

Test Method References:

ALS Test Code	Matrix	Test Description	Method Reference**
ALK-CO3CO3-CALC-WP	Water	Alkalinity, Carbonate	CALCULATION
The Alkalinity of water is a measure of its acid neutralizing capacity. Alkalinity is imparted by bicarbonate, carbonate and hydroxide components of water. The fraction of alkalinity contributed by carbonate is calculated and reported as mg CO ₃ ²⁻ /L.			
ALK-HCO3HCO3-CALC-WP	Water	Alkalinity, Bicarbonate	CALCULATION
The Alkalinity of water is a measure of its acid neutralizing capacity. Alkalinity is imparted by bicarbonate, carbonate and hydroxide components of water. The fraction of alkalinity contributed by bicarbonate is calculated and reported as mg HCO ₃ ⁻ /L.			
ALK-OHOH-CALC-WP	Water	Alkalinity, Hydroxide	CALCULATION
The Alkalinity of water is a measure of its acid neutralizing capacity. Alkalinity is imparted by bicarbonate, carbonate and hydroxide components of water. The fraction of alkalinity contributed by hydroxide is calculated and reported as mg OH ⁻ /L.			
ALK-TITR-WP	Water	Total Alkalinity as CaCO ₃	APHA 2320B
The Alkalinity of water is a measure of its acid neutralizing capacity. Alkalinity is imparted by bicarbonate, carbonate and hydroxide components of water. Total alkalinity is determined by titration with a strong standard mineral acid to the successive HCO ₃ ⁻ and H ₂ CO ₃ endpoints indicated electrometrically.			
BOD-WP	Water	Biochemical Oxygen Demand (BOD)	APHA 5210 B
Samples are diluted and seeded and then incubated in airtight bottles at 20°C for 5 days. Dissolved oxygen is measured initially and after incubation, and results are computed from the difference between initial and final DO.			
BTEXS+F1-HSMS-WP	Water	BTX plus F1 by GCMS	EPA 8260C / EPA 5021A
The water sample, with added reagents, is heated in a sealed vial to equilibrium. The headspace from the vial is transferred into a gas chromatograph. Target compound concentrations are measured using mass spectrometry detection.			
C-DIS-ORG-WT	Water	Dissolved Organic Carbon	APHA 5310 B-INSTRUMENTAL
Sample is filtered through a 0.45µm filter, sample is then injected into a heated reaction chamber which is packed with an oxidative catalyst. The water is vaporized and the organic carbon is oxidized to carbon dioxide. The carbon dioxide is transported in a carrier gas and is measured by a non-dispersive infrared detector.			
CL-IC-N-WP	Water	Chloride in Water by IC	EPA 300.1 (mod)
Inorganic anions are analyzed by Ion Chromatography with conductivity and/or UV detection.			
COD-WP	Water	Chemical Oxygen Demand	APHA 5220 D
The Chemical Oxygen Demand (COD) test is used to estimate the amount of organic matter in the water. The sample is added to HACH brand COD tubes, which contain a premixed volume of reagents. The sample is then heated for two hours on the COD reactor with a strong oxidizing agent, potassium dichromate. The COD reagents also contain silver and mercury ions. Silver is used as a catalyst and mercury is used to complex chloride interference. Oxidizable organic compounds react, reducing the dichromate ion to green chromic ion.			

For the 10 - 150 mg/L range the remaining Cr⁶⁺ is measured colorimetrically and a decrease in absorbance at 420 nm is proportional to the COD. For the 100 - 1500 mg/L range the amount of Cr³⁺ produced is measured colorimetrically and an increase in absorbance at 620 nm is proportional to the COD. Samples with concentrations > 1500 mg/L can be diluted into either linear range.

Reference Information

Test Method References:

ALS Test Code	Matrix	Test Description	Method Reference**
EC-WP	Water	Conductivity	APHA 2510B
Conductivity of an aqueous solution refers to its ability to carry an electric current. Conductance of a solution is measured between two spatially fixed and chemically inert electrodes.			
ETL-HARDNESS-DIS-WP	Water	Hardness Calculated	HARDNESS CALCULATED
ETL-SOLIDS-CALC-WP	Water	TDS calculated	CALCULATION
F1-F4-CALC-WP	Water	CCME Total Hydrocarbons	CCME CWS-PHC, Pub #1310, Dec 2001-L
Analytical methods used for analysis of CCME Petroleum Hydrocarbons have been validated and comply with the Reference Method for the CWS PHC.			
In cases where results for both F4 and F4G are reported, the greater of the two results must be used in any application of the CWS PHC guidelines and the gravimetric heavy hydrocarbons cannot be added to the C6 to C50 hydrocarbons.			
In samples where BTEX and F1 were analyzed , F1-BTEX represents a value where the sum of Benzene, Toluene, Ethylbenzene and total Xylenes has been subtracted from F1.			
In samples where PAHs, F2 and F3 were analyzed, F2-Naphth represents the result where Naphthalene has been subtracted from F2. F3-PAH represents a result where the sum of Benzo(a)anthracene, Benzo(a)pyrene, Benzo(b)fluoranthene, Benzo(k)fluoranthene, Dibenzo(a,h)anthracene, Fluoranthene, Indeno(1,2,3-cd)pyrene, Phenanthrene, and Pyrene has been subtracted from F3.			
Unless otherwise qualified, the following quality control criteria have been met for the F1 hydrocarbon range:			
1. All extraction and analysis holding times were met.			
2. Instrument performance showing response factors for C6 and C10 within 30% of the response factor for toluene.			
3. Linearity of gasoline response within 15% throughout the calibration range.			
Unless otherwise qualified, the following quality control criteria have been met for the F2-F4 hydrocarbon ranges:			
1. All extraction and analysis holding times were met.			
2. Instrument performance showing C10, C16 and C34 response factors within 10% of their average.			
3. Instrument performance showing the C50 response factor within 30% of the average of the C10, C16 and C34 response factors.			
4. Linearity of diesel or motor oil response within 15% throughout the calibration range.			
HG-D-CVAF-WP	Water	Mercury Dissolved	EPA245.7 V2.0
Mercury in filtered and unfiltered waters is oxidized with Bromine monochloride and analyzed by cold-vapour atomic fluorescence spectrometry.			
IONBALANCE-CALC-WP	Water	Ion Balance Calculation	APHA 1030E
MET-D-L-MS-WP	Water	Dissolved Metals by ICP-MS	APHA 3030B/EPA 6020A -DL
This analysis involves filtration (APHA 3030B) and analysis by inductively coupled plasma - mass spectrometry (EPA Method 6020A).			
MET-T-L-MS-WP	Water	Total Metals by ICP-MS	APHA 3030E/EPA 6020A-TL
This analysis involves preliminary sample treatment by hotblock acid digestion (APHA 3030E). Instrumental analysis is by inductively coupled plasma - mass spectrometry (EPA Method 6020A).			
N-TOTKJ-WP	Water	Total Kjeldahl Nitrogen	Quickchem method 10-107-06-2-E Lachat
Samples are digested with a sulphuric acid solution, cooled, diluted with water, and analyzed for ammonia. Total Kjeldahl nitrogen is the sum of free-ammonia and organic nitrogen compounds which are converted to ammonium sulphate through this digestion process. Analysis is performed by Flow Injection Analysis (FIA). The pH of the digested sample is raised to a known, basic pH by neutralization with a concentrated buffer solution. This neutralization converts the ammonium cation to ammonia. The ammonia produced is heated with salicylate and hypochlorite to produce blue colour which is proportional to the ammonia concentration.			
NH3-COL-WP	Water	Ammonia by colour	APHA 4500 NH3 F
Ammonia in water samples forms indophenol when reacted with hypochlorite and phenol. The intensity is amplified by the addition of sodium nitroprusside and measured colourmetrically.			
NO2+NO3-CALC-WP	Water	Nitrate+Nitrite	CALCULATION
NO2-IC-N-WP	Water	Nitrite in Water by IC	EPA 300.1 (mod)
Inorganic anions are analyzed by Ion Chromatography with conductivity and/or UV detection.			
NO3-IC-N-WP	Water	Nitrate in Water by IC	EPA 300.1 (mod)

Reference Information

Test Method References:

ALS Test Code	Matrix	Test Description	Method Reference**
Inorganic anions are analyzed by Ion Chromatography with conductivity and/or UV detection.			
O2-DIS-WP	Water	Dissolved Oxygen	APHA 4500-O-C
Manganous sulphate reacts with potassium or sodium hydroxide to give a white precipitate of manganous hydroxide. In the presence of oxygen, brown manganic hydroxide is formed. Addition of sulfuric acid dissolves the manganic hydroxide, yielding manganic sulfate which reacts with iodide, releasing iodide in an amount equivalent to the original DO content. The iodide is then titrated with a standard solution of thiosulphate.			
P-T-COL-WP	Water	Phosphorus, Total	APHA 4500 P PHOSPHORUS
This analysis is carried out using procedures adapted from APHA Method 4500-P "Phosphorus". Total Phosphorus is determined colourimetrically after persulphate digestion of the sample.			
PH-WP	Water	pH	APHA 4500H
The pH of a sample is the determination of the activity of the hydrogen ions by potentiometric measurement using a standard hydrogen electrode and a reference electrode.			
SO4-IC-N-WP	Water	Sulfate in Water by IC	EPA 300.1 (mod)
Inorganic anions are analyzed by Ion Chromatography with conductivity and/or UV detection.			
TDS-WP	Water	Total Dissolved Solids (TDS)	APHA 2540 SOLIDS C,E
A well-mixed sample is filtered through a glass fiber filter paper. The filtrate is then evaporated to dryness in a pre-weighed vial and dried at 180 – 2C. The increase in vial weight represents the total dissolved solids.			
XYLENES-SUM-CALC-WP	Water	Sum of Xylene Isomer Concentrations	CALCULATED RESULT
Total xylenes represents the sum of o-xylene and m&p-xylene.			

** ALS test methods may incorporate modifications from specified reference methods to improve performance.

The last two letters of the above test code(s) indicate the laboratory that performed analytical analysis for that test. Refer to the list below:

Laboratory Definition Code	Laboratory Location
WP	ALS ENVIRONMENTAL - WINNIPEG, MANITOBA, CANADA

Chain of Custody Numbers:

GLOSSARY OF REPORT TERMS

Surrogates are compounds that are similar in behaviour to target analyte(s), but that do not normally occur in environmental samples. For applicable tests, surrogates are added to samples prior to analysis as a check on recovery. In reports that display the D.L. column, laboratory objectives for surrogates are listed there.

mg/kg - milligrams per kilogram based on dry weight of sample

mg/kg wwt - milligrams per kilogram based on wet weight of sample

mg/kg lwt - milligrams per kilogram based on lipid-adjusted weight

mg/L - unit of concentration based on volume, parts per million.

< - Less than.

D.L. - The reporting limit.

N/A - Result not available. Refer to qualifier code and definition for explanation.

Test results reported relate only to the samples as received by the laboratory.

UNLESS OTHERWISE STATED, ALL SAMPLES WERE RECEIVED IN ACCEPTABLE CONDITION.

Analytical results in unsigned test reports with the DRAFT watermark are subject to change, pending final QC review.



Quality Control Report

Workorder: L1665450

Report Date: 17-SEP-15

Page 1 of 9

Client: J.R. Cousin Consultants
 91A Scurfield Boulevard
 Winnipeg MB R3Y 1G4

Contact: OSWALD WOHLGEMUT

Test	Matrix	Reference	Result	Qualifier	Units	RPD	Limit	Analyzed
ALK-TITR-WP		Water						
Batch	R3264333							
WG2167976-10	DUP	L1665851-7						
Alkalinity, Total (as CaCO3)		358	354		mg/L	1.2	20	09-SEP-15
WG2167976-9	LCS							
Alkalinity, Total (as CaCO3)			101.1		%		85-115	09-SEP-15
WG2167976-6	MB							
Alkalinity, Total (as CaCO3)			<1.0		mg/L		1	09-SEP-15
BOD-WP		Water						
Batch	R3262375							
WG2161201-5	DUP	L1665433-1						
Biochemical Oxygen Demand		2210	2280		mg/L	3.3	20	31-AUG-15
WG2161201-2	IRM	61-GG						
Biochemical Oxygen Demand			103.4		%		85-115	31-AUG-15
WG2161201-1	MB							
Biochemical Oxygen Demand			<2.0		mg/L		2	31-AUG-15
BTEXS+F1-HSMS-WP		Water						
Batch	R3264397							
WG2165708-4	DUP	L1667118-2						
Benzene		12.8	12.4		mg/L	3.0	30	11-SEP-15
Toluene		6.75	6.85		mg/L	1.5	30	11-SEP-15
Ethyl benzene		1.10	1.10		mg/L	0.2	30	11-SEP-15
o-Xylene		0.621	0.608		mg/L	2.1	30	11-SEP-15
m+p-Xylenes		3.24	3.23		mg/L	0.1	30	11-SEP-15
F1 (C6-C10)		36.5	28.0		mg/L	26	30	11-SEP-15
WG2165708-2	LCS							
Benzene			83.7		%		70-130	10-SEP-15
Toluene			81.4		%		70-130	10-SEP-15
Ethyl benzene			81.9		%		70-130	10-SEP-15
o-Xylene			83.0		%		70-130	10-SEP-15
m+p-Xylenes			88.0		%		70-130	10-SEP-15
WG2165708-3	LCS							
F1 (C6-C10)			86.8		%		70-130	10-SEP-15
WG2165708-1	MB							
Benzene			<0.00050		mg/L		0.0005	10-SEP-15
Toluene			<0.0010		mg/L		0.001	10-SEP-15
Ethyl benzene			<0.00050		mg/L		0.0005	10-SEP-15
o-Xylene			<0.00050		mg/L		0.0005	10-SEP-15



Quality Control Report

Workorder: L1665450

Report Date: 17-SEP-15

Page 2 of 9

Client: J.R. Cousin Consultants
91A Scurfield Boulevard
Winnipeg MB R3Y 1G4

Contact: OSWALD WOHLGEMUT

Test	Matrix	Reference	Result	Qualifier	Units	RPD	Limit	Analyzed
BTEXS+F1-HSMS-WP Water								
Batch R3264397								
WG2165708-1	MB							
m+p-Xylenes			<0.00050		mg/L		0.0005	10-SEP-15
F1 (C6-C10)			<0.10		mg/L		0.1	10-SEP-15
Surrogate: 4-Bromofluorobenzene (SS)			98.0		%		70-130	10-SEP-15
C-DIS-ORG-WT Water								
Batch R3261037								
WG2163426-3	DUP	L1666407-2						
Dissolved Organic Carbon		2.6	2.8		mg/L	10	20	03-SEP-15
WG2163426-2	LCS							
Dissolved Organic Carbon			106.7		%		80-120	03-SEP-15
WG2163426-1	MB							
Dissolved Organic Carbon			<1.0		mg/L		1	03-SEP-15
WG2163426-4	MS	L1666407-2						
Dissolved Organic Carbon			99.4		%		70-130	03-SEP-15
CL-IC-N-WP Water								
Batch R3257847								
WG2161278-7	DUP	L1665376-2						
Chloride (Cl)		<0.50	<0.50	RPD-NA	mg/L	N/A	20	31-AUG-15
WG2161278-6	LCS							
Chloride (Cl)			100.7		%		90-110	31-AUG-15
WG2161278-5	MB							
Chloride (Cl)			<0.50		mg/L		0.5	31-AUG-15
WG2161278-8	MS	L1665376-2						
Chloride (Cl)			108.7		%		75-125	31-AUG-15
COD-WP Water								
Batch R3259194								
WG2163718-3	DUP	L1666051-1						
Chemical Oxygen Demand		49	50		mg/L	2.9	20	02-SEP-15
WG2163718-2	LCS							
Chemical Oxygen Demand			99.3		%		85-115	02-SEP-15
WG2163718-1	MB							
Chemical Oxygen Demand			<20		mg/L		20	02-SEP-15
WG2163718-4	MS	L1666051-1						
Chemical Oxygen Demand			99.5		%		75-125	02-SEP-15
EC-WP Water								



Quality Control Report

Workorder: L1665450

Report Date: 17-SEP-15

Page 3 of 9

Client: J.R. Cousin Consultants
 91A Scurfield Boulevard
 Winnipeg MB R3Y 1G4

Contact: OSWALD WOHLGEMUT

Test	Matrix	Reference	Result	Qualifier	Units	RPD	Limit	Analyzed
EC-WP		Water						
Batch	R3264333							
WG2167976-10	DUP	L1665851-7						
Conductivity		819	821		umhos/cm	0.2	10	09-SEP-15
WG2167976-8	LCS							
Conductivity			95.3		%		90-110	09-SEP-15
WG2167976-6	MB							
Conductivity			<1.0		umhos/cm		1	09-SEP-15
HG-D-CVAF-WP		Water						
Batch	R3264033							
WG2168130-2	DUP	L1666765-1						
Mercury (Hg)-Dissolved		<0.000020	<0.000020	RPD-NA	mg/L	N/A	20	09-SEP-15
WG2168521-1	LCS							
Mercury (Hg)-Dissolved			88.2		%		80-120	09-SEP-15
WG2168130-1	MB							
Mercury (Hg)-Dissolved			<0.000020		mg/L		0.00002	09-SEP-15
WG2168130-3	MS	L1666765-2						
Mercury (Hg)-Dissolved			102.8		%		70-130	09-SEP-15
MET-D-L-MS-WP		Water						
Batch	R3258009							
WG2162477-10	DUP	WG2162477-9						
Barium (Ba)-Dissolved		0.0398	0.0395		mg/L	0.8	20	01-SEP-15
Boron (B)-Dissolved		0.015	0.015		mg/L	0.0	20	01-SEP-15
Cadmium (Cd)-Dissolved		0.000010	0.000011		mg/L	13	20	01-SEP-15
Chromium (Cr)-Dissolved		<0.0010	<0.0010	RPD-NA	mg/L	N/A	20	01-SEP-15
Copper (Cu)-Dissolved		0.00281	0.00267		mg/L	5.2	20	01-SEP-15
Iron (Fe)-Dissolved		1.61	1.49		mg/L	7.6	20	01-SEP-15
Lead (Pb)-Dissolved		0.000097	0.000112		mg/L	14	20	01-SEP-15
Magnesium (Mg)-Dissolved		24.7	23.0		mg/L	7.0	20	01-SEP-15
Manganese (Mn)-Dissolved		0.946	0.894		mg/L	5.6	20	01-SEP-15
Potassium (K)-Dissolved		4.32	4.07		mg/L	6.0	20	01-SEP-15
Silicon (Si)-Dissolved		7.82	7.35		mg/L	6.3	20	01-SEP-15
Sodium (Na)-Dissolved		39.5	37.2		mg/L	6.0	20	01-SEP-15
Uranium (U)-Dissolved		0.00067	0.00068		mg/L	1.9	20	01-SEP-15
Zinc (Zn)-Dissolved		<0.0020	<0.0020	RPD-NA	mg/L	N/A	20	01-SEP-15
WG2162477-8	LCS							
Barium (Ba)-Dissolved			101.8		%		80-120	01-SEP-15
Boron (B)-Dissolved			98.3		%		80-120	01-SEP-15



Quality Control Report

Workorder: L1665450

Report Date: 17-SEP-15

Page 4 of 9

Client: J.R. Cousin Consultants
 91A Scurfield Boulevard
 Winnipeg MB R3Y 1G4
 Contact: OSWALD WOHLGEMUT

Test	Matrix	Reference	Result	Qualifier	Units	RPD	Limit	Analyzed
MET-D-L-MS-WP								
	Water							
Batch	R3258009							
WG2162477-8	LCS							
Cadmium (Cd)-Dissolved			103.6		%		80-120	01-SEP-15
Chromium (Cr)-Dissolved			103.1		%		80-120	01-SEP-15
Copper (Cu)-Dissolved			99.4		%		80-120	01-SEP-15
Iron (Fe)-Dissolved			97.6		%		80-120	01-SEP-15
Lead (Pb)-Dissolved			101.6		%		80-120	01-SEP-15
Magnesium (Mg)-Dissolved			105.4		%		80-120	01-SEP-15
Manganese (Mn)-Dissolved			101.6		%		80-120	01-SEP-15
Potassium (K)-Dissolved			104.7		%		80-120	01-SEP-15
Silicon (Si)-Dissolved			107.7		%		80-120	01-SEP-15
Sodium (Na)-Dissolved			104.9		%		80-120	01-SEP-15
Uranium (U)-Dissolved			103.6		%		80-120	01-SEP-15
Zinc (Zn)-Dissolved			99.1		%		80-120	01-SEP-15
WG2162477-7	MB							
Barium (Ba)-Dissolved			<0.00020		mg/L		0.0002	01-SEP-15
Boron (B)-Dissolved			<0.010		mg/L		0.01	01-SEP-15
Cadmium (Cd)-Dissolved			<0.000010		mg/L		0.00001	01-SEP-15
Chromium (Cr)-Dissolved			<0.0010		mg/L		0.001	01-SEP-15
Copper (Cu)-Dissolved			<0.00020		mg/L		0.0002	01-SEP-15
Iron (Fe)-Dissolved			<0.10		mg/L		0.1	01-SEP-15
Lead (Pb)-Dissolved			<0.000090		mg/L		0.00009	01-SEP-15
Magnesium (Mg)-Dissolved			<0.010		mg/L		0.01	01-SEP-15
Manganese (Mn)-Dissolved			<0.00010		mg/L		0.0001	01-SEP-15
Potassium (K)-Dissolved			<0.020		mg/L		0.02	01-SEP-15
Silicon (Si)-Dissolved			<0.10		mg/L		0.1	01-SEP-15
Sodium (Na)-Dissolved			<0.020		mg/L		0.02	01-SEP-15
Uranium (U)-Dissolved			<0.00010		mg/L		0.0001	01-SEP-15
Zinc (Zn)-Dissolved			<0.0020		mg/L		0.002	01-SEP-15
WG2162477-12	MS	WG2162477-11						
Barium (Ba)-Dissolved			N/A	MS-B	%		-	01-SEP-15
Boron (B)-Dissolved			88.5		%		70-130	01-SEP-15
Cadmium (Cd)-Dissolved			101.1		%		70-130	01-SEP-15
Chromium (Cr)-Dissolved			97.4		%		70-130	01-SEP-15
Copper (Cu)-Dissolved			94.9		%		70-130	01-SEP-15
Iron (Fe)-Dissolved			91.0		%		70-130	01-SEP-15



Quality Control Report

Workorder: L1665450

Report Date: 17-SEP-15

Page 5 of 9

Client: J.R. Cousin Consultants
 91A Scurfield Boulevard
 Winnipeg MB R3Y 1G4
 Contact: OSWALD WOHLGEMUT

Test	Matrix	Reference	Result	Qualifier	Units	RPD	Limit	Analyzed
MET-D-L-MS-WP								
	Water							
Batch	R3258009							
WG2162477-12 MS		WG2162477-11						
Lead (Pb)-Dissolved			94.9		%		70-130	01-SEP-15
Magnesium (Mg)-Dissolved			N/A	MS-B	%		-	01-SEP-15
Manganese (Mn)-Dissolved			N/A	MS-B	%		-	01-SEP-15
Potassium (K)-Dissolved			N/A	MS-B	%		-	01-SEP-15
Silicon (Si)-Dissolved			78.3		%		70-130	01-SEP-15
Sodium (Na)-Dissolved			N/A	MS-B	%		-	01-SEP-15
Uranium (U)-Dissolved			101.8		%		70-130	01-SEP-15
Zinc (Zn)-Dissolved			89.1		%		70-130	01-SEP-15
MET-T-L-MS-WP								
	Water							
Batch	R3258905							
WG2162555-4 DUP		WG2162555-3						
Arsenic (As)-Total		0.00383	0.00395		mg/L	3.1	20	02-SEP-15
WG2162555-2 LCS								
Arsenic (As)-Total			103.0		%		80-120	02-SEP-15
WG2162555-1 MB								
Arsenic (As)-Total			<0.00020		mg/L		0.0002	02-SEP-15
WG2162555-6 MS		WG2162555-5						
Arsenic (As)-Total			99.3		%		70-130	02-SEP-15
N-TOTKJ-WP								
	Water							
Batch	R3264415							
WG2168513-3 DUP		L1664850-1						
Total Kjeldahl Nitrogen		0.27	0.24		mg/L	14	20	11-SEP-15
WG2168513-2 LCS								
Total Kjeldahl Nitrogen			97.2		%		75-125	11-SEP-15
WG2168513-1 MB								
Total Kjeldahl Nitrogen			<0.20		mg/L		0.2	11-SEP-15
WG2168513-4 MS		L1664850-1						
Total Kjeldahl Nitrogen			98.9		%		70-130	11-SEP-15
Batch	R3266298							
WG2170033-3 DUP		L1662891-1						
Total Kjeldahl Nitrogen		<0.20	<0.20	RPD-NA	mg/L	N/A	20	15-SEP-15
WG2170033-2 LCS								
Total Kjeldahl Nitrogen			97.2		%		75-125	15-SEP-15
WG2170033-1 MB								
Total Kjeldahl Nitrogen			<0.20		mg/L		0.2	15-SEP-15
WG2170033-4 MS		L1662891-1						



Quality Control Report

Workorder: L1665450

Report Date: 17-SEP-15

Page 6 of 9

Client: J.R. Cousin Consultants
 91A Scurfield Boulevard
 Winnipeg MB R3Y 1G4
 Contact: OSWALD WOHLGEMUT

Test	Matrix	Reference	Result	Qualifier	Units	RPD	Limit	Analyzed
N-TOTKJ-WP								
Water								
Batch	R3266298							
WG2170033-4	MS	L1662891-1						
Total Kjeldahl Nitrogen			110.0		%		70-130	15-SEP-15
NH3-COL-WP								
Water								
Batch	R3263295							
WG2167683-19	DUP	L1666241-5						
Ammonia, Total (as N)		<0.010	<0.010	RPD-NA	mg/L	N/A	20	09-SEP-15
WG2167683-18	LCS		99.5		%		85-115	09-SEP-15
Ammonia, Total (as N)								
WG2167683-17	MB		<0.010		mg/L		0.01	09-SEP-15
Ammonia, Total (as N)								
WG2167683-20	MS	L1666241-5						
Ammonia, Total (as N)			93.4		%		75-125	09-SEP-15
NO2-IC-N-WP								
Water								
Batch	R3257847							
WG2161278-6	LCS							
Nitrite (as N)			99.8		%		90-110	31-AUG-15
WG2161278-5	MB		<0.010		mg/L		0.01	31-AUG-15
Nitrite (as N)								
NO3-IC-N-WP								
Water								
Batch	R3257847							
WG2161278-6	LCS							
Nitrate (as N)			101.3		%		90-110	31-AUG-15
WG2161278-5	MB		<0.020		mg/L		0.02	31-AUG-15
Nitrate (as N)								
O2-DIS-WP								
Water								
Batch	R3258679							
WG2162993-2	LCS							
Oxygen, Dissolved			101.2		%		85-115	01-SEP-15
WG2162993-1	MB		<0.10		mg/L		0.1	01-SEP-15
Oxygen, Dissolved								
P-T-COL-WP								
Water								
Batch	R3259378							
WG2163390-15	DUP	L1665289-3						
Phosphorus (P)-Total		0.068	0.066		mg/L	2.4	20	03-SEP-15
WG2163390-19	DUP	L1665830-3						
Phosphorus (P)-Total		0.296	0.299		mg/L	1.0	20	03-SEP-15



Quality Control Report

Workorder: L1665450

Report Date: 17-SEP-15

Page 7 of 9

Client: J.R. Cousin Consultants
 91A Scurfield Boulevard
 Winnipeg MB R3Y 1G4
 Contact: OSWALD WOHLGEMUT

Test	Matrix	Reference	Result	Qualifier	Units	RPD	Limit	Analyzed
P-T-COL-WP								
	Water							
Batch	R3259378							
WG2163390-14	LCS							
Phosphorus (P)-Total			96.2		%		80-120	03-SEP-15
WG2163390-18	LCS							
Phosphorus (P)-Total			96.2		%		80-120	03-SEP-15
WG2163390-13	MB							
Phosphorus (P)-Total			<0.010		mg/L		0.01	03-SEP-15
WG2163390-17	MB							
Phosphorus (P)-Total			<0.010		mg/L		0.01	03-SEP-15
WG2163390-16	MS	L1665289-4						
Phosphorus (P)-Total			N/A	MS-B	%		-	03-SEP-15
WG2163390-20	MS	L1665891-1						
Phosphorus (P)-Total			98.0		%		70-130	03-SEP-15
PH-WP								
	Water							
Batch	R3264333							
WG2167976-10	DUP	L1665851-7						
pH		7.95	8.00	J	pH units	0.05	0.2	09-SEP-15
WG2167976-7	LCS							
pH			7.42		pH units		7.3-7.5	09-SEP-15
SO4-IC-N-WP								
	Water							
Batch	R3257847							
WG2161278-7	DUP	L1665376-2						
Sulfate (SO4)		85.5	85.7		mg/L	0.3	20	31-AUG-15
WG2161278-6	LCS							
Sulfate (SO4)			101.2		%		90-110	31-AUG-15
WG2161278-5	MB							
Sulfate (SO4)			<0.30		mg/L		0.3	31-AUG-15
WG2161278-8	MS	L1665376-2						
Sulfate (SO4)			97.6		%		75-125	31-AUG-15
TDS-WP								
	Water							
Batch	R3264136							
WG2164766-4	DUP	L1664982-1						
Total Dissolved Solids		98.0	97.7		mg/L	0.3	20	03-SEP-15
WG2164766-2	LCS							
Total Dissolved Solids			97.0		%		85-115	03-SEP-15
WG2164766-1	MB							
Total Dissolved Solids			<3.0		mg/L		3	03-SEP-15

Quality Control Report

Workorder: L1665450

Report Date: 17-SEP-15

Client: J.R. Cousin Consultants
91A Scurfield Boulevard
Winnipeg MB R3Y 1G4
Contact: OSWALD WOHLGEMUT

Page 8 of 9

Legend:

Limit	ALS Control Limit (Data Quality Objectives)
DUP	Duplicate
RPD	Relative Percent Difference
N/A	Not Available
LCS	Laboratory Control Sample
SRM	Standard Reference Material
MS	Matrix Spike
MSD	Matrix Spike Duplicate
ADE	Average Desorption Efficiency
MB	Method Blank
IRM	Internal Reference Material
CRM	Certified Reference Material
CCV	Continuing Calibration Verification
CVS	Calibration Verification Standard
LCSD	Laboratory Control Sample Duplicate

Sample Parameter Qualifier Definitions:

Qualifier	Description
DLA	Detection Limit adjusted for required dilution
J	Duplicate results and limits are expressed in terms of absolute difference.
MS-B	Matrix Spike recovery could not be accurately calculated due to high analyte background in sample.
RPD-NA	Relative Percent Difference Not Available due to result(s) being less than detection limit.

Quality Control Report

Workorder: L1665450

Report Date: 17-SEP-15

Client: J.R. Cousin Consultants
91A Scurfield Boulevard
Winnipeg MB R3Y 1G4
Contact: OSWALD WOHLGEMUT

Page 9 of 9

Hold Time Exceedances:

ALS Product Description	Sample ID	Sampling Date	Date Processed	Rec. HT	Actual HT	Units	Qualifier
Physical Tests							
Dissolved Oxygen	1	28-AUG-15 16:30	01-SEP-15 16:34	8.0	96	hours	EHTR
	2	28-AUG-15 16:15	01-SEP-15 16:34	8.0	96	hours	EHTR
	3	28-AUG-15 16:00	01-SEP-15 16:34	8.0	96	hours	EHTR
pH	1	28-AUG-15 16:30	09-SEP-15 13:54	0.25	285	hours	EHTR-FM
	2	28-AUG-15 16:15	09-SEP-15 13:54	0.25	286	hours	EHTR-FM
	3	28-AUG-15 16:00	09-SEP-15 13:54	0.25	286	hours	EHTR-FM
Anions and Nutrients							
Nitrate in Water by IC	1	28-AUG-15 16:30	31-AUG-15 16:48	48	72	hours	EHTR
	2	28-AUG-15 16:15	31-AUG-15 16:48	48	72	hours	EHTR
	3	28-AUG-15 16:00	31-AUG-15 16:48	48	73	hours	EHTR
Nitrite in Water by IC	1	28-AUG-15 16:30	31-AUG-15 16:48	48	72	hours	EHTR
	2	28-AUG-15 16:15	31-AUG-15 16:48	48	72	hours	EHTR
	3	28-AUG-15 16:00	31-AUG-15 16:48	48	73	hours	EHTR
Aggregate Organics							
Biochemical Oxygen Demand (BOD)	1	28-AUG-15 16:30	31-AUG-15 09:53	48	65	hours	EHTR
	2	28-AUG-15 16:15	31-AUG-15 09:53	48	66	hours	EHTR
	3	28-AUG-15 16:00	31-AUG-15 09:53	48	66	hours	EHTR

Legend & Qualifier Definitions:

EHTR-FM: Exceeded ALS recommended hold time prior to sample receipt. Field Measurement recommended.
EHTR: Exceeded ALS recommended hold time prior to sample receipt.
EHTL: Exceeded ALS recommended hold time prior to analysis. Sample was received less than 24 hours prior to expiry.
EHT: Exceeded ALS recommended hold time prior to analysis.
Rec. HT: ALS recommended hold time (see units).

Notes*:
Where actual sampling date is not provided to ALS, the date (& time) of receipt is used for calculation purposes.
Where actual sampling time is not provided to ALS, the earlier of 12 noon on the sampling date or the time (& date) of receipt is used for calculation purposes. Samples for L1665450 were received on 31-AUG-15 09:30.

ALS recommended hold times may vary by province. They are assigned to meet known provincial and/or federal government requirements. In the absence of regulatory hold times, ALS establishes recommendations based on guidelines published by the US EPA, APHA Standard Methods, or Environment Canada (where available). For more information, please contact ALS.

The ALS Quality Control Report is provided to ALS clients upon request. ALS includes comprehensive QC checks with every analysis to ensure our high standards of quality are met. Each QC result has a known or expected target value, which is compared against pre-determined data quality objectives to provide confidence in the accuracy of associated test results.

Please note that this report may contain QC results from anonymous Sample Duplicates and Matrix Spikes that do not originate from this Work Order.

Appendix D

Title Page

Plan 1: Site Location Plan with Required Setbacks

Plan 2: Waste Disposal Ground Expansion Site with Test hole Location Plan

Plan 3: Proposed Waste Disposal Ground Expansion Layout and Drainage Plan

Plan 4: Dike, Liner, Leachate Pipe and Manhole Details

Plan 5: Road, Ditch, Fence, Silt Fence, Compost Pad and Sign Details

Plan 6: Site Operations Plan

TOWN OF ALTONA

WASTE DISPOSAL GROUND EXPANSION EAP

PRELIMINARY
NOT FOR CONSTRUCTION

PLAN INDEX

PLAN 1.	SITE LOCATION PLAN WITH REQUIRED SETBACKS
PLAN 2.	WASTE DISPOSAL GROUND SITE WITH TESTHOLE LOCATION PLAN
PLAN 3.	PROPOSED WASTE DISPOSAL GROUND EXPANSION LAYOUT AND DRAINAGE PLAN
PLAN 4.	DIKE LINER, LEACHATE PIPE AND LIFT STATION DETAILS
PLAN 5.	ROAD, DITCH, FENCE, SILT FENCE, COMPOST PAD AND SIGN DETAILS
PLAN 6.	SITE OPERATIONS PLAN

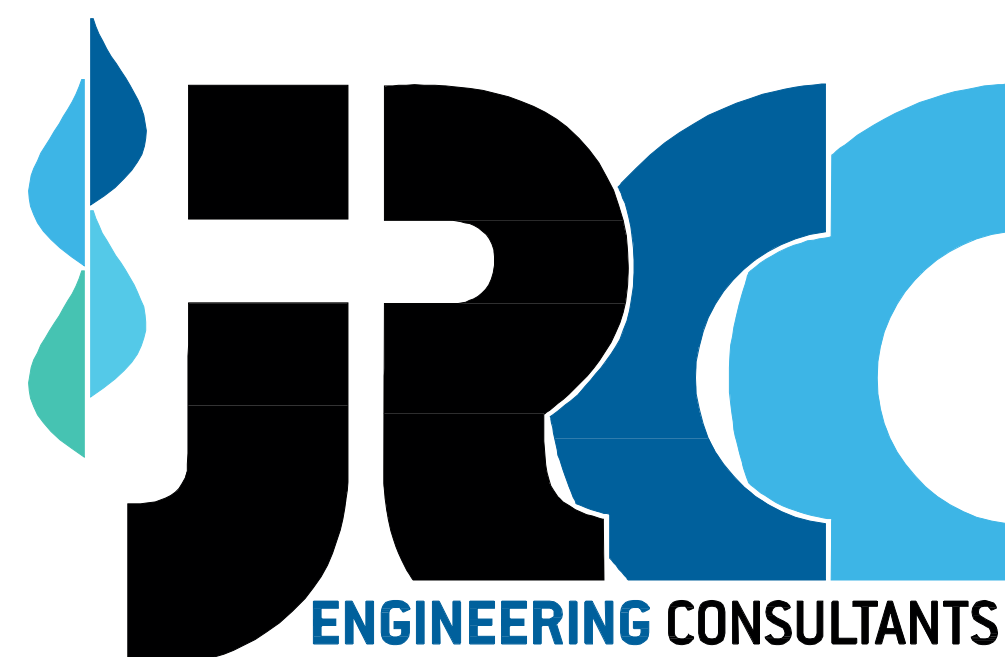

JR Cousin Consultants Ltd.

91A Scurfield Blvd. Winnipeg MB R3Y 1G4

p. (204) 489-0474

f. (204) 489-0487

www.jrcc.ca

ENGINEERING EXCELLENCE SINCE 1981

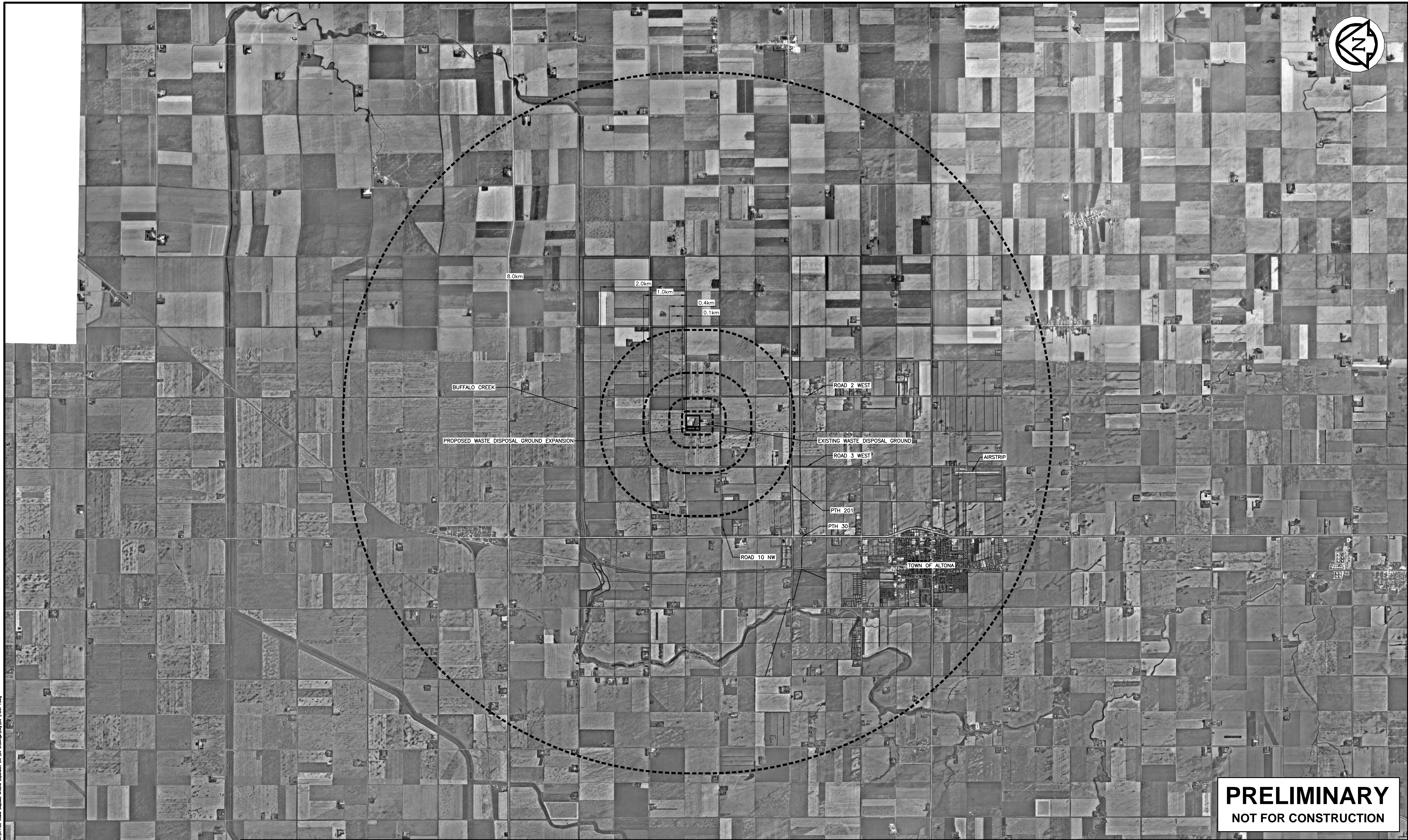
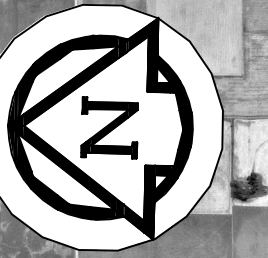

PRELIMINARY
NOT FOR CONSTRUCTION

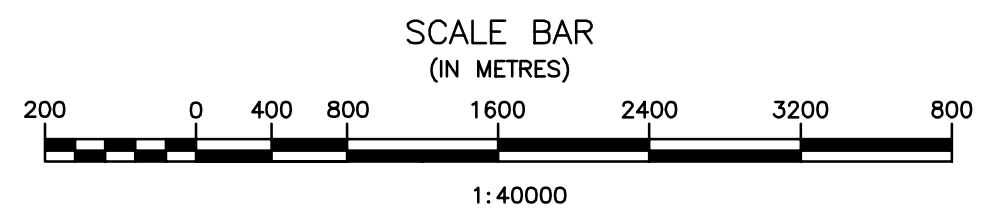

No.	REVISIONS	DATE	INITIALS

B.M. EL.

LOCATIONS OF UNDERGROUND STRUCTURES/UTILITIES AS SHOWN ARE BASED ON AVAILABLE INFORMATION BUT NO GUARANTEE IS GIVEN OR IMPLIED THAT ALL EXISTING UNDERGROUND STRUCTURES/UTILITIES ARE SHOWN OR THAT THE GIVEN LOCATIONS ARE EXACT. CONFIRMATION OF EXISTENCE AND EXACT LOCATION OF ALL UNDERGROUND STRUCTURES/UTILITIES MUST BE OBTAINED FROM THE APPROPRIATE AUTHORITY/OWNER, BY THE CONTRACTOR, BEFORE PROCEEDING WITH CONSTRUCTION.

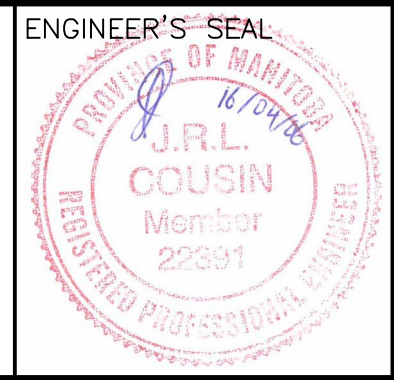

JRC ENGINEERING CONSULTANTS

JR Cousin Consultants Ltd.
91A Scurfield Blvd. Winnipeg MB R3Y 1G4
p. (204) 489-0474
f. (204) 489-0487
www.jrcc.ca

ENGINEERING EXCELLENCE SINCE 1981

CODE: A-677.05	PROJECT: TOWN OF ALTONA WASTE DISPOSAL GROUND EXPANSION EAP
DESIGNED BY: OW	TITLE: SITE LOCATION PLAN WITH REQUIRED SETBACKS
DRAWN BY: RH	SCALE: 1:40000
REVIEWED BY: JRC	DATE: 15/12/17
	PLAN: 1
	SHEET: 1 of 6

Apr 06, 2016 - 9:23am P:\000077 Altona, Town\07720 Waste Disposal Ground Expansion EAP\04 Site Location Plan 1.dwg

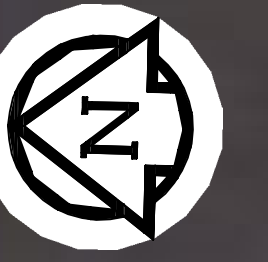

PRELIMINARY
NOT FOR CONSTRUCTION

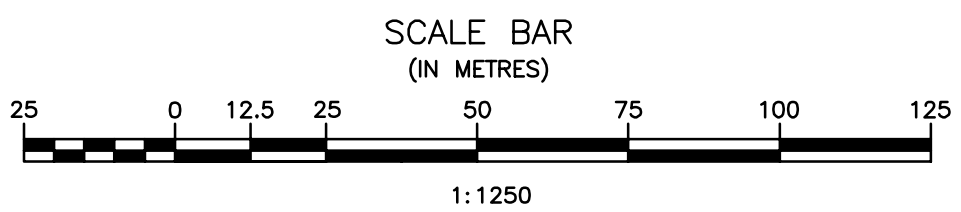

No.	REVISIONS	DATE	INITIALS

B.M. EL.

LOCATIONS OF UNDERGROUND STRUCTURES/UTILITIES AS SHOWN ARE BASED ON AVAILABLE INFORMATION BUT NO GUARANTEE IS GIVEN OR IMPLIED THAT ALL EXISTING UNDERGROUND STRUCTURES/UTILITIES ARE SHOWN OR THAT THE GIVEN LOCATIONS ARE EXACT. CONFIRMATION OF EXISTENCE AND EXACT LOCATION OF ALL UNDERGROUND STRUCTURES/UTILITIES MUST BE OBTAINED FROM THE APPROPRIATE AUTHORITY/OWNER, BY THE CONTRACTOR, BEFORE PROCEEDING WITH CONSTRUCTION.

APEGM
Certificate of Authorization
J.R. Cousin Consultants Ltd.
No. 234 Date: 16/04/06

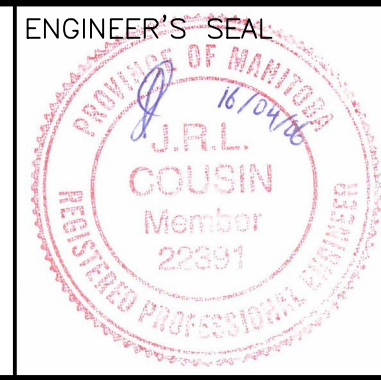

JRC ENGINEERING CONSULTANTS
ENGINEERING EXCELLENCE SINCE 1981

JR Cousin Consultants Ltd.
91A Scurfield Blvd. Winnipeg MB R3Y 1G4
p. (204) 489-0474
f. (204) 489-0487
www.jrcc.ca

CODE: A-677.05	PROJECT: TOWN OF ALTONA WASTE DISPOSAL GROUND EXPANSION EAP
DESIGNED BY: OW	TITLE: WASTE DISPOSAL GROUND SITE WITH TEST HOLE LOCATION PLAN
DRAWN BY: RH	SCALE: 1:1250
REVIEWED BY: JRC	DATE: 15/12/17
	PLAN: 2
	SHEET: 2 of 6

Apr 06, 2016 - 9:50am P:\000077 Altona_Town\07720 Waste Disposal Ground Expansion EAP\04 Drawing\DWG\DWG_Plan 2.dwg

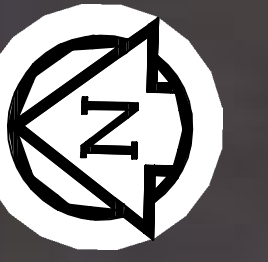

PRELIMINARY
NOT FOR CONSTRUCTION

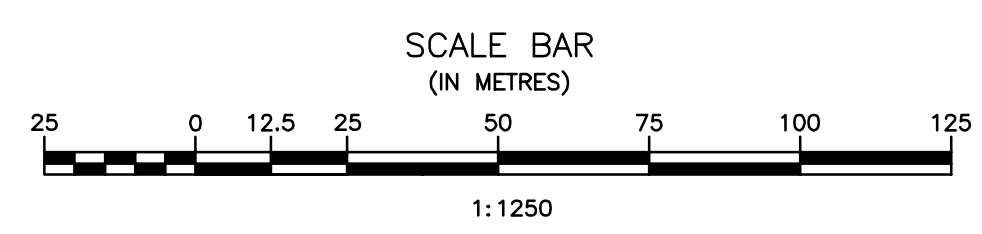

No.	REVISIONS	DATE	INITIALS

B.M. EL.

LOCATIONS OF UNDERGROUND STRUCTURES/UTILITIES AS SHOWN ARE BASED ON AVAILABLE INFORMATION BUT NO GUARANTEE IS GIVEN OR IMPLIED THAT ALL EXISTING UNDERGROUND STRUCTURES/UTILITIES ARE SHOWN OR THAT THE GIVEN LOCATIONS ARE EXACT. CONFIRMATION OF EXISTENCE AND EXACT LOCATION OF ALL UNDERGROUND STRUCTURES/UTILITIES MUST BE OBTAINED FROM THE APPROPRIATE AUTHORITY/OWNER, BY THE CONTRACTOR, BEFORE PROCEEDING WITH CONSTRUCTION.

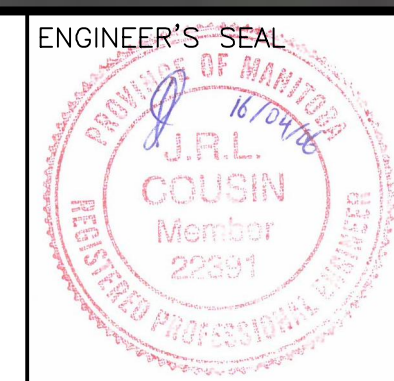
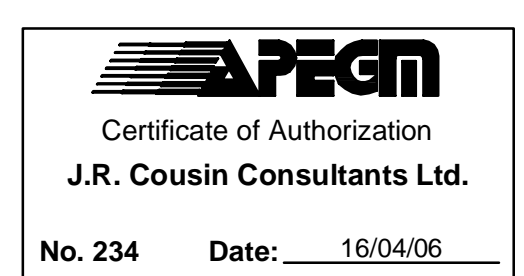







JR Cousin Consultants Ltd.
91A Scurfield Blvd. Winnipeg MB R3Y 1G4
p. (204) 489-0474
f. (204) 489-0487
www.jrcc.ca

ENGINEERING CONSULTANTS
ENGINEERING EXCELLENCE SINCE 1981

CODE: A-677.05	PROJECT: TOWN OF ALTONA WASTE DISPOSAL GROUND EXPANSION EAP
DESIGNED BY: OW	TITLE: PROPOSED WASTE DISPOSAL GROUND EXPANSION LAYOUT AND DRAINAGE PLAN
DRAWN BY: RH	SCALE: 1:1250
REVIEWED BY: JRC	DATE: 15/12/17
	PLAN: 3
	SHEET: 3 of 6

Apr 06, 2016 - 9:45am P:\000077 Altona, Town\17710 Waste Disposal Ground Expansion EAP\04 Drainage\DWG\PLAN 3.dwg

LEGEND:

-  EXCAVATED AND COMPACTED CLAY TYPE SOIL
-  SCARIFIED 150mm AND COMPACTED CLAY TYPE SOIL
-  EXCAVATED AND COMPACTED SOIL MATERIAL
-  EXCAVATED AND COMPACTED MIXTURE OF ORGANIC AND INORGANIC SOILS
-  TOPSOIL
-  INSITU
-  ASPHALT MILLINGS

- LEVEL 1 - PRE-CONSTRUCTION EXISTING PRAIRIE ELEVATION
- LEVEL 2 - ELEVATION FOLLOWING STRIPPED ORGANICS/VEGETATION
- LEVEL 3 - FINISHED CELL BOTTOM ELEVATION
- LEVEL 2 AND 3 - TO BE COMPACTED WITH SHEEPSFOOT PACKER
- LEVEL 4 - BOTTOM OF LINER

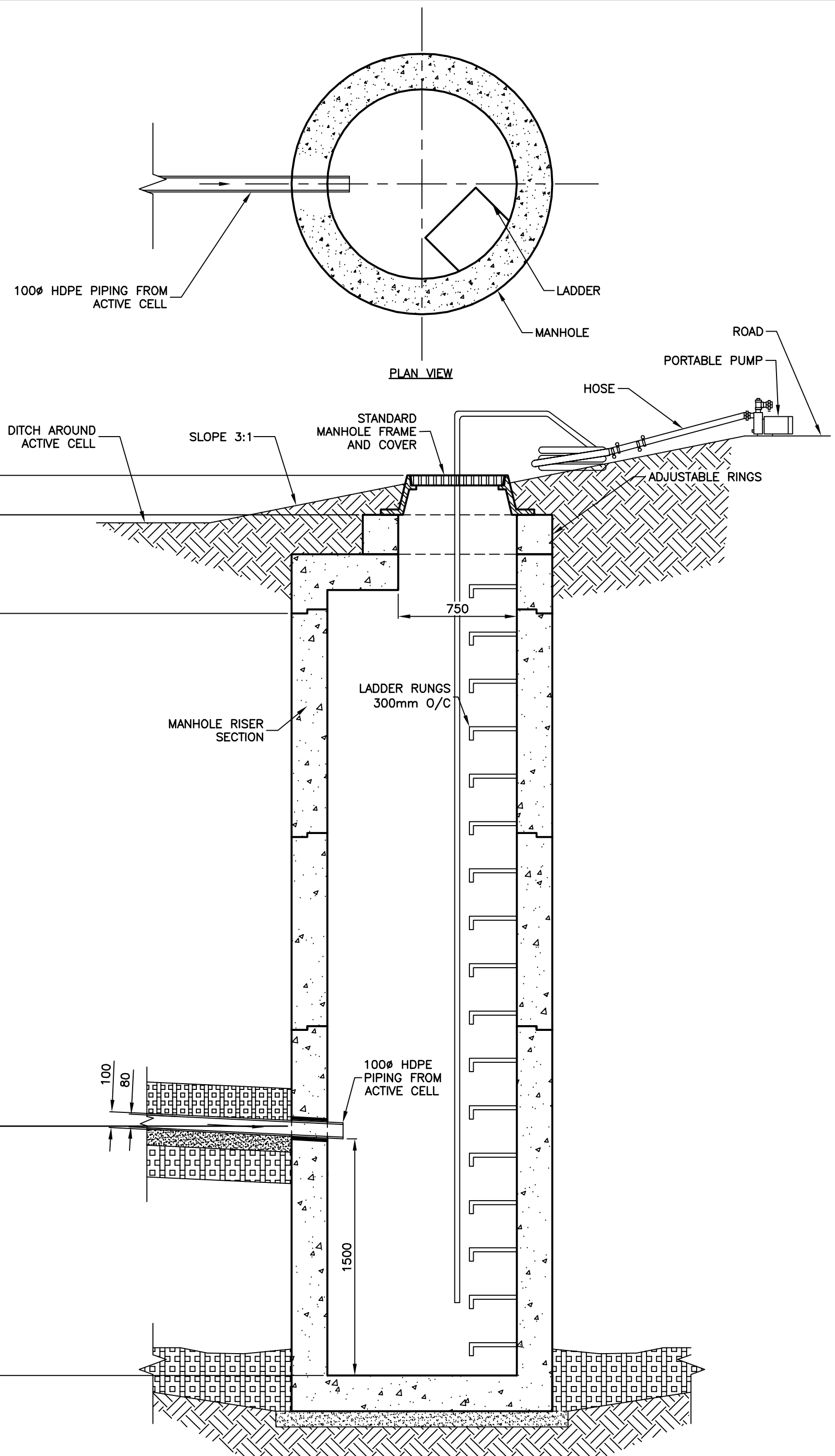

1 ACTIVE CELL MANHOLE DETAIL
SCALE = 1:25

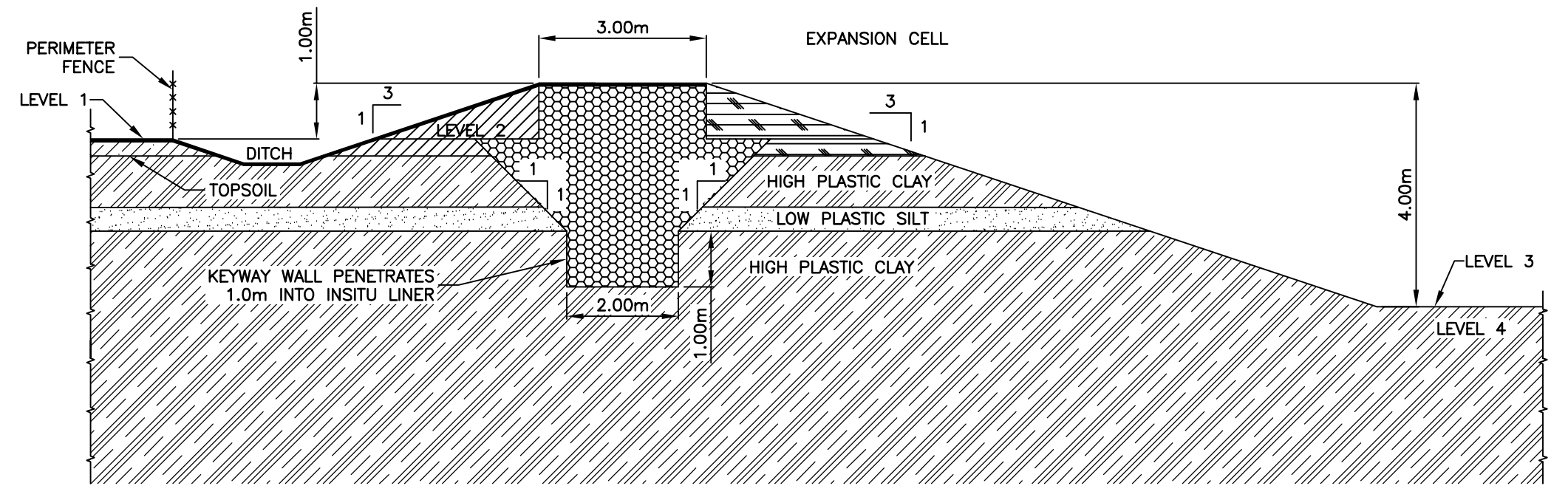

2 EXPANSION CELL PERIMETER DIKE
SCALE = 1:100

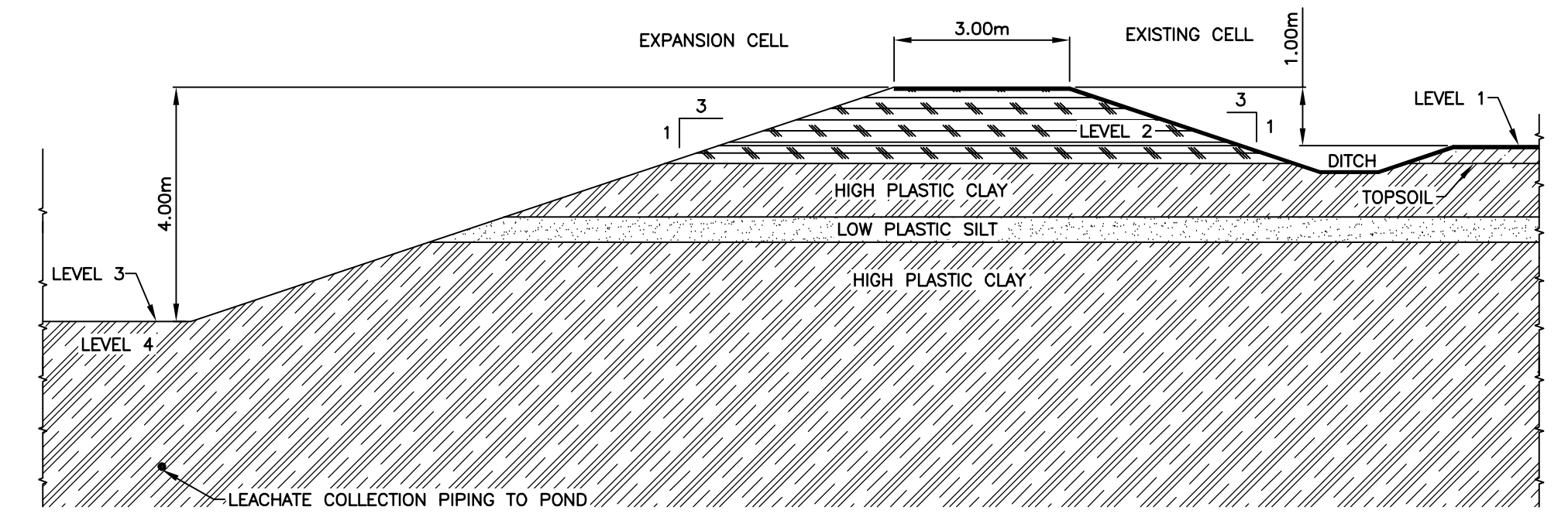

3 EXPANSION CELL PERIMETER DIKE
SCALE = 1:100

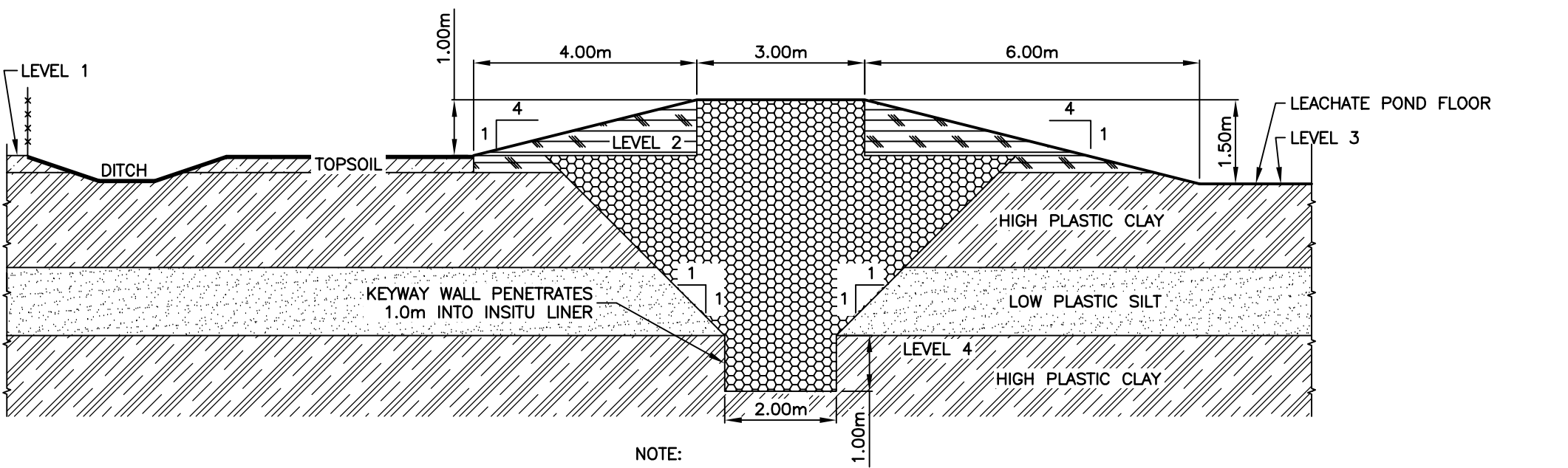

4 LEACHATE POND PERIMETER DIKE
SCALE = 1:100

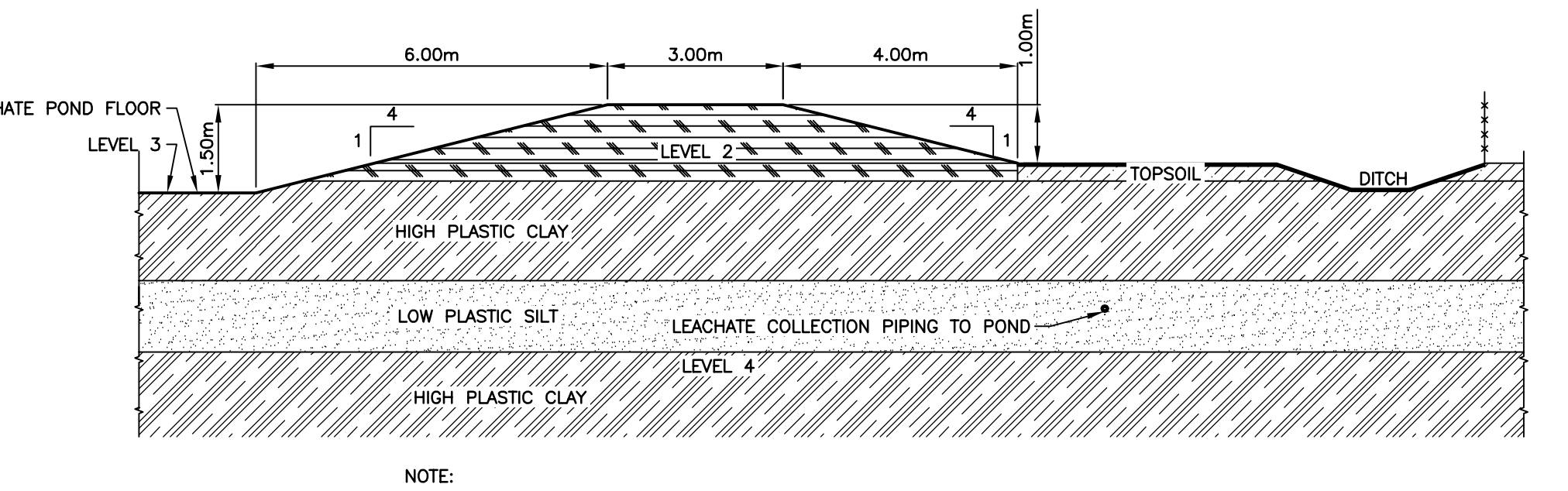

5 LEACHATE POND PERIMETER DIKE
SCALE = 1:100

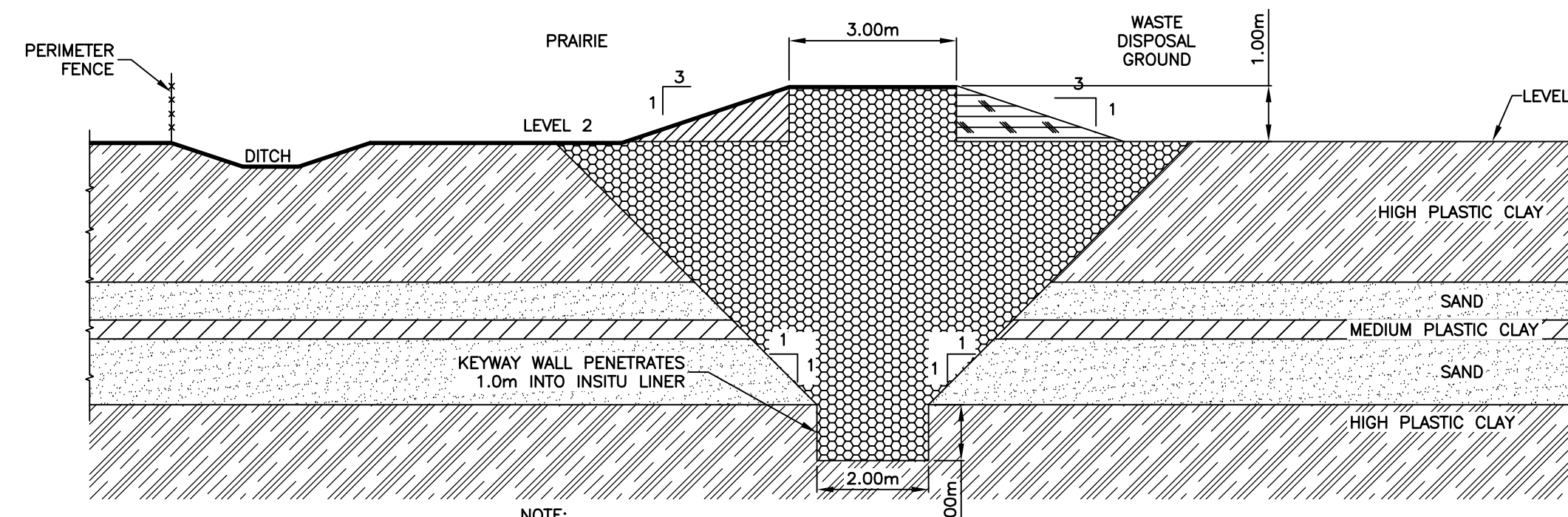

6 EXPANSION CELL PERIMETER DIKE
SCALE = 1:100

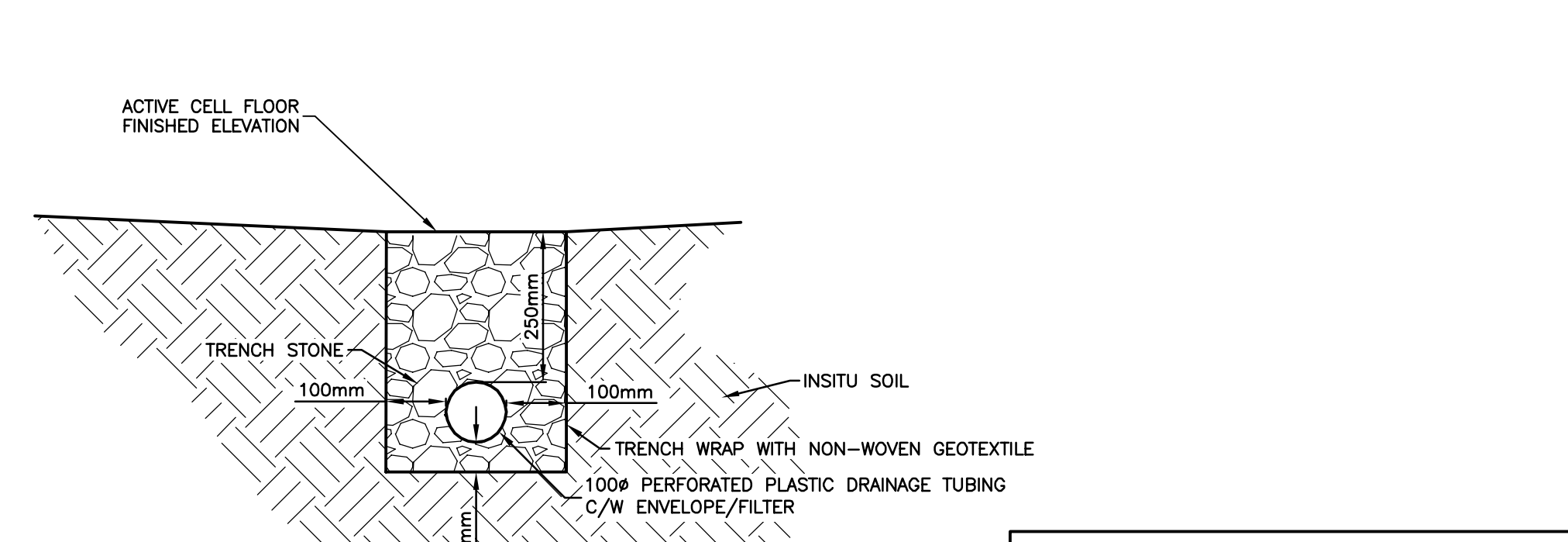

7 LEACHATE COLLECTION PIPING DETAIL
SCALE: 1:10

PRELIMINARY
NOT FOR CONSTRUCTION

No.	REVISIONS	DATE	INITIALS

B.M. EL.
LOCATIONS OF UNDERGROUND STRUCTURES/UTILITIES AS SHOWN ARE BASED ON AVAILABLE INFORMATION BUT NO GUARANTEE IS GIVEN OR IMPLIED THAT ALL EXISTING UNDERGROUND STRUCTURES/UTILITIES ARE SHOWN OR THAT THE GIVEN LOCATIONS ARE EXACT. CONFIRMATION OF EXISTENCE AND EXACT LOCATION OF ALL UNDERGROUND STRUCTURES/UTILITIES MUST BE OBTAINED FROM THE APPROPRIATE AUTHORITY/OWNER, BY THE CONTRACTOR, BEFORE PROCEEDING WITH CONSTRUCTION.

APECM
Certificate of Authorization
J.R. Cousin Consultants Ltd.
No. 234 Date: 16/04/06

JR ENGINEERING CONSULTANTS
ENGINEERING EXCELLENCE SINCE 1981
JR Cousin Consultants Ltd.
91A Scurfield Blvd. Winnipeg MB R3Y 1G4
p. (204) 489-0474
f. (204) 489-0487
www.jrcc.ca

CODE: A-677.05	PROJECT: TOWN OF ALTONA WASTE DISPOSAL GROUND EXPANSION EAP
DESIGNED BY: OW	TITLE: DIKE LINER, LEACHATE PIPE AND LIFT STATION DETAILS
DRAWN BY: RH	SCALE: AS NOTED
REVIEWED BY: JRC	DATE: 15/12/17
	PLAN: 4
	SHEET: 4 of 6

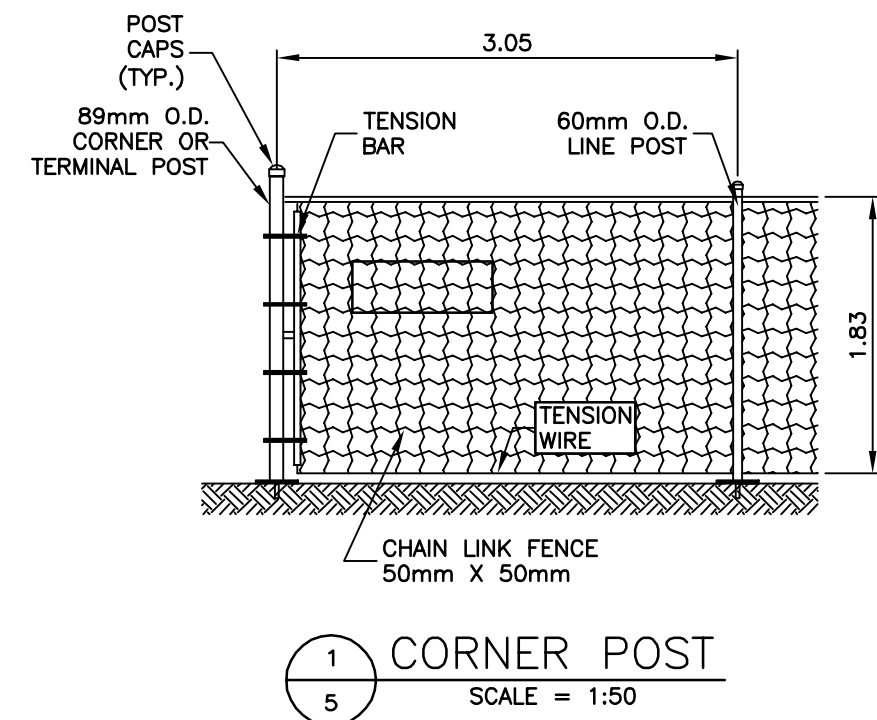

1 CORNER POST
SCALE = 1:50

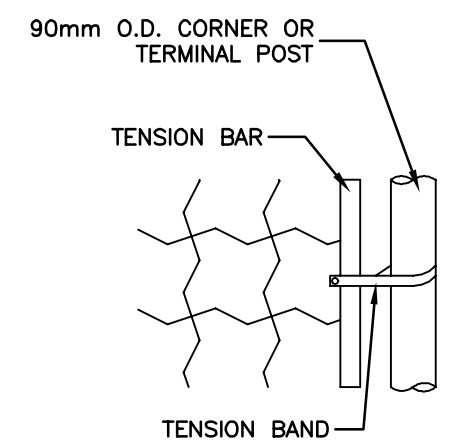

2 TENSION BAR
SCALE = 1:15

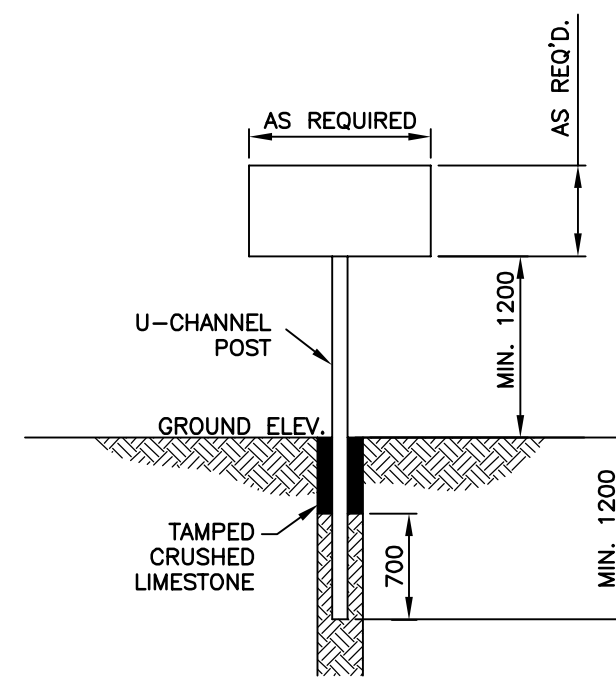

3 SIGN DETAIL
SCALE = 1:50

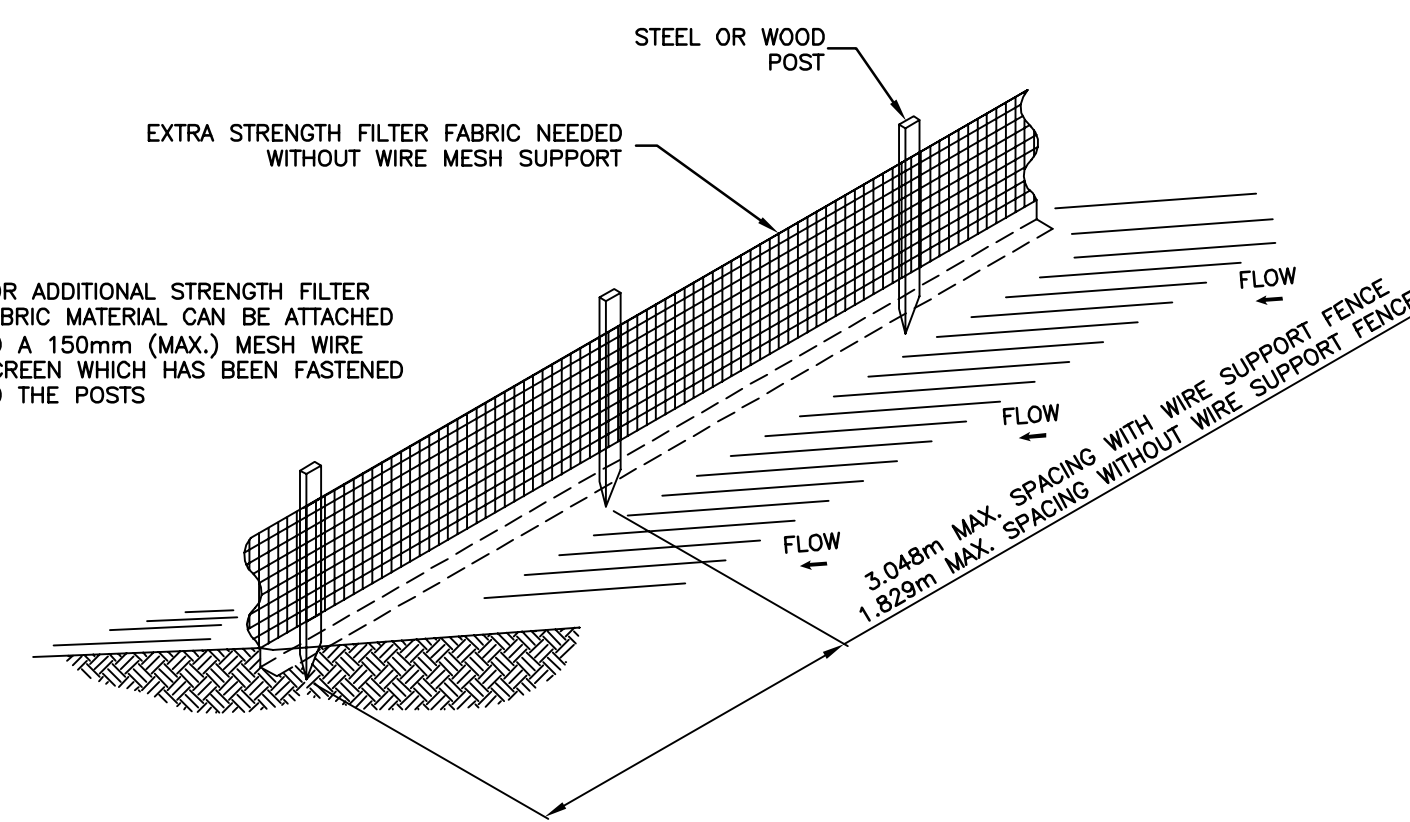

NOTES:

1. THE HEIGHT OF A SILT FENCE SHALL NOT EXCEED 914mm.
2. THE FILTER FABRIC SHALL BE PURCHASED IN A CONTINUOUS ROLL CUT TO THE LENGTH OF THE BARRIER TO AVOID THE USE OF JOINTS.
3. POSTS SHALL BE SPACED A MAXIMUM OF 3.048m APART AT THE BARRIER LOCATION AND DRIVEN SECURELY INTO THE GROUND A MINIMUM OF 300mm. WHEN EXTRA STRENGTH FABRIC IS USED WITHOUT THE WIRE SUPPORT FENCE, POST SPACING SHALL NOT EXCEED 1.829m.
4. A TRENCH SHALL BE EXCAVATED APPROXIMATELY 100mm WIDE AND 100mm DEEP ALONG THE LINE OF POSTS AND UPSLOPE FROM THE BARRIER.
5. WHEN STANDARD STRENGTH FILTER FABRIC IS USED, A WIRE MESH SUPPORT FENCE SHALL BE FASTENED SECURELY TO THE UPSLOPE SIDE OF THE POSTS USING HEAVY DUTY WIRE STAPLES AT LEAST 25mm LONG, THE WIRES, OR HOG RINGS. THE WIRE SHALL EXTEND INTO THE TRENCH A MINIMUM OF 50mm AND SHALL NOT EXTEND MORE THAN 914mm ABOVE THE ORIGINAL GROUND SURFACE.
6. THE STANDARD STRENGTH FILTER FABRIC SHALL BE STAPLED OR WIRED TO THE FENCE, AND 200mm OF THE FABRIC SHALL BE EXTENDED INTO THE TRENCH. THE FABRIC SHALL NOT EXTEND MORE THAN 914mm ABOVE THE ORIGINAL GROUND SURFACE.
7. THE TRENCH SHALL BE BACKFILLED AND THE SOIL COMPACTED OVER THE FILTER FABRIC.
8. SILT FENCING TO BE POLYPROPYLENE SYNTHETIC FIBRE WITH ULTRAVIOLET STABILIZERS. AMOCO 1198 OR APPROVED EQUAL.
9. WOOD POSTS TO BE 38mm X 89mm (2" X 4"), POINTED AT ONE END AND FABRICATED.
10. INSTALL ALL SUPPORTING POSTS ON THE DOWN SLOPE SIDE OF THE FENCING
11. MAINTAIN SILT FENCE THROUGHOUT CONSTRUCTION AND UNTIL REVEGETATION OCCURS.

4 SILT FENCE DETAIL
SCALE = 1:40

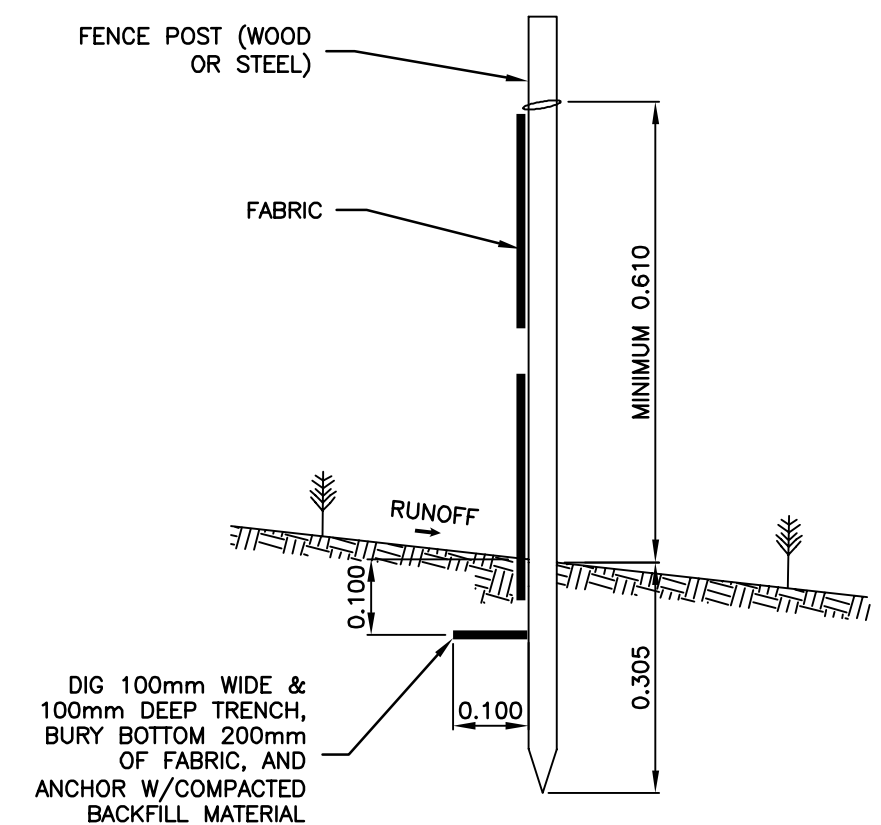

5 SILT FENCE SECTION
SCALE = 1:10

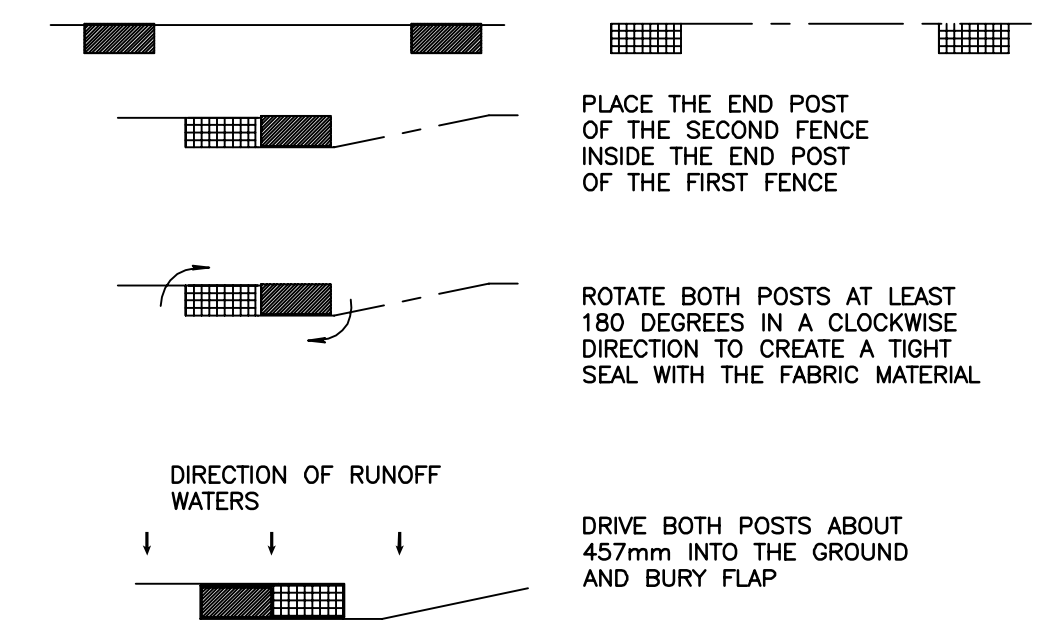

6 ATTACHING TWO SILT FENCES
SCALE = 1:10

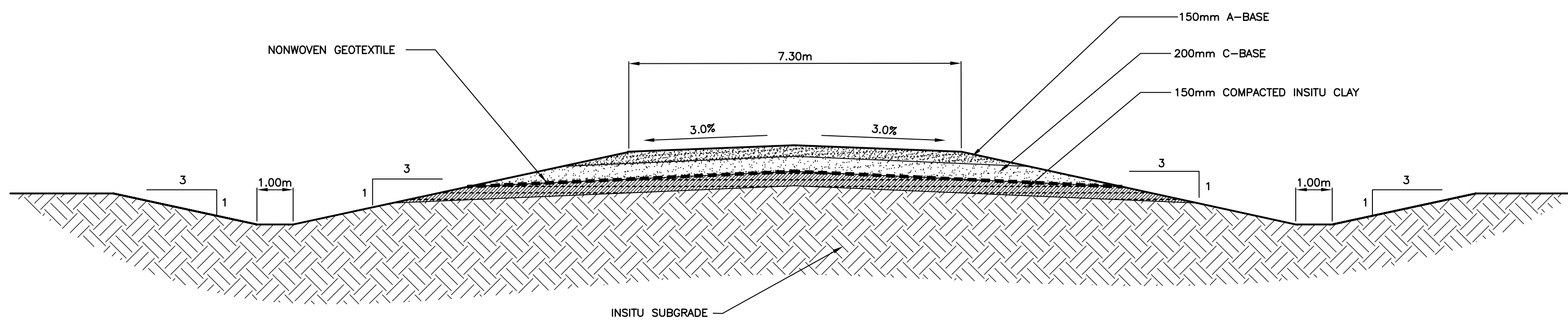

7 ACCESS ROAD CROSS-SECTION
SCALE = NTS

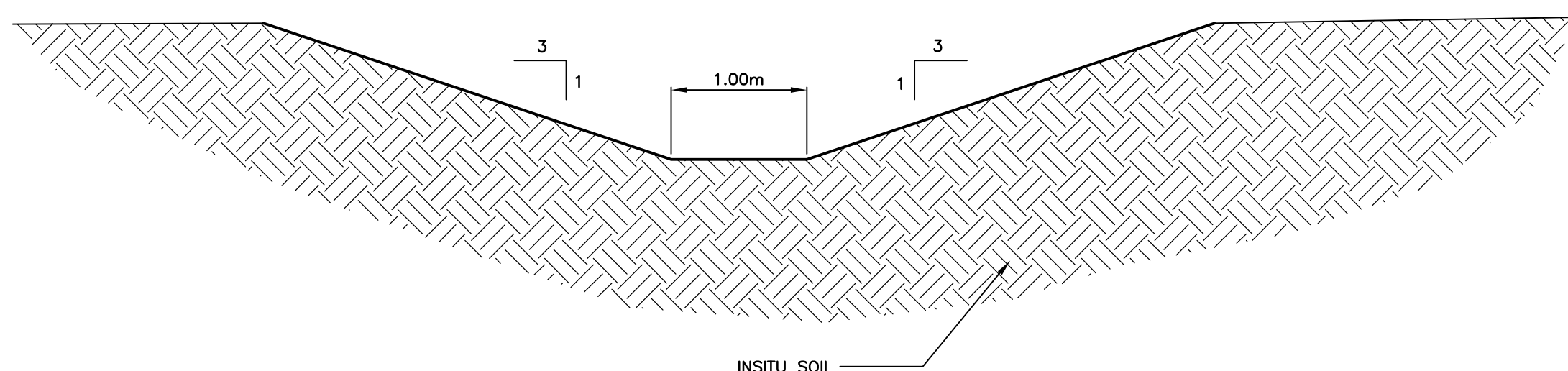

8 TYPICAL DITCH CROSS-SECTION
SCALE = NTS

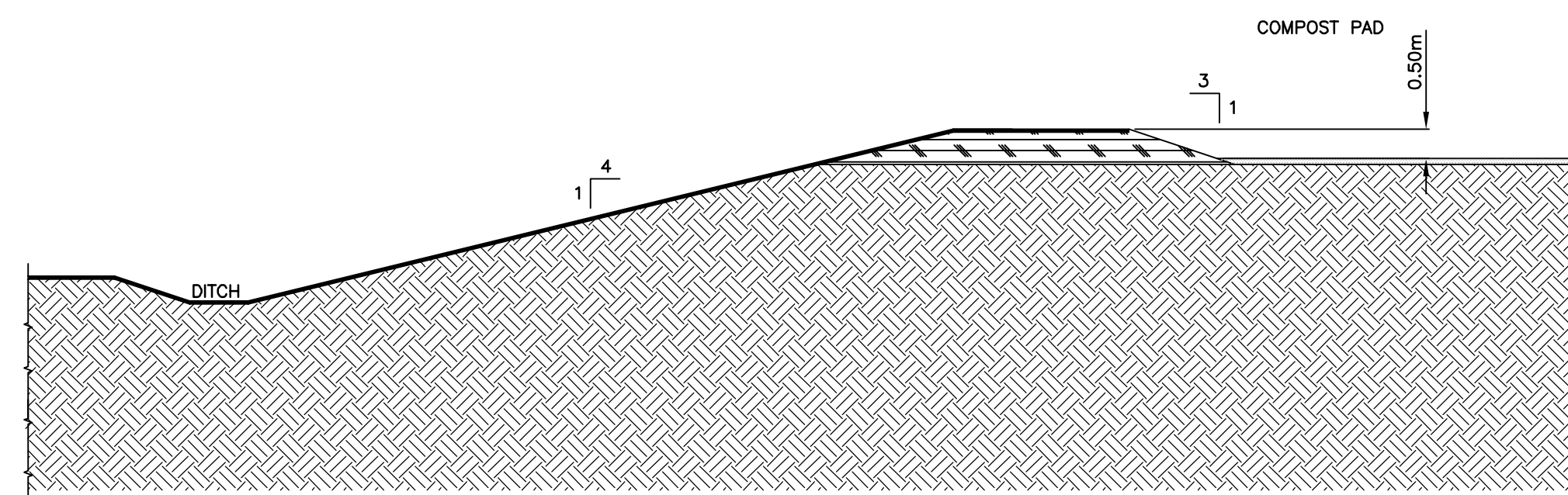

9 COMPOST PAD DETAIL
SCALE = 1:100

LEGEND:

- EXCAVATED AND COMPACTED MIXTURE OF ORGANIC AND INORGANIC SOILS
- TOPSOIL
- INSITU
- ASPHALT MILLINGS

PRELIMINARY
NOT FOR CONSTRUCTION

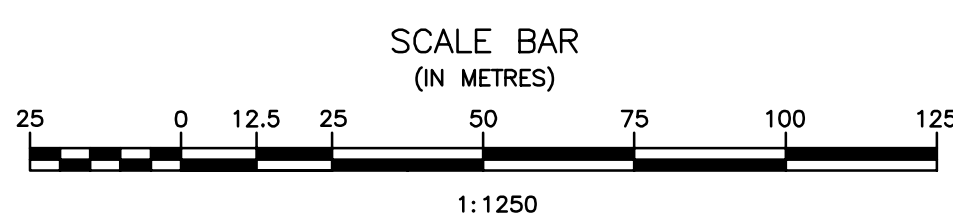

No.	REVISIONS	DATE	INITIALS	B.M. EL.

LOCATIONS OF UNDERGROUND STRUCTURES/UTILITIES AS SHOWN ARE BASED ON AVAILABLE INFORMATION BUT NO GUARANTEE IS GIVEN OR IMPLIED THAT ALL EXISTING UNDERGROUND STRUCTURES/UTILITIES ARE SHOWN OR THAT THE GIVEN LOCATIONS ARE EXACT. CONFIRMATION OF EXISTENCE AND EXACT LOCATION OF ALL UNDERGROUND STRUCTURES/UTILITIES MUST BE OBTAINED FROM THE APPROPRIATE AUTHORITY/OWNER, BY THE CONTRACTOR, BEFORE PROCEEDING WITH CONSTRUCTION.

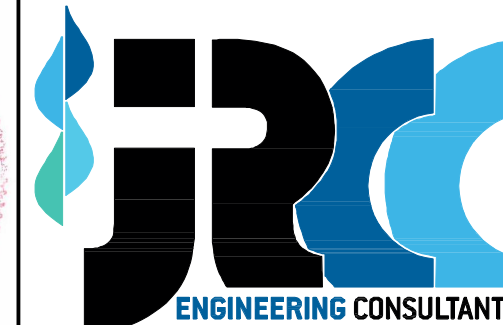
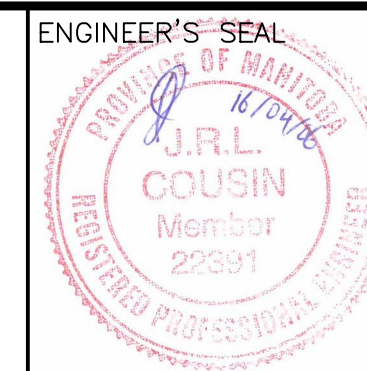
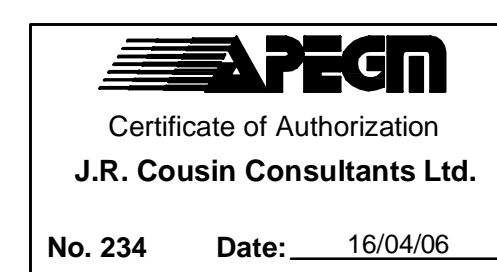

JR Cousin Consultants Ltd.
91A Scurfield Blvd. Winnipeg MB R3Y 1G4
p. (204) 489-0474
f. (204) 489-0487
www.jrcc.ca

ENGINEERING EXCELLENCE SINCE 1981

CODE: A-677.05	PROJECT: TOWN OF ALTONA WASTE DISPOSAL GROUND EXPANSION EAP
DESIGNED BY: OW	TITLE: ROAD, DITCH, FENCE, SILT FENCE, COMPOST PAD AND SIGN DETAILS
DRAWN BY: RH	SCALE: AS NOTED
REVIEWED BY: JRC	DATE: 15/12/17
	PLAN: 5
	SHEET: 5 of 6

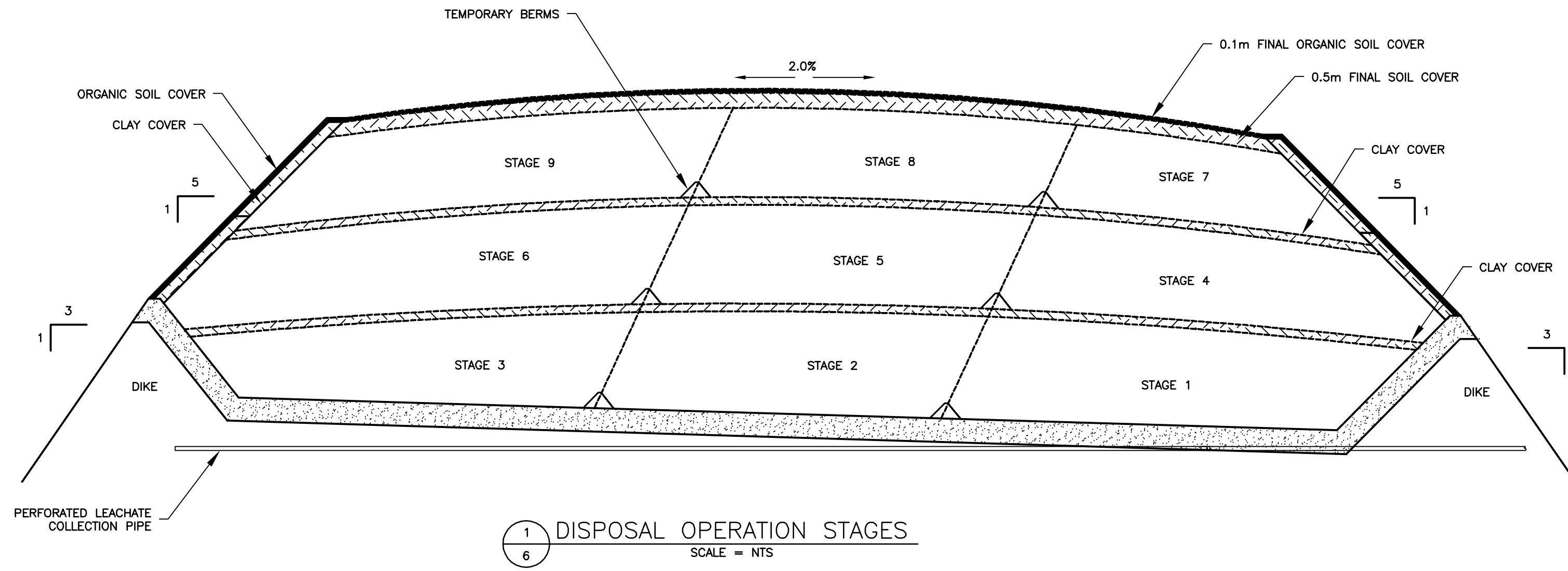

1 DISPOSAL OPERATION STAGES
SCALE = NTS

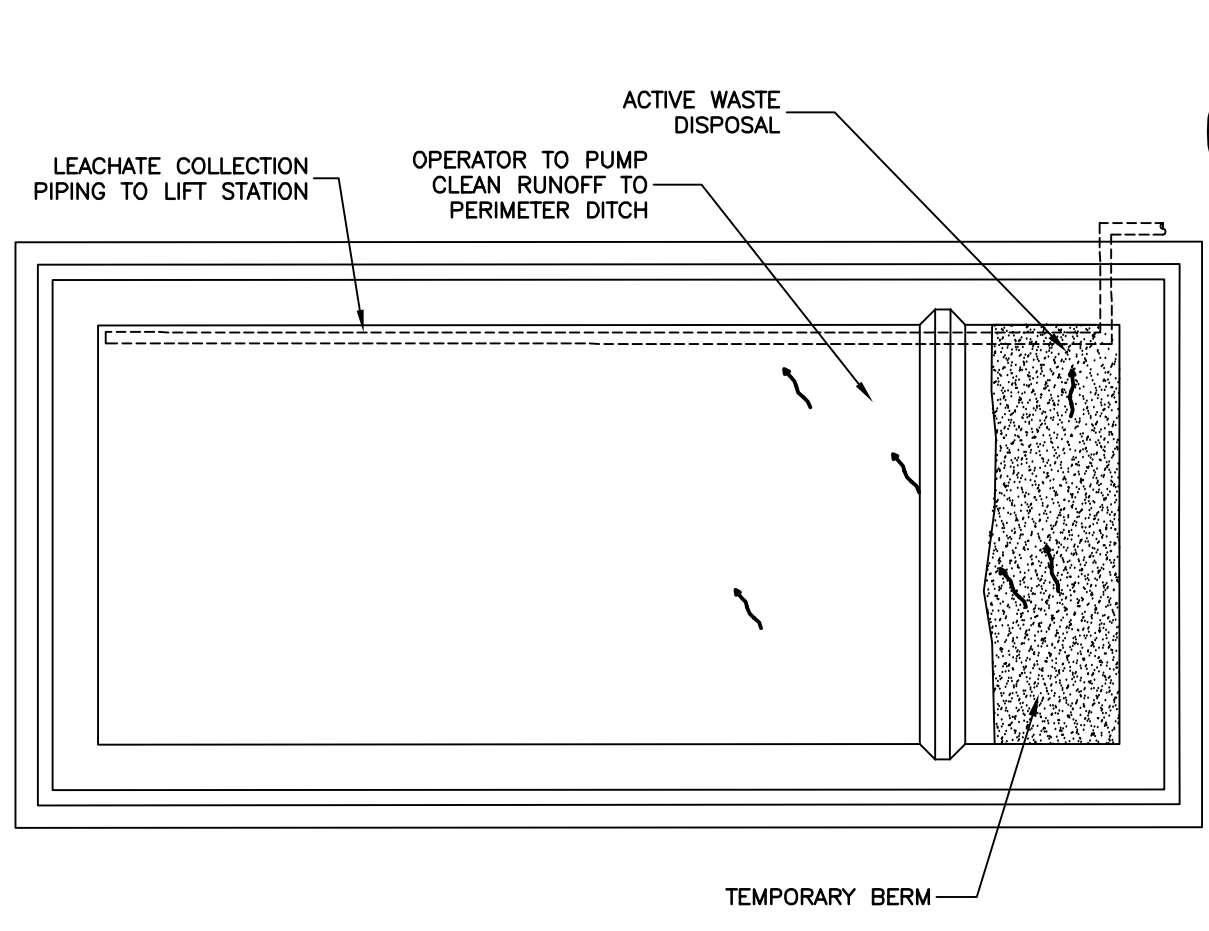

2 STAGE 1
SCALE = NTS

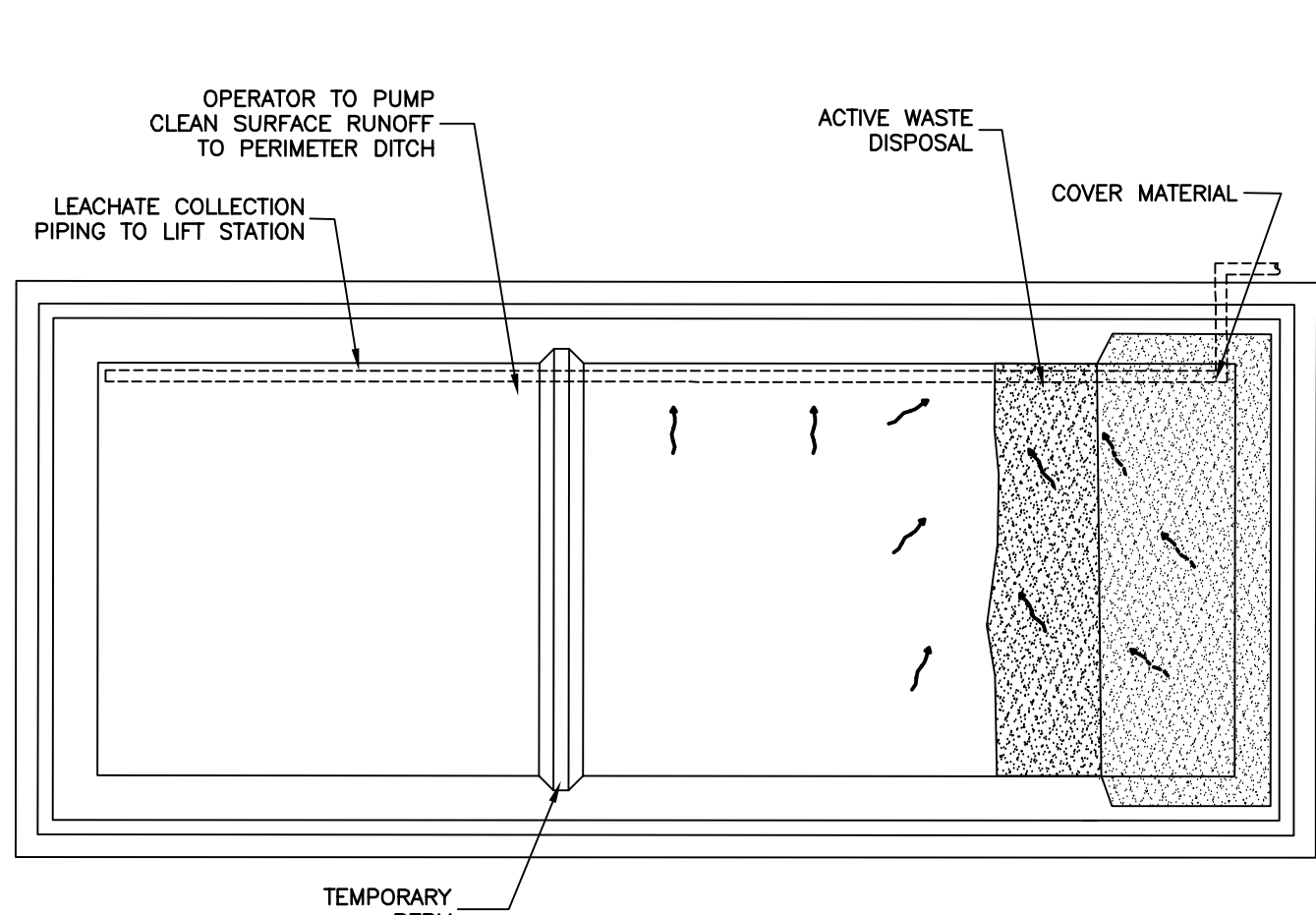

4 STAGE 2
SCALE = NTS

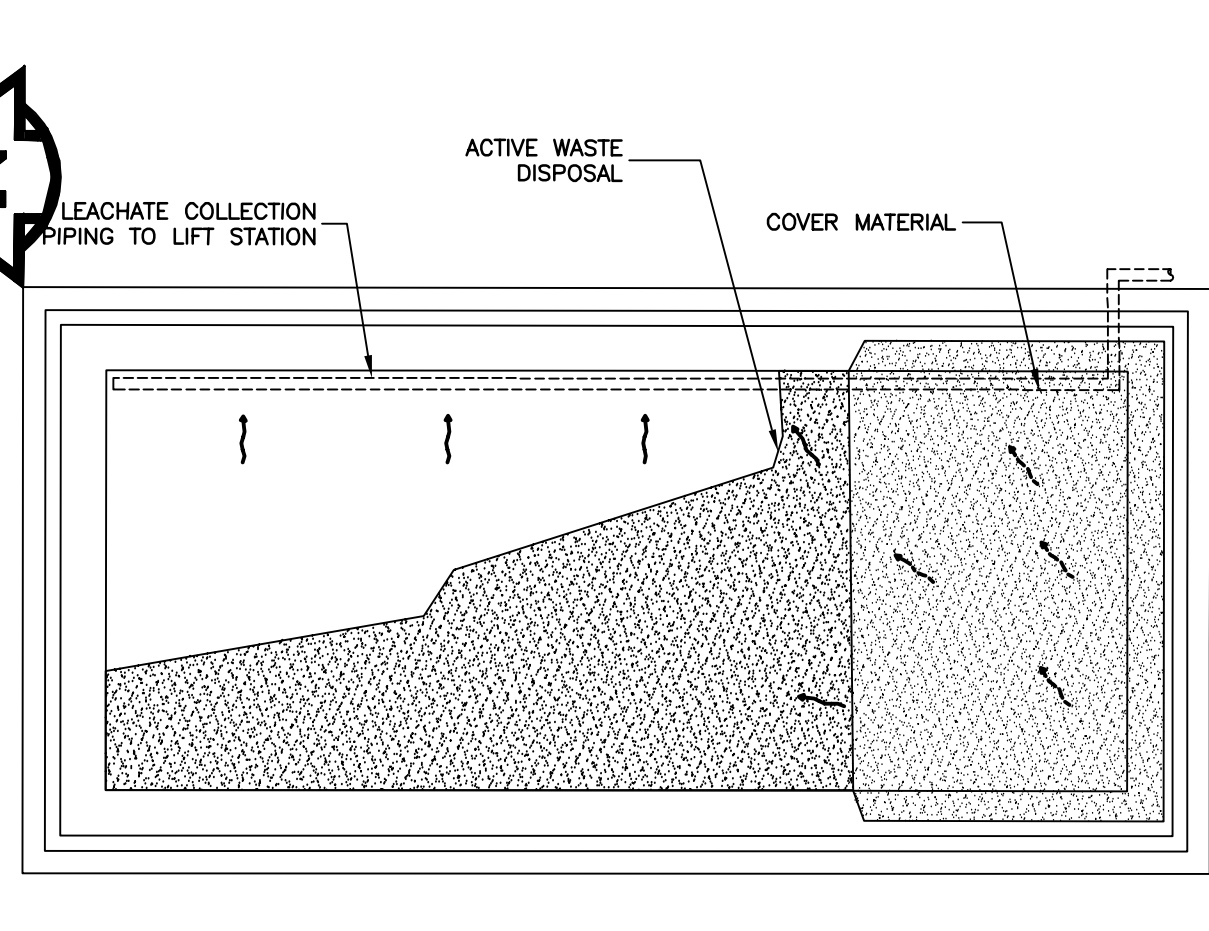

6 STAGE 3
SCALE = NTS

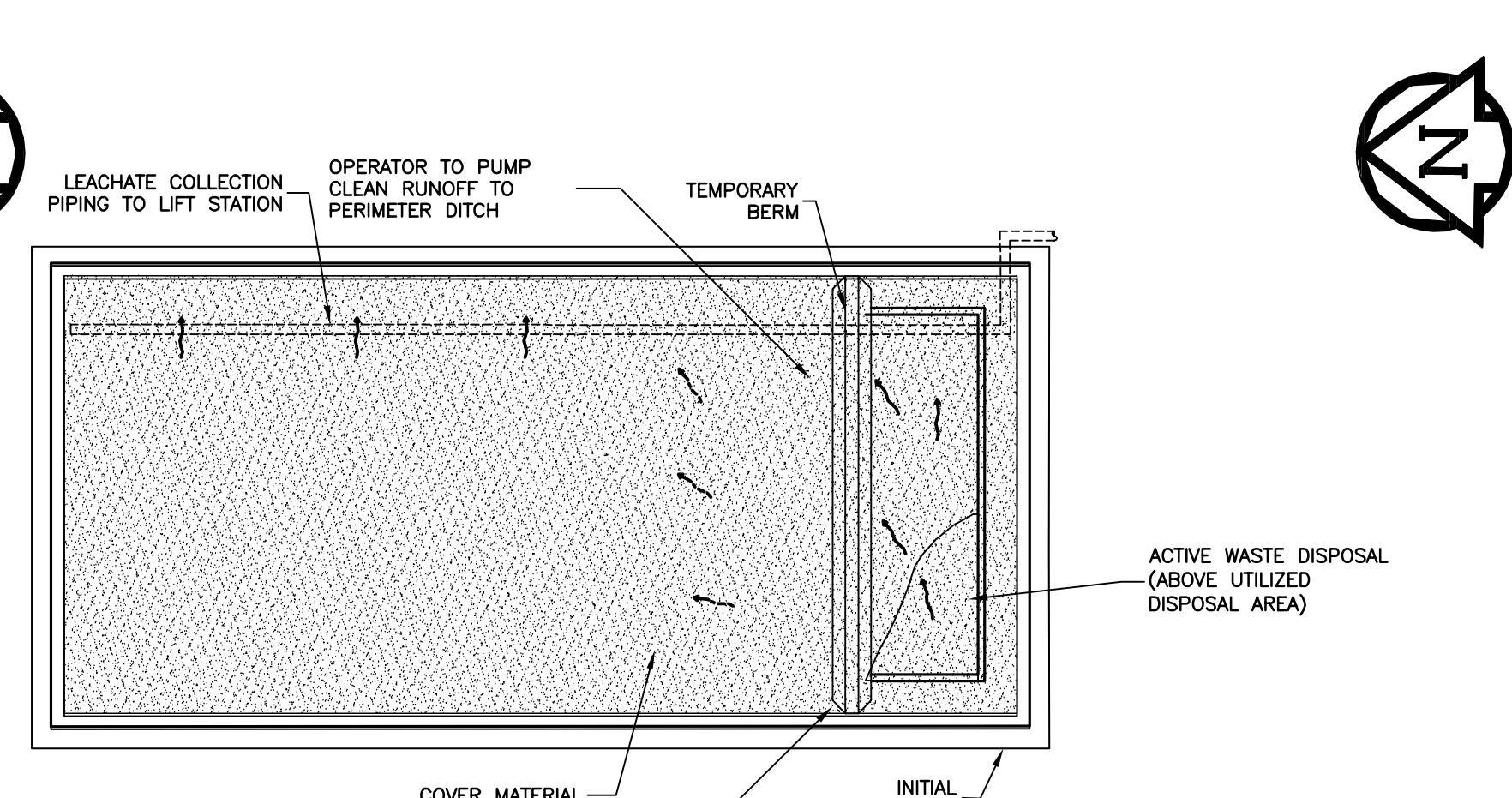

8 STAGE 4
SCALE = NTS

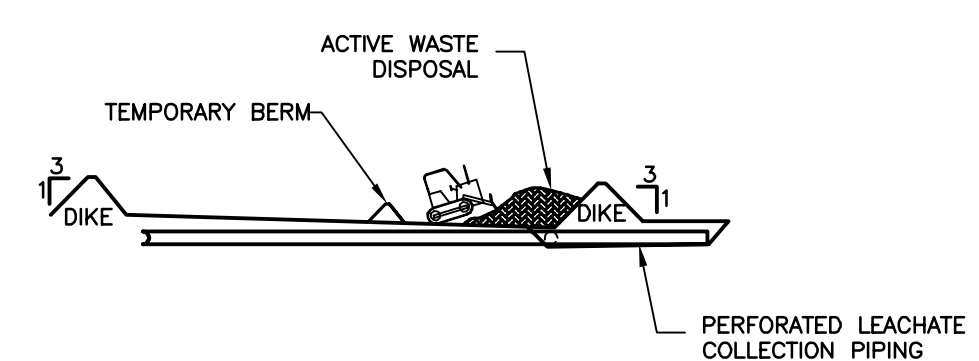

3 STAGE 1 - CROSS SECTION
SCALE = NTS

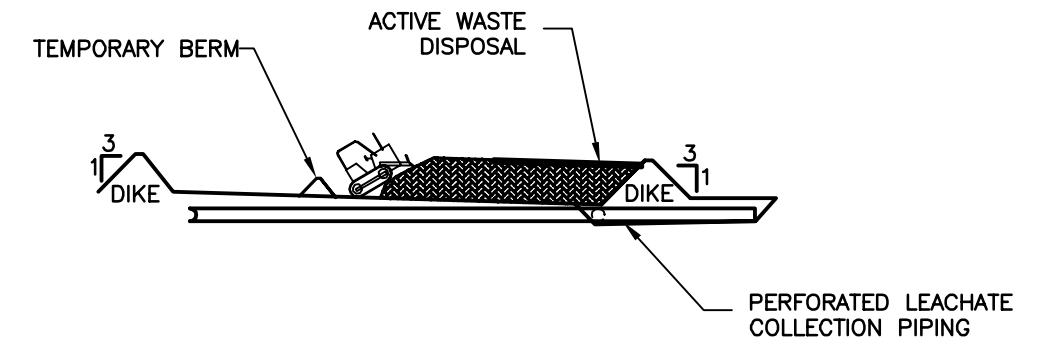

5 STAGE 2 - CROSS SECTION
SCALE = NTS

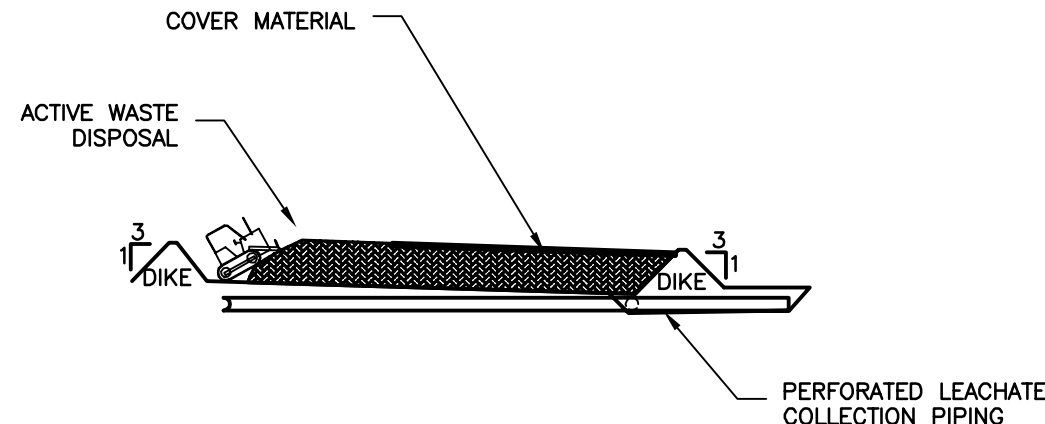

7 STAGE 3 - CROSS SECTION
SCALE = NTS

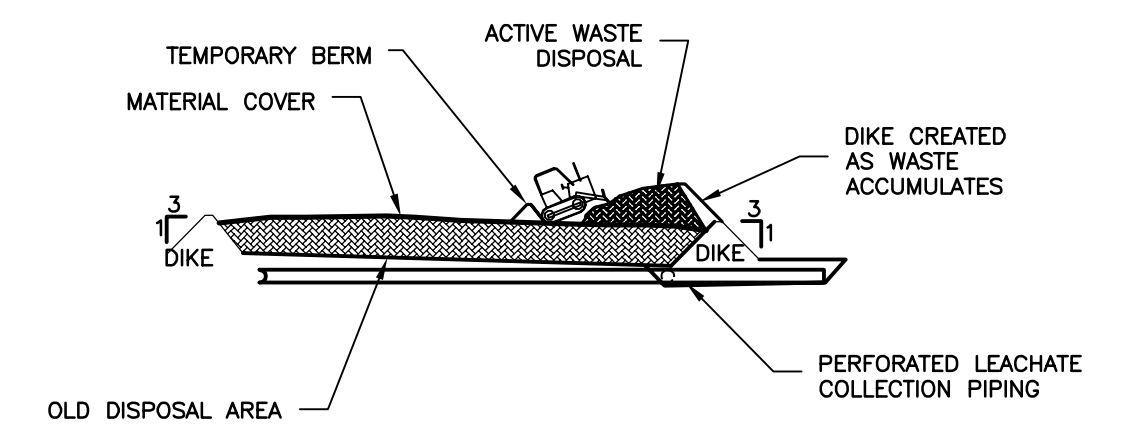

9 STAGE 4 - CROSS SECTION
SCALE = NTS

PRELIMINARY
NOT FOR CONSTRUCTION

No.	REVISIONS	DATE	INITIALS

B.M. EL.
LOCATIONS OF UNDERGROUND STRUCTURES/UTILITIES AS SHOWN ARE BASED ON AVAILABLE INFORMATION BUT NO GUARANTEE IS GIVEN OR IMPLIED THAT ALL EXISTING UNDERGROUND STRUCTURES/UTILITIES ARE SHOWN OR THAT THE GIVEN LOCATIONS ARE EXACT. CONFIRMATION OF EXISTENCE AND EXACT LOCATION OF ALL UNDERGROUND STRUCTURES/UTILITIES MUST BE OBTAINED FROM THE APPROPRIATE AUTHORITY/OWNER, BY THE CONTRACTOR, BEFORE PROCEEDING WITH CONSTRUCTION.

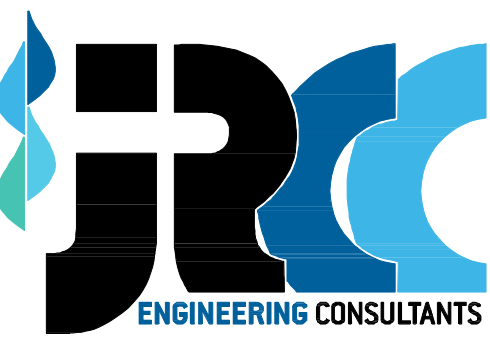
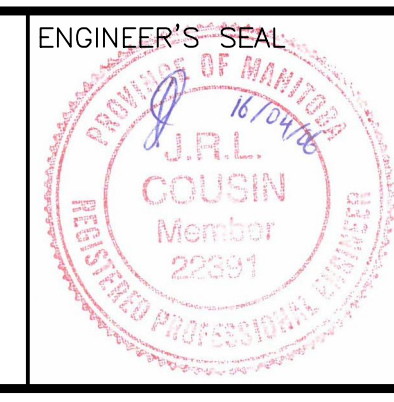
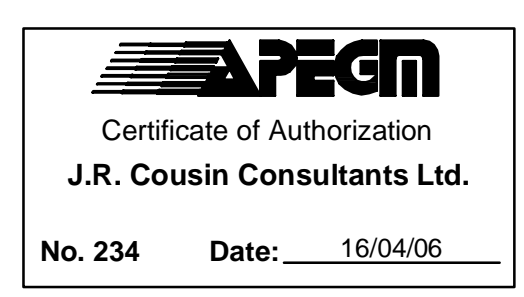

JR Cousin Consultants Ltd.
91A Scurfield Blvd. Winnipeg MB R3Y 1G4
p. (204) 489-0474
f. (204) 489-0487
www.jrcc.ca

CODE: A-677.05	PROJECT: TOWN OF ALTONA WASTE DISPOSAL GROUND EXPANSION EAP
DESIGNED BY: OW	TITLE: SITE OPERATIONS PLAN
DRAWN BY: RH	SCALE: AS NOTED
REVIEWED BY: JRC	DATE: 15/12/17
	PLAN: 6
	SHEET: 6 of 6

Apr 06, 2016 - 9:50am P:\000077 Altona - Town\07720 Waste Disposal Ground Expansion EAP\04 Site Operations\04\01\01.dwg