

March 18, 2014

Director, Environmental Approvals Branch  
Manitoba Conservation and Water Stewardship  
Suite 160, 123 Main Street  
Winnipeg, MB R3C 1A5

**Reference: Environmental Act Proposal  
Domestic Wastewater Lagoon  
RM of Oakland, MB**

Dear Director,

Burns Maendel Consulting Engineers Ltd. is pleased to submit an Environment Act Proposal for the proposed Domestic Wastewater Lagoon in the RM of Oakland on behalf of Oakland Colony. This Domestic Wastewater Lagoon will be sized to treat wastewater from the entire colony as it expands to a design population of 150 people.

All of the information relating to the Environmental Act Proposal has been compiled in the attached document. Four (4) hard copies of our proposal have been included, as well as one (1) electronic copy. If you have any questions or comments, please don't hesitate to contact the undersigned.

Regards,



Daniel Burns, P. Eng.

Cc: Jonathan Waldner  
Gerald Waldner



/enclosed

Director, Environmental Approvals Branch  
Manitoba Conservation and Water Stewardship  
Suite 160, 123 Main Street  
Winnipeg, MB R3C 1A5

**Environmental Act Proposal**  
Domestic Wastewater Lagoon  
RM of Oakland, MB

Submitted by:

Burns Maendel Consulting Engineers Ltd.  
1331 Princess Ave.  
Brandon, MB R7A 0R4  
Tel: 204.728.7364  
Fax: 204.728.4418

On behalf of:

Jonathan Waldner  
Oakland Colony  
RM of Oakland  
Box 18  
Carroll, MB R0K 0K0  
Tel: 204.483.2641  
Fax: 204.570.3302

March 18, 2014

## **Executive Summary**

Oakland Colony is a newly established colony made up of 16 people with another 6 arriving shortly, situated approximately 20 km south of Brandon. They originated as a daughter colony of Marble Ridge Colony. To establish their colony they purchased an old farm site and moved into temporary housing. Other on-site buildings include a church, several shops and various machine and farm sheds. They have begun planning for expansion, and have retained Burns Maendel Consulting Engineers Ltd (BMCE) for engineering support.

As part of the expansion, Oakland Colony requires a new wastewater treatment facility to manage their wastewater effluent. Due to the site conditions as well as the isolation of the site, BMCE is proposing a domestic wastewater lagoon be built. BMCE is responsible for the design of the wastewater treatment lagoon, as well as the generation of this corresponding EAP. BMCE is proposing a new two-cell geomembrane-lined lagoon be constructed. The primary cell will have a volume of 3,094 m<sup>3</sup> and the secondary cell will have a volume of 6,394 m<sup>3</sup> for a combined total of 9,488 m<sup>3</sup>. The proposed lagoon will be complete with a gas venting and groundwater mitigation system.

The proposed discharge location for the lagoon is into a local drain. From there, the drain connects to the Little Souris River approximately 10 km downstream. The Little Souris then terminates at the Assiniboine River approximately 40 km downstream from the lagoon. No significant adverse impact on human health or the environment is anticipated to result from the proposed construction and operation of the lagoon, as will be elaborated on within the Environment Act Proposal.

Once approval for the lagoon has been received from Manitoba Conservation, construction is planned to begin in early summer.



## **Standard Limitations**

This report was prepared by Burns Maendel Consulting Engineers Ltd. (BMCE) for the account of Oakland Colony (the Client). The disclosure of any information contained in this report is the sole responsibility of the Client. The material in this report reflects BMCE's best judgment in light of the information available to it at the time of preparation. Should this report be used by a third party, any reliance or decisions made based on this report are the responsibility of such third party. BMCE accepts no responsibility for damages, if any, suffered by a third party as a result of decisions made or actions based on this report. BMCE makes no representation concerning the legal significance of the findings or the information contained within this report.

## Table of Contents

1. Introduction and Background.....	1
2. Description of Proposed Development.....	1
2.1. Certificate of Title.....	1
2.2. Legal Land Description, Map of Proposed Development .....	2
2.3. Water Source .....	2
2.4. Sealed Engineering Drawings .....	2
2.5. Sizing Parameters and Calculations.....	2
2.5.1. Summary Table .....	2
2.5.2. Hydraulic Loading .....	3
2.5.3. Organic Loading.....	3
2.5.4. Lagoon Design.....	3
2.6. Synthetic Geomembrane Liner Details .....	4
2.7. Discharge Route .....	4
2.8. Facility Operation.....	5
2.9. Seasonal Maintenance .....	6
3. Description of Pre-Development Environment .....	7
3.1. Land Use .....	7
3.2. Topography .....	7
3.3. Soil Conditions .....	7
3.4. Groundwater .....	7
3.5. Protected or Endangered Species .....	7
3.6. Socioeconomic Environment .....	7
4. Description of Environmental and Human Health Effects of the Proposed Development. 8	
4.1. Impact on Biophysical Environment .....	8
4.1.1. Construction.....	8
4.1.2. Operation .....	8
4.2. Type, Quantity and Concentration of Pollutants .....	8
4.2.1. General .....	8
4.2.2. Phosphorus.....	9
4.2.3. Other Nutrients.....	9
4.3. Fish Habitat .....	9

4.4.	Socio-Economic, Climate Change Implications .....	10
4.5.	Potential Impact on Human Health and Safety .....	10
5.	Mitigation Measures and Residual Environmental Effects .....	10
5.1.	Protection.....	10
5.2.	Monitoring .....	11

## **List of Appendices**

Appendix A – Certificate of Title .....	i
Appendix B – Manitoba Conservation Data Centre Correspondence .....	ii
Appendix C – Office of Drinking Water Correspondence .....	iii
Appendix D – Fish Habitat Map .....	iv
Appendix E – Drawing Package .....	v
Appendix F – Geotechnical Report.....	vi

## **1. Introduction and Background**

Oakland Colony is a recently established colony based in the RM of Oakland, originating as a daughter colony of Marble Ridge Colony. They have bought an old farm site directly beside PR 112, where they have moved into temporary housing. The colony is comprised of housing units, several shops, a church, and various machine and farm sheds. The colony's industry revolves around farming several acres of the surrounding area. The current population of Oakland Colony is 16 members, soon to be 22, although the colony is planning for future expansion. To aid in the development process, the colony has retained Burns Maendel Consulting Engineers Ltd. (BMCE) to develop a site concept and layout plan, as well as water and wastewater treatment design.

As Oakland is a new colony, they will require a means of managing their wastewater effluent. Their current onsite wastewater management system is an infiltration field. As the current wastewater loading is under 10,000 L per day, the infiltration field is being operated under Regulation 83/2003 Onsite Wastewater Management Systems. However, this system does not have sufficient capacity to accommodate the anticipated colony growth. BMCE is therefore proposing construction of a domestic wastewater stabilization pond, or 'lagoon', for storage and treatment of wastewater prior to discharge into a local drain. This drain will be identified on a map of the proposed development later in the report.

Sewage infrastructure for the proposed development will consist of a gravity flow sewer network which would service each of the different housing units in the future colony site, as well as the shops. It should be noted that no industrial waste will be generated at the colony site. The gravity flow sewer will be directed to a lift station, which will pump wastewater to the wastewater lagoon. The wastewater lagoon itself will be designed for a future population of 150 people.

The domestic wastewater lagoon was chosen for wastewater treatment due to several factors. One consideration is that the colony itself is reasonably isolated, as it is nearly 5 kilometers away from the nearest community (the town of Carroll). Another consideration is the ease of use and lack of maintenance required compared to an alternative wastewater treatment system. Finally, there is a convenient discharge location nearby. These combined factors make a lagoon treatment system the most logical method for treating wastewater.

## **2. Description of Proposed Development**

### **2.1. Certificate of Title**

Refer to Appendix A. The legal landowner is Carroll Holding Co. Ltd., which is one of the registered business names Oakland Colony operates under.

## 2.2. Legal Land Description, Map of Proposed Development

The legal land description where the domestic wastewater lagoon is situated is SW 9-8-19 WPM. For the map of the proposed development including the preliminary layout of the colony site, piping and lift station refer to the drawing package in Appendix E.

## 2.3. Water Source

Water for the colony will be drawn from a groundwater well and will be pumped to the different colony buildings. We are currently in the process of designing a water distribution system. We note that as the colony population is currently 16 and soon to be 22 the water usage is estimated at 6,050 L, based upon a 275 L/c/d rate. Therefore, a water rights license is not required at this time. A water rights license will be applied for at the appropriate time once the design has been finalized.

## 2.4. Sealed Engineering Drawings

Refer to Appendix E.

## 2.5. Sizing Parameters and Calculations

### 2.5.1. Summary Table

Parameter	Result
Detention Time (days)	230
Population	150
Hydraulic Loading Rate (L/c/d)	275
Primary Cell Storage Volume (m <sup>3</sup> )	3,094
Secondary Cell Storage Volume (m <sup>3</sup> )	6,394
<b>Total Storage Volume (m<sup>3</sup>)</b>	<b>9,488</b>
Organic Loading Rate (kg BOD <sub>5</sub> / c / d)	0.077
Organic Loading per Area (kg BOD <sub>5</sub> / ha·d)	56
Primary Cell Area (m <sup>2</sup> )	2062.5
Active Storage Depth (m)	1.50
Freeboard (m)	1.00
Dead Space (m)	0.15
Total Depth (m)	2.65
Cell Interior Side Slope	5:1
Primary Cell Outer Dimensions - L x W x H (m)	65.3 x 65.3 x 2.65
Primary Cell Floor Dimensions - L x W (m)	34.8 x 34.8
Secondary Cell Outer Dimensions - L x W x H (m)	113.8 x 65.3 x 2.65
Secondary Cell Floor Dimensions - L x W (m)	83.3 x 34.8



### 2.5.2. Hydraulic Loading

- The design population was set at **150 people**, the expected colony size before a daughter colony is formed.
- The hydraulic loading was estimated at a conservative value of **275 L/c/d**. This is based off of literature values as well as historical design wastewater loading rates from other colonies. This number will account for infiltration loading as well.
- The detention time was set at **230 days**. 227-230 days are commonly used detention times, based on the operational requirement that the wastewater effluent be discharged between June 15 and November 1.

230 days was also a convenient storage time, as it complements the discharge procedure. As the secondary cell wastewater is the only effluent that is allowed to discharge after testing, the wastewater in the primary cell remains. Iterative analysis showed that a 230 day storage volume would ensure that consecutive discharges are not necessary.

- Therefore, the required **Total Storage Volume** based upon the hydraulic loading parameters listed above is **9,488 m<sup>3</sup>**.

### 2.5.3. Organic Loading

- Again, the design population was set at **150 people**, as this slightly exceeds the maximum expected colony size before a daughter colony is formed.
- The design organic loading rate per person is set at **0.077 kg BOD/person/day**. This is a value used commonly in wastewater treatment design.
- The maximum organic loading is set at **56 kg BOD / (ha\*d)**. This value is commonly used in wastewater lagoon design across Manitoba.
- Therefore, on the basis of the above treatment parameters, the area needed in the primary cell is **2,062.5 m<sup>2</sup>**.

### 2.5.4. Lagoon Design

- Based upon the hydraulic and organic loading requirements, the **Primary Cell Storage Volume** will be equal to 3,094 m<sup>3</sup>. The **Secondary Cell Storage Volume** will be 6,394 m<sup>3</sup>.

- As per common practice and design standards for wastewater lagoon design, the available storage will be 1.5 m
- As per common practice in wastewater lagoon design, the available freeboard will be 1.0 m.
- The area below the secondary cell pipe invert is considered dead storage, and is not part of the design storage volume or freeboard. The dead storage height is 0.15 m, as per common design practice.
- The interior slope of the primary and secondary cell will be 5:1. The outside of the berm will also have a slope of 4:1.
- Erosion due to wave action is a concern, as the sand cover over the liner is more susceptible to this type of damage than a compacted clay liner. Therefore, a bench will be built approximately 600 mm below the height of the maximum design water level. Rip-rap consisting of cobbled stones will then be installed on the bench to a level of 600-mm above the maximum design water level. For more detailed information, refer to the drawing details in Appendix E.
- For all other lagoon design details, refer to the drawings in Appendix E.

## **2.6. Synthetic Geomembrane Liner Details**

A synthetic geomembrane liner will be used as the surrounding soil is sandy, prohibiting use of a compacted clay lined design, and there is no clay deposit readily available for a clay liner. Cover material will be placed over the lagoon sides and bottom for a depth of 300 mm. A gas ventilation system consisting of a wick vapor drain will be used to prevent gas build-up underneath the synthetic liner. The wick vapor drain will also function as a dewatering system. For drawing details, refer to Appendix E.

## **2.7. Discharge Route**

There is a first-order drain directly north of the lagoon which is proposed to be the discharge location. The first order drain becomes a third order drain at SW 17-8-19, and eventually converges with the Little Souris River between 10 and 11 km downstream. The Little Souris River terminates at the Assiniboine River approximately 40 km downstream from the lagoon discharge point.

Several dugouts were noted along the discharge route 0.5 km away, and a slough was noted 3.5 km away. Oakland Colony was contacted to determine

whether these sloughs were being used; they replied that the sloughs were not being used and were likely part of a natural drain system.

Figure 1: Discharge Route

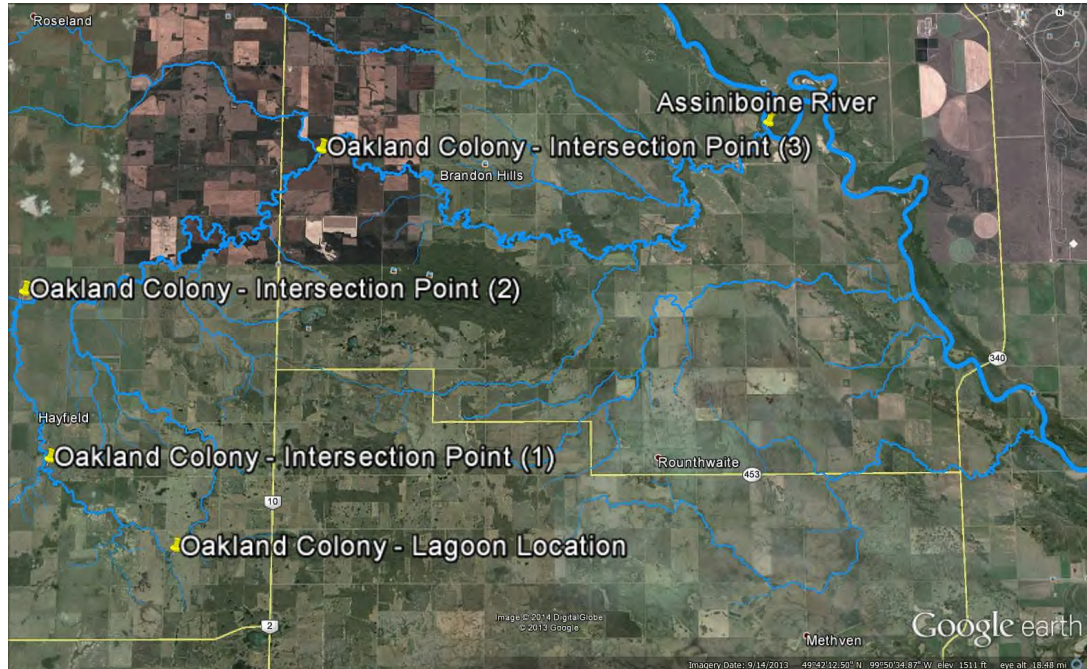

As the effluent will be discharged in accordance with Manitoba Conservation regulations, the effluent should meet discharge criteria. The stream is also expected to dilute and polish the wastewater, and plant-life should quickly absorb any excess nutrients. This will be elaborated on later in the report.

The Office of Drinking Water was contacted to determine whether there were any public water users downstream. The Office of Drinking Water confirmed that there were no public users until Portage La Prairie, far too distant to be at risk for contamination. The Office of Drinking Water stated that the Long Plain Reserve may be an unregistered user, but as they are between 15 and 20 km from Portage La Prairie, they will also be unaffected. For correspondence between the Office of Drinking Water and BMCE, refer to Appendix C.

## 2.8. Facility Operation

Wastewater effluent will be pumped out of the lift station to the lagoon, where the water will be stored until it is released in the spring and fall.

The discharge operation is summarized in the following steps:

- a) Two weeks prior to the time of sampling the valve permitting flow between the primary and secondary cell will be closed. This will ensure a representative water sample can be taken from the secondary cell.

- b) Two weeks after the valve has been closed, a water sample from the secondary cell will be obtained, using sample bottles supplied from an accredited laboratory. Water sampling and submission procedures will be performed in accordance with Manitoba Conservation and laboratory guidelines.
- c) If the water samples meet Manitoba Conservation requirements water from the secondary cell can be discharged. Water will only be discharged within the June 15 to November 1 time period. If the samples do not meet Manitoba Conservation requirements, testing will be repeated until the samples have passed the testing criteria. Additional time will allow more time for natural processes such as sunlight and settling to have an effect on the wastewater effluent quality.
- d) Once the effluent has been drained from the secondary cell, the discharge valve will be closed and the valve permitting flow between the primary and secondary cell will be opened.
- e) Once the water level between the primary and secondary cell has been equalized, the secondary cell can be drained a second time if necessary to ensure adequate capacity. In this event, the valve between the primary and secondary cell will again need to be closed for two weeks, and the secondary cell wastewater will need to be re-tested prior to discharge.

## **2.9. Seasonal Maintenance**

Regular observation of the lagoon will be undertaken by colony members to ensure that there are no malfunctions or degradation. The following tasks will be performed to ensure that the integrity of the lagoon is maintained and that it functions properly;

- Grass and other plant-life growing on the berms will be trimmed and removed as necessary to ensure that the roots do not break up the liner.
- The lagoon will be inspected for signs of wildlife. Any wildlife burrowing into the berm or otherwise causing damage will be relocated.
- Valves and drainage areas will be checked and cleared of obstructions on a regular basis.
- Snow will be cleared on the roads so that the lagoon may be accessed at any time.

### **3. Description of Pre-Development Environment**

#### **3.1. Land Use**

The current land use is cultivated farmland. Oakland Colony is actively using this land to grow crops. Zoning is currently designated as Agriculture General.

#### **3.2. Topography**

The location of the lagoon will be the top of a knoll. This will ensure that water is drained away from the lagoon, and will aid in effluent discharge.

#### **3.3. Soil Conditions**

Soil conditions commonly consisted of 100 mm of topsoil, followed by sand or silty clay. Only one test hole showed consistent clay material. Given the inconsistent and small quantities of clay, the native soils are not considered suitable for a clay liner. For detailed information on soil types and layers, refer to the geotechnical report.

#### **3.4. Groundwater**

No groundwater was observed during drilling. For more detailed information, refer to the geotechnical report in Appendix F.

#### **3.5. Protected or Endangered Species**

The Manitoba Conservation Data Centre was contacted to ensure that there were no protected or endangered species observed in the vicinity of the proposed construction site. Manitoba Conservation confirmed that no occurrences of rare or endangered species have been noted in the project area. We have enclosed their response in Appendix B.

It should also be noted that as the land use is cultivated farmland, natural native land and habitat will not be impacted by the change in land use. Additionally, prior to construction the land was inspected to confirm there was no extensive wildlife habitat.

#### **3.6. Socioeconomic Environment**

The socioeconomic environment is not a large factor in this development, as the lagoon is being constructed over active crop land. The lagoon itself is situated across the road from the colony, and is further separated by a drain. This drain will act as a natural boundary separating the lagoon from the colony itself. Oakland Colony itself will be 0.6-0.7 km from the lagoon, while the nearest neighboring residence is approximately 1.0 km away.

## **4. Description of Environmental and Human Health Effects of the Proposed Development**

### **4.1. Impact on Biophysical Environment**

#### **4.1.1. Construction**

Actual construction of the facility will involve land clearing, excavation, and construction of the lagoon itself. As the existing land use is currently cultivated farmland with no tree or bush cover, the impact on the natural terrestrial environment is expected to be minimal. Furthermore, as per correspondence with Manitoba Conservation referenced in the previous section, there are no protected or endangered species within the construction area. Also, as there is a natural drain and road separating the colony from the lagoon, directional drilling will be used to install the pipe below the drain and road.

#### **4.1.2. Operation**

Once the lagoon is constructed, no impact is expected on local groundwater. Simply put, a properly designed and functioning lagoon will not allow wastewater to be leaked into the surrounding environment except during wastewater discharge, which only occurs once wastewater has been treated to acceptable levels. Further risk is mitigated by the fact that there are no water wells within the immediate quarter section that the lagoon will be built on. There are several within the same section, but as the lagoon will be constructed according to Manitoba Conservation specifications risk will be negligible.

### **4.2. Type, Quantity and Concentration of Pollutants**

#### **4.2.1. General**

Treated effluent, tested according to the Manitoba Conservation license requirements, will be discharged into a local drain shown in Appendix D and *Figure 1*. As is commonly allowed in existing lagoon licenses, effluent will be discharged between June 16<sup>th</sup> and November 1<sup>st</sup> of any year. Effluent must be tested to determine whether it is consistent with Manitoba Conservation guidelines. Regulations for nutrient concentrations are laid out in The Water Protection Act. The Act sites Manitoba Water Quality Standards, Objectives, and Guidelines for the limits on acceptable wastewater discharge

Odor is only expected to be a factor during spring and fall turnover, as this the time when noxious gases are released. This will be mitigated by the fact that the prevailing wind should direct the odors away from the colony. Furthermore, the nearest neighboring community is 1 km away, giving time for the odor to disperse.

#### **4.2.2. Phosphorus**

The limit for phosphorus concentration for an equivalent population less than 2,000 is 1 mg/L or a demonstrated nutrient reduction strategy. Testing will be performed two weeks prior to discharge to determine whether the effluent is suitable for release. We note that the discharge route is long and contains considerable plant-life. The plant-life along the drain will uptake additional phosphorus as part of their natural processes, effectively cleansing the effluent.

If there is consistent difficulty in meeting the phosphorus concentration targets or if regulations become more conservative in the future, a more intensive nutrient reduction strategy will be implemented. Phosphorus reduction will have to include the addition aluminum sulfate (alum) to cause phosphorus to settle. Once the flocculent has settled, it can be collected off the cell bottom once the lagoon is drained. Trickle discharge is not considered a necessary step in dealing with excess phosphorus concentration in this case, as the drain only has water in it sporadically, there is extensive plant-life throughout and the discharge route is extended over a long distance before meeting any major waterway.

#### **4.2.3. Other Nutrients**

Other nutrients of concern during testing include nitrogen, total coliforms / fecal coliforms, 5-day biochemical oxygen demand, and total suspended sediment. All parameters will be tested according to the standards set out in the Manitoba Water Quality Standards, Objectives and Guidelines 2011 document. In the event that any of the tests fail, water will be re-tested according to the procedure set out in Section 2.8 Facility Operation.

### **4.3. Fish Habitat**

The Department of Fisheries and Oceans has made available on their website maps detailing fish habitat across Manitoba. The maps are part of a report published by D.W. Milani titled, "Fish community and fish habitat inventory of streams and constructed drains throughout agricultural areas of Manitoba (2002 - 2006)". We have included a map showing the Oakland Colony discharge location in Appendix D. As the map demonstrates, the discharge location is Habitat E location for 1.9 km downstream. Habitat E indicates that the habitat is unsuitable for fish, as water does not flow continuously throughout the year. At 1.9 km, several small drainage channels converge, resulting in a larger stream with indicator fish. As there is a 1.9 km distance, there is time for natural polishing processes of the stream bed to take place. The flow rate is slowed by plant-life which improves sedimentation processes and allows for increased absorption into the stream bed. This also allows for increased absorption by native plant-life. Overall, the discharge route makes use of the natural cleansing processes of streams and rivers to fully treat the effluent prior to fish being impacted.

#### **4.4. Socio-Economic, Climate Change Implications**

The existing wastewater treatment system is not sufficient to accommodate colony growth. This is therefore an important project from a socio-economic perspective, as it will benefit Oakland Colony by providing adequate wastewater treatment capacity.

As this is a small lagoon taking advantage of natural treatment processes, no significant climate change impacts are expected.

#### **4.5. Potential Impact on Human Health and Safety**

The site location is within established farmland, well away from any dwelling spaces or commercial/industrial buildings. Given the isolation of the site, it should not be considered an attractive nuisance. The smell and appearance of the lagoon should further discourage people from coming near.

The effluent discharge route was examined to determine if there were any downstream users within sufficient range to be affected. As per correspondence with the Office of Drinking Water referenced in Appendix C, there are no public downstream users until Portage La Prairie, far too distant to be at risk.

Therefore, no impact on human health and safety is expected.

### **5. Mitigation Measures and Residual Environmental Effects**

#### **5.1. Protection**

The practices to be used during construction are common to projects of a similar nature. As this facility will be built on previously cultivated farmland and will have a relatively small footprint, we anticipate that our proposed design will not adversely affect the environment. A geomembrane-lined lagoon will provide environmentally sound storage and treatment of wastewater.

A dewatering and gas-venting system will be used in this design. This will ensure that if there are any holes in the synthetic liner there will be a safeguard against large gas pockets lifting the liner above the water surface. The gas venting and liner system will be installed to run along the floor of the lagoon and directly through the berm. The system will then discharge from the outer walls of the berm.



## **5.2. Monitoring**

On-going monitoring of the lagoon will be performed to ensure the proper functioning of the lagoon. Regular inspection will ensure that there is no damage to the lagoon from erosion, failures or other causes. Further attention will be paid to odor, and if excessive odor is noticeable the cause will be identified and dealt with accordingly. The general condition of the lagoon will be observed on an ongoing basis during all seasons.



## Appendix A – Certificate of Title

DATE: 2014/02/18  
TIME: 14:58

# MANITOBA

TITLE NO: 2558479/2

POST

## STATUS OF TITLE

PAGE: 1

STATUS OF TITLE.....	ACCEPTED	PRODUCED FOR..	CORINNE R
ORIGINATING OFFICE...	BRANDON	ADDRESS.....	
REGISTERING OFFICE...	BRANDON		
REGISTRATION DATE....	2011/10/12		
COMPLETION DATE.....	2011/10/18		
		CLIENT FILE...	NA
		PRODUCED BY...	G.GISLASON

### LEGAL DESCRIPTION:

CARROLL HOLDING CO. LTD.

IS REGISTERED OWNER SUBJECT TO SUCH ENTRIES RECORDED HEREON  
IN THE FOLLOWING DESCRIBED LAND

THE S 1/2 OF SECTION 9-8-19 WPM  
 EXC FIRSTLY: OUT OF THE SE 1/4 OF SAID SECTION THE ELY 1858 FEET PERP  
 OF THE NLY 984 FEET  
 AND SECONDLY: OUT OF THE SE 1/4 THE ELY 896 FEET OF  
 THE SLY 1476 FEET IN PERP

### ACTIVE TITLE CHARGE(S):

1203835/2	ACCEPTED	CAVEAT	REG'D: 2007/06/29
	DESCRIPTION:	OPTION/WIND POWER AGRT DATED 17 AUG 2005, 5 YR TERM	
	FROM/BY:	AIM POWERGEN CORPORATION	
	TO:	CHRISTINA C VIEIRA AS AGENT	
	CONSIDERATION:	NOTES: SW 1/4 9	
1281754/2	ACCEPTED	MORTGAGE	REG'D: 2011/02/04
	FROM/BY:	FISHER BRANCH HOLDING CO. LTD.	
	TO:	ROYAL BANK OF CANADA	
	CONSIDERATION:	\$3,600,000.00	NOTES:

### ADDRESS(ES) FOR SERVICE:

EFFECT	NAME AND ADDRESS	POSTAL CODE
ACTIVE	CARROLL HOLDING CO. LTD. BOX 310 HODGSON MB	ROC 1N0

### ORIGINATING INSTRUMENT(S):

REGISTRATION NUMBER	TYPE	REG. DATE	CONSIDERATION	SWORN VALUE
1297593/2	T	2011/10/12	\$1.00	\$4,826,600.00
	PRESENTED BY:	DUBOFF, EDWARDS, HAIGHT		
	FROM:	FISHER BRANCH HOLDING CO. LTD.		
	TO:	CARROLL HOLDING CO. LTD.		

CERTIFIED TRUE EXTRACT PRODUCED FROM THE LAND TITLES DATA  
STORAGE SYSTEM ON 2014/02/18 OF TITLE NUMBER 2558479/2

\*\*\*\*\* STATUS OF TITLE 2558479/2 CONTINUED ON NEXT PAGE \*\*\*\*\*

DATE: 2014/02/18  
TIME: 14:58

# MANITOBA

## STATUS OF TITLE

TITLE NO: 2558479/2

PAGE: 2

STATUS OF TITLE..... ACCEPTED  
ORIGINATING OFFICE... BRANDON  
REGISTERING OFFICE... BRANDON  
REGISTRATION DATE.... 2011/10/12  
COMPLETION DATE..... 2011/10/18

PRODUCED FOR.. CORINNE R  
ADDRESS.....  
  
CLIENT FILE... NA  
PRODUCED BY... G.GISLASON

---

**FROM TITLE NUMBER(S):**

2509780/2 ALL

**LAND INDEX:**

LOT	QUARTER SECTION	SECTION	TOWNSHIP	RANGE
	SE	9	8	19W
NOTE:	EXC PARTS			
	SW	9	8	19W
NOTE:				

ACCEPTED THIS 12TH DAY OF OCTOBER, 2011  
BY K.GRAINGER FOR THE DISTRICT REGISTRAR OF  
THE LAND TITLES DISTRICT OF BRANDON.

CERTIFIED TRUE EXTRACT PRODUCED FROM THE LAND TITLES DATA  
STORAGE SYSTEM ON 2014/02/18 OF TITLE NUMBER 2558479/2.

\*\*\*\*\* END OF STATUS OF TITLE 2558479/2 \*\*\*\*\*



## Appendix B – Manitoba Conservation Data Centre Correspondence

FW Oakland Colony - Wastewater Lagoon.txt

From: Friesen, Chris (CWS)  
Sent: February-10-14 10:09 AM  
To: 'j.amundson@bmce.ca'  
Subject: Oakland Colony - Wastewater Lagoon

Jeff

Thank you for your information request. I completed a search of the Manitoba Conservation Data Centre's rare species database and found no occurrences at this time for your area of interest.

The information provided in this letter is based on existing data known to the Manitoba Conservation Data Centre at the time of the request. These data are dependent on the research and observations of CDC staff and others who have shared their data, and reflect our current state of knowledge. An absence of data in any particular geographic area does not necessarily mean that species or ecological communities of concern are not present; in many areas, comprehensive surveys have never been completed. Therefore, this information should be regarded neither as a final statement on the occurrence of any species of concern, nor as a substitute for on-site surveys for species as part of environmental assessments.

Because the Manitoba CDC's Biotics database is continually updated and because information requests are evaluated by type of action, any given response is only appropriate for its respective request. Please contact the Manitoba CDC for an update on this natural heritage information if more than six months pass before it is utilized.

Third party requests for products wholly or partially derived from Biotics must be approved by the Manitoba CDC before information is released. Once approved, the primary user will identify the Manitoba CDC as data contributors on any map or publication using Biotics data, as follows as: Data developed by the Manitoba Conservation Data Centre; Wildlife and Ecosystem Protection Branch, Manitoba Conservation.

This letter is for information purposes only - it does not constitute consent or approval of the proposed project or activity, nor does it negate the need for any permits or approvals required by the Province of Manitoba.

We would be interested in receiving a copy of the results of any field surveys that you may undertake, to update our database with the most current knowledge of the area.

If you have any questions or require further information please contact me directly at (204) 945- 7747.

Chris Friesen  
Biodiversity Information Manager  
Manitoba Conservation Data Centre  
204-945-7747  
chris.friesen@gov.mb.ca  
<http://www.gov.mb.ca/conservation/cdc/>

-----Original Message-----

From:  
Sent: February-07-14 9:30 AM  
To: Friesen, Chris (CWS)  
Subject: WWW Form Submission

Below is the result of your feedback form. It was submitted by WWW Information Request ( ) on Friday, February 7, 2014 at 09:30:12

---

FW Oakland Colony - Wastewater Lagoon.txt

DocumentID: Manitoba\_Conservation

Project Title: Oakland Colony - Wastewater Lagoon

Date Needed: 2014/02/24

Name: Jeff Amundson

Company/Organization: Burns Maendel Consulting Engineers Ltd.

Address: 1331 Princess Avenue

City: Brandon

Province/State: Manitoba

Phone: 1.204.728.7364

Fax: 1.204.728.4418

Email: j.amundson@bmce.ca

Project Description: We are looking to design a wastewater treatment lagoon on behalf of Oakland Colony. The information will be included in an EAP to indicate impact on the local environment.

Information Requested: We would like to be aware of any protected or endangered species in the listed quarter section.

Format Requested: PDF format would be preferred; if PDF format is not available, Microsoft Word would be the next best option.

Location: The site is approximately 17 km south of Brandon. The legal description of the site is SW 9-8-19 WPM.

action: Submit

---



## Appendix C – Office of Drinking Water Correspondence



**From:** Robertson, Glen (CWS) [Glen.Robertson@gov.mb.ca]  
**Sent:** Tuesday, February 18, 2014 2:39 PM  
**To:** Jeff Amundson  
**Subject:** RE: Oakland Colony - Downstream Users

Hello Jeff.

In response to your email, I have reviewed the attached map and the first know public water system downstream of the proposed lagoon would be the City of Portage la Prairie. To my knowledge there are no other semi-public or public water systems using the surface water between your proposed lagoon and Portage la Prairie. However, there is the Long Plain Reserve just before Portage la Prairie that is a Federal facility and not regulated by us that may use the surface water. This is something you may want to into.

Glen Robertson  
Senior Drinking Water Officer  
Manitoba Conservation and Water Stewardship  
1129 Queens Avenue  
Brandon MB R7A 1L9  
phone: (204)726-6563  
fax: (204)726-6567

[www.manitoba.ca/drinkingwater](http://www.manitoba.ca/drinkingwater)

---

**From:** Jeff Amundson [<mailto:j.amundson@bmce.ca>]  
**Sent:** February-10-14 11:10 AM  
**To:** Robertson, Glen (CWS)  
**Cc:** Daniel Burns  
**Subject:** Oakland Colony - Downstream Users

Hello Glen,

We are currently working on an EAP for a wastewater stabilization pond on behalf of Oakland Colony, located at SW 9-8-19 WPM. The effluent discharge location would be a local drain, which would eventually join the Little Souris River, and later the Assiniboine River. We are looking to identify any downstream users within approximately 2 km of the discharge point. Would you be able to provide us with this information? If not, do you know who we would be able to contact?

I have attached a map of the proposed discharge route. Intersection Point (1) is located approximately 2 km downstream of the discharge location.

If you have any questions or need additional clarification, please do not hesitate to contact me.

Regards,

Jeff Amundson, E-I-T  
Junior Engineer



1331 Princess Avenue

Brandon, MB R7A 0R4

Tel: 204.728.7364

Fax: 204.728.4418

[j.amundson@bmce.ca](mailto:j.amundson@bmce.ca)

*The contents of this email and attachments are intended for the individual or entity to which it is addressed. Any reproductions or disclosure of the contents in this email other than by the intended recipient(s) is unauthorized and may be illegal. If you have received this message in error, please notify the sender by reply email. Thank you.*





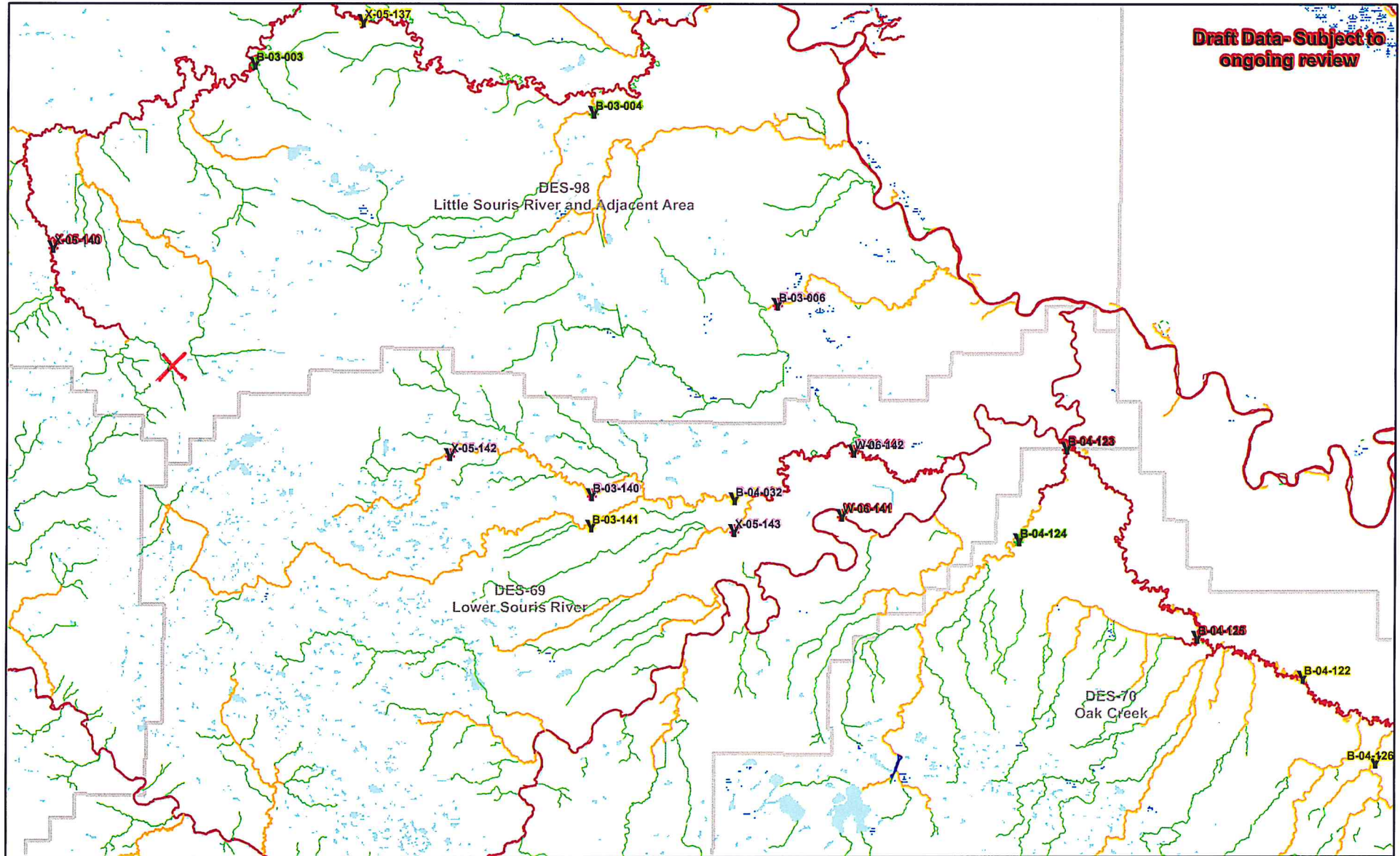

## Appendix D – Fish Habitat Map

**Draft Data- Subject to ongoing review**







062F16	062G13	062G14
062F09	062G12	062G11
062F08	062G05	062G06

**Habitat Classification**

- A 
- B 
- C 
- D 
- E 

**Fishing Results**

- Indicator Species 
- Non-Indicator Species 
- No Catch 
- No Fishing Effort 

**Appendix 9**  
**Sampling sites, fish captures and habitat classification of streams and constructed drains throughout agricultural areas of Manitoba (2002 – 2006)**

**062G12**

Produced April 2012



## Appendix E – Drawing Package

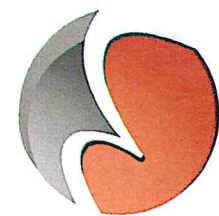

**BURNS MAENDEL**  
CONSULTING ENGINEERS LTD.

1331 Princess Ave.  
Brandon, Manitoba R7A 0R4  
Tel: (204) 728-7364  
Fax: (204) 728-4418

# OAKLAND COLONY DOMESTIC LAGOON

R.M. of OAKLAND

## CIVIL DRAWINGS

DWG NO.	DRAWING NAME	REV
C1.1	LAGOON SITING PLAN	B
C1.2	LOCATION PLAN AND SITE PLAN	C
C1.3	LAGOON PLAN VIEW	C
C2.1	CROSS SECTIONS	B
C2.2	SECTIONS AND DETAILS	B
C2.3	FENCING AND SIGNAGE	B

DATE

MARCH 18, 2014

PROJECT NO:

BMCE-13-119:50

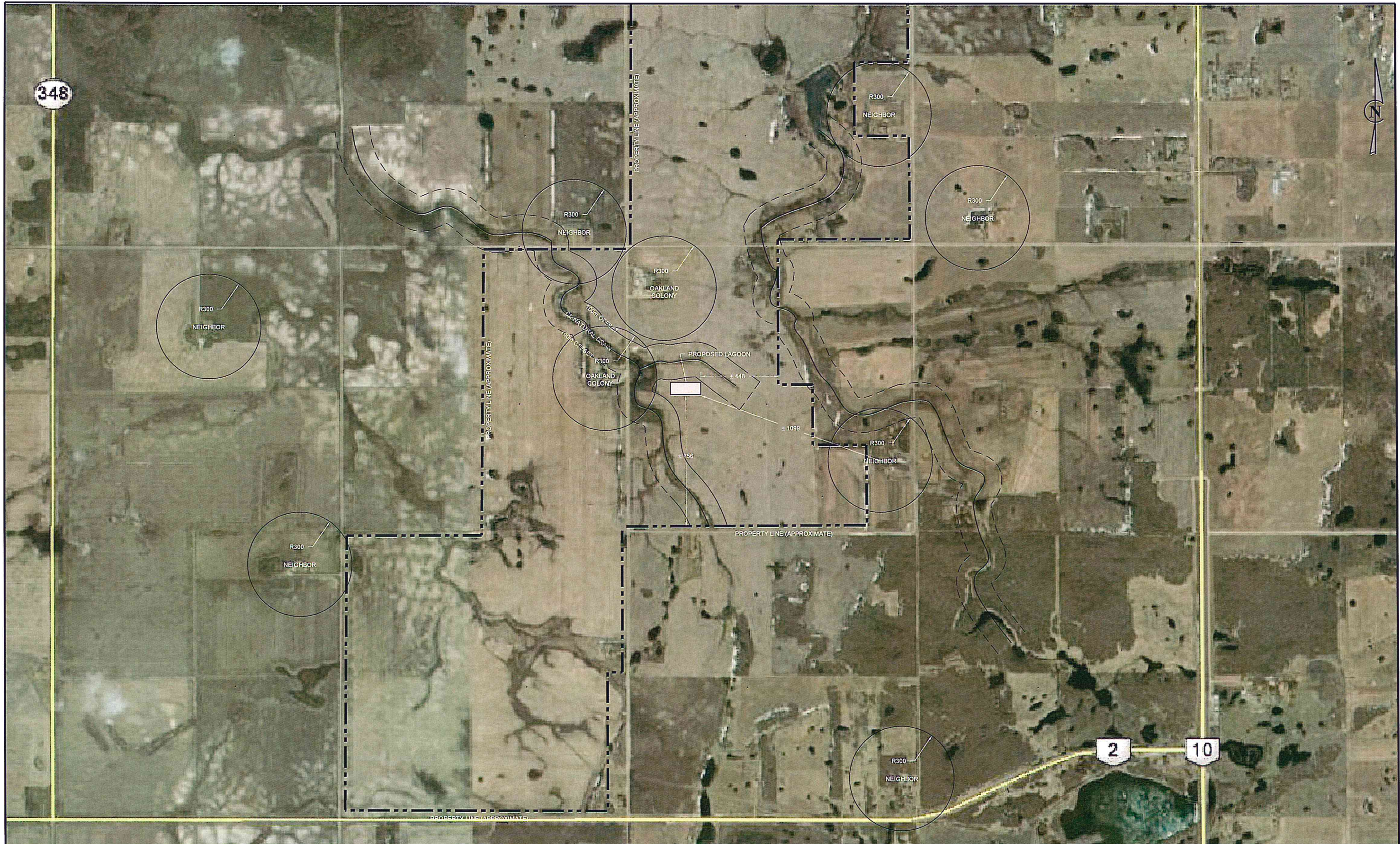

ISSUED FOR CLIENT REVIEW AND COMMENT				
A	MARCH 13, 2014	DAB	CR	
NO.	DATE	APP.	BY	DESCRIPTION
REVISIONS				

DESIGNED BY: J.A.	REVIEWED BY: D.A.B.
DRAWN BY: C.R.	
PROJECT START DATE: OCT. 1, 2013	
PLOT SIZE: A1 (594x841)	
SCALE: 1:10,000	

PROJECT NAME:  
**OAKLAND COLONY  
COMMUNITY DEVELOPMENT  
R.M. OF OAKLAND**



1331 Princess Ave.  
Brandon, Manitoba  
R7A 0R4  
Tel: (204) 728-7364  
Fax: (204) 728-4418

DRAWING TITLE: <b>LAGOON SITING PLAN</b>	
PROJECT NUMBER: BMCE-13-119:50	DRAWING NO.: C1.1

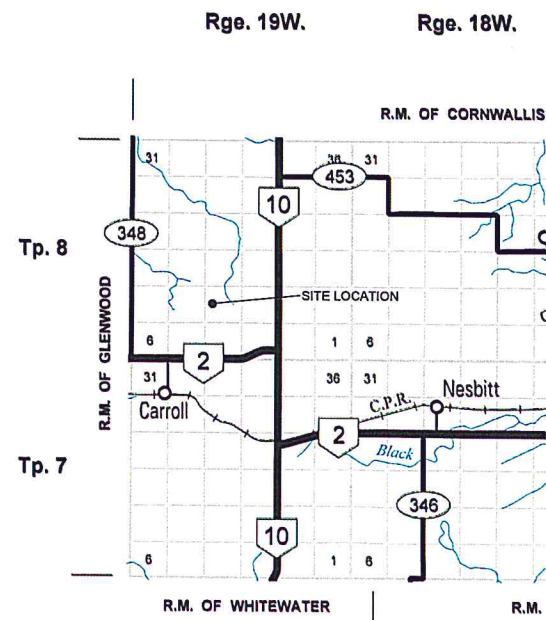

**LOCATION PLAN**  
SCALE: N.T.S.

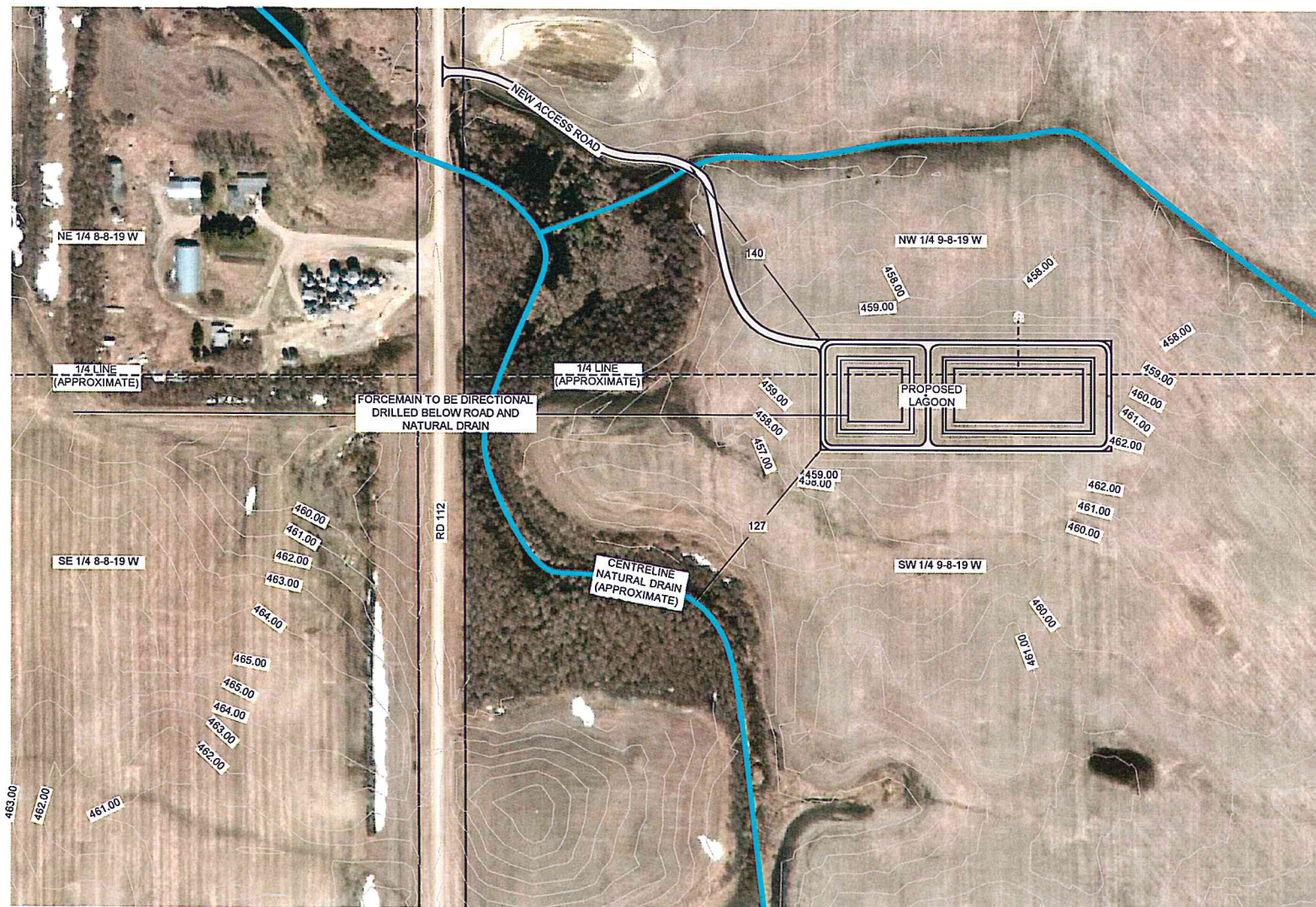

**LAGOON SITE PLAN**  
SCALE: 1:2000

NO.	DATE	APP.	BY	DESCRIPTION
C	MARCH 18, 2014	DAB	CR	ISSUED FOR ENVIRONMENTAL ACT PROPOSAL
B	MARCH 13, 2014	DAB	CR	ISSUED FOR CLIENT REVIEW AND COMMENT
A	JAN 23, 2014	J.A.	C.R.	ISSUED FOR INFORMATION
REVISIONS				

**APEGM**  
Certificate of Authorization  
Burns Maendel Consulting  
Engineers Ltd.  
No. 4559 Expiry: April 30, 2014

*[Signature]*  
D.A. BURNS  
MEMBER  
21508  
REGISTERED PROFESSIONAL ENGINEER  
18-Mar-2014

DESIGNED BY: J.A.  
REVIEWED BY: D.A.B.  
DRAWN BY: C.R.  
PROJECT START DATE: JAN. 17, 2014  
PLOT SIZE: A1 (594x841)  
SCALE: AS NOTED

PROJECT NAME:  
**OAKLAND COLONY  
DOMESTIC LAGOON  
R.M. OF OAKLAND**

**BURNS MAENDEL  
CONSULTING ENGINEERS LTD.**

1331 Princess Ave.  
Brandon, Manitoba  
R7A 0R4  
Tel: (204) 728-7364  
Fax: (204) 728-4418

DRAWING TITLE:  
**LOCATION PLAN AND  
LAGOON SITE PLAN**

PROJECT NUMBER: **BMCE-13-119:50**  
DRAWING NO: **C1.2**



**LAGOON DESIGN PARAMETERS:**

DETENTION TIME: 230 DAYS  
 LOADING RATE: 275 LITRES / PERSON / DAY  
 POPULATION: 150 PEOPLE  
 ORGANIC LOADING: 0.077kg BOD5 / PERSON / DAY  
 ORGANIC LOADING / AREA: 56 kg BOD5 / (HA\*DAY)

**LAGOON GEOMETRIC PARAMETERS:**

CELL HEIGHT: 1.50 m  
 FREEBOARD: 1.00 m  
 INTERIOR SIDE SLOPE: 5:1  
 EXTERIOR SIDE SLOPE: 5:1  
 DEAD SPACE: 0.15 m

**KEYNOTES**

- 1. 1800 x 1800 x 150mm THICK CONCRETE INLET PAD c/w 200mm HIGH CURB.
- 2. 1800 x 1800 x 150mm THICK CONCRETE SPLASH PAD c/w 200mm HIGH CURB. SEE DETAIL.
- 3. WICK VAPOUR DRAIN AND DEWATERING SYSTEM TO BE INSTALLED DIRECTLY UNDER THE LINER AND SPACED @ 6m o/c.
- 4. Ø150mm EQUALIZATION PIPE.
- 5. GATE VALVE.

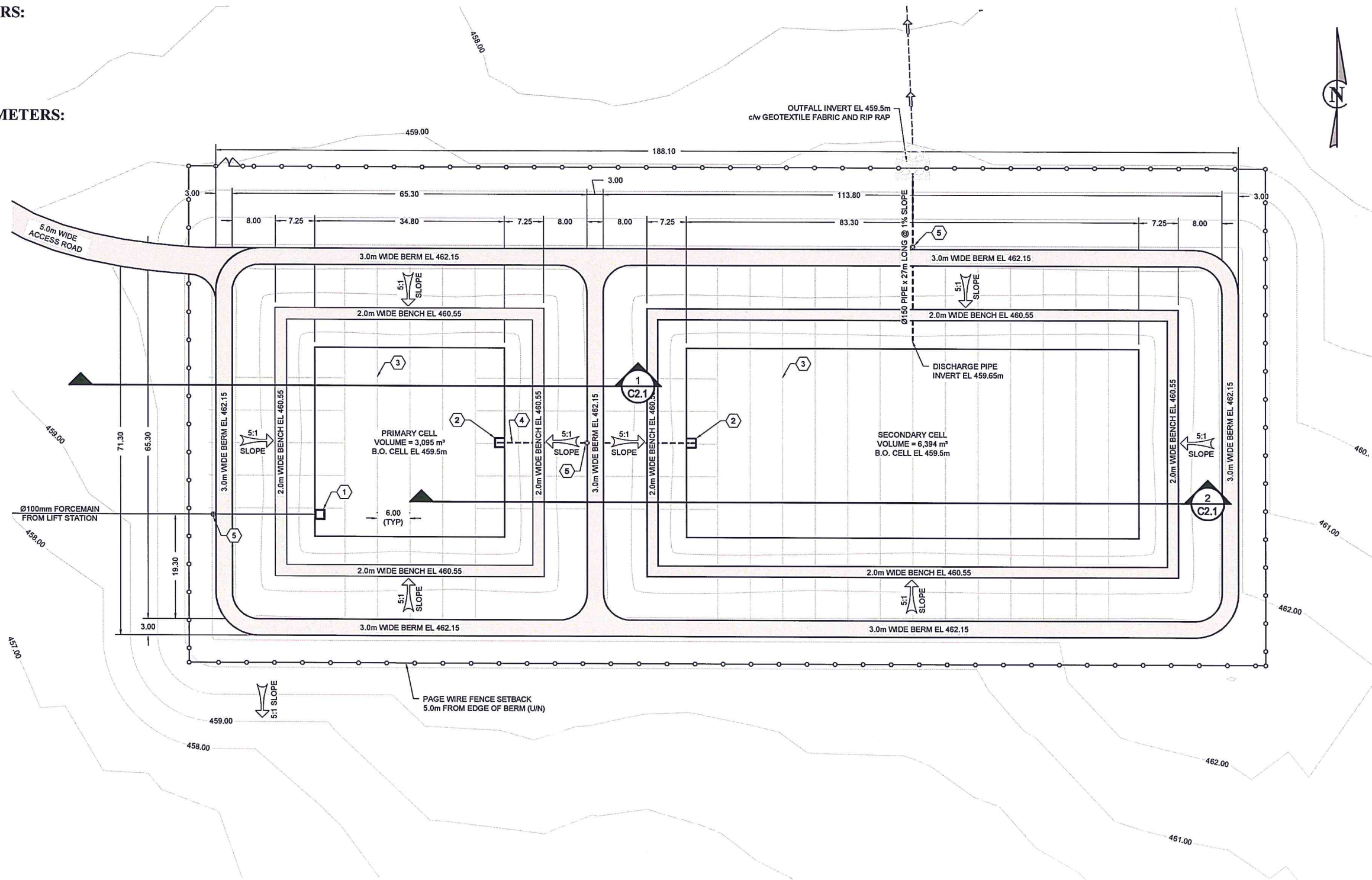

**LAGOON PLAN VIEW**  
 SCALE: 1:400

NO.	DATE	APP.	BY	DESCRIPTION
C	MARCH 16, 2014	DAB	CR	ISSUED FOR ENVIRONMENTAL ACT PROPOSAL
B	MARCH 13, 2014	DAB	CR	ISSUED FOR CLIENT REVIEW AND COMMENT
A	JAN 23, 2014	J.A.	C.R.	ISSUED FOR INFORMATION
REVISIONS				

**APEG**  
 Certificate of Authorization  
 Burns Maendel Consulting Engineers Ltd.  
 No. 4559 Expiry: April 30, 2014



DESIGNED BY: J.A.  
 REVIEWED BY: D.A.B.  
 DRAWN BY: C.R.  
 PROJECT START DATE: JAN. 17, 2014  
 PLOT SIZE: A1 (594x841)  
 SCALE: AS NOTED

PROJECT NAME:  
**OAKLAND COLONY DOMESTIC LAGOON R.M. OF OAKLAND**

1331 Princess Ave.  
 Brandon, Manitoba R7A 0R4  
**BURNS MAENDEL CONSULTING ENGINEERS LTD.**  
 Tel: (204) 728-7364  
 Fax: (204) 728-4418

DRAWING TITLE:  
**LAGOON PLAN VIEW**

PROJECT NUMBER: **BMCE-13-119:50**  
 DRAWING NO.: **C1.3**

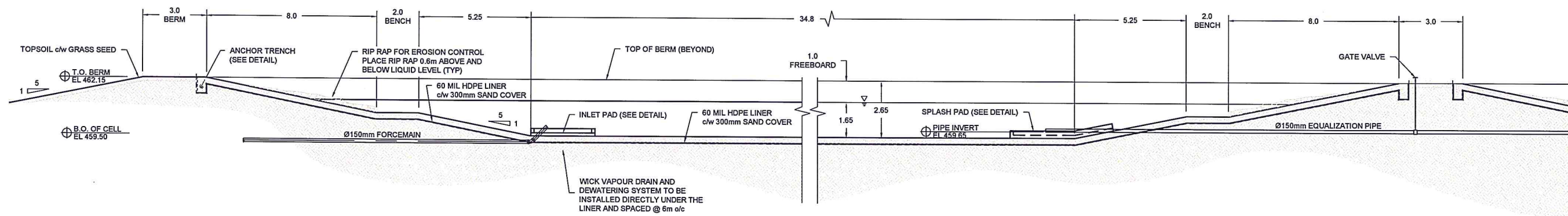

**1 PRIMARY CELL SECTION**  
 C1.2 SCALE: 1:100

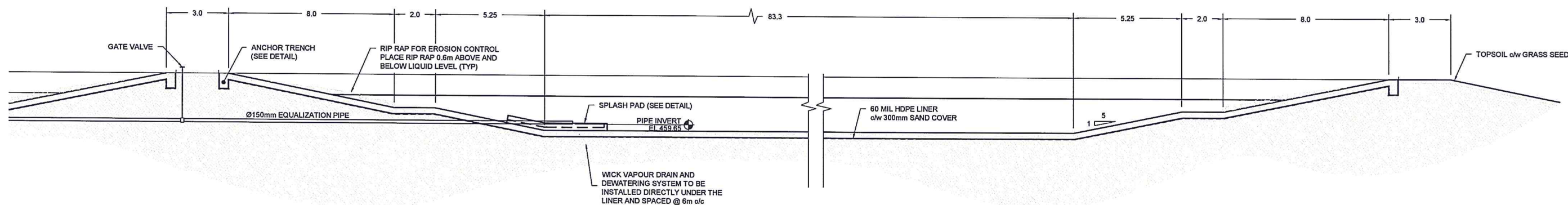

**2 SECONDARY CELL SECTION**  
 C1.2 SCALE: 1:100

NO:	DATE	APP.	BY	DESCRIPTION
B	MARCH 18, 2014	DAB	CR	ISSUED FOR ENVIRONMENTAL ACT PROPOSAL
A	MARCH 13, 2014	DAB	CR	ISSUED FOR CLIENT REVIEW AND COMMENT

REVISIONS

**APEGN**  
 Certificate of Authorization  
 Burns Maendel Consulting  
 Engineers Ltd.  
 No. 4559 Expiry: April 30, 2014



DESIGNED BY: J.A.  
 REVIEWED BY: D.A.B.  
 DRAWN BY: C.R.  
 PROJECT START DATE: FEB. 12, 2014  
 PLOT SIZE: A1 (594x841)  
 SCALE: AS NOTED

PROJECT NAME:  
**OAKLAND COLONY  
 DOMESTIC LAGOON  
 R.M. OF OAKLAND**

**BURNS MAENDEL**  
 CONSULTING ENGINEERS LTD.

1331 Princess Ave.  
 Brandon, Manitoba  
 R7A 0R4  
 Tel: (204) 728-7364  
 Fax: (204) 728-4418

DRAWING TITLE:  
**LAGOON CROSS SECTIONS**

PROJECT NUMBER: **BMCE-13-119:50**  
 DRAWING NO: **C2.1**

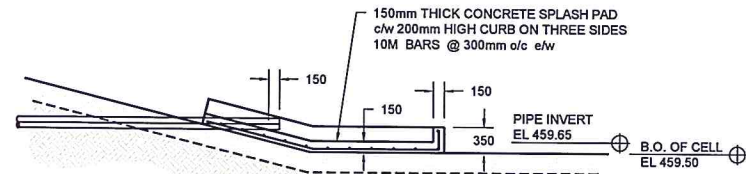

**TYPICAL SPLASH PAD - SECTION**  
SCALE: 1:50

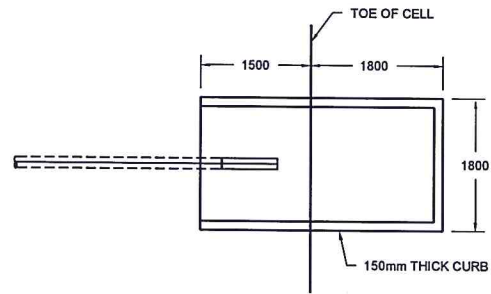

**TYPICAL SPLASH PAD - PLAN VIEW**  
SCALE: 1:50

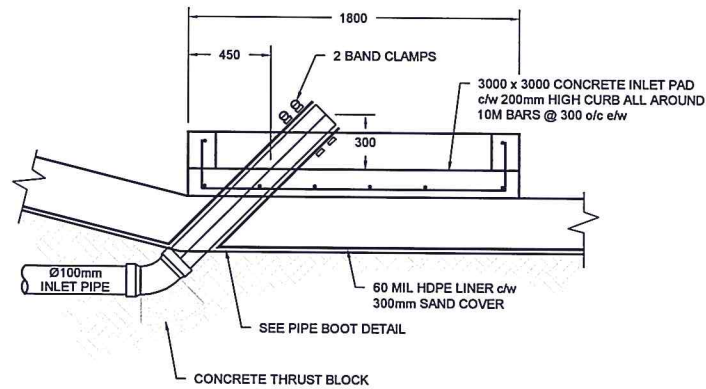

**INLET PAD DETAIL**  
SCALE: 1:20

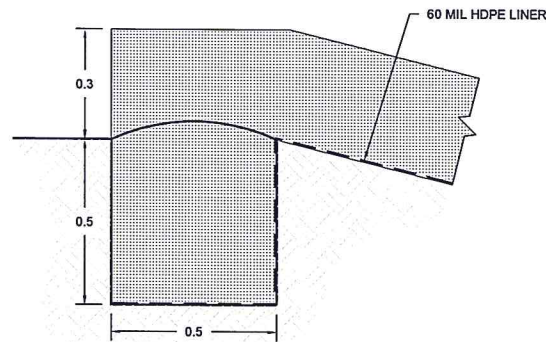

**LINER ANCHOR DETAIL**  
SCALE: 1:10

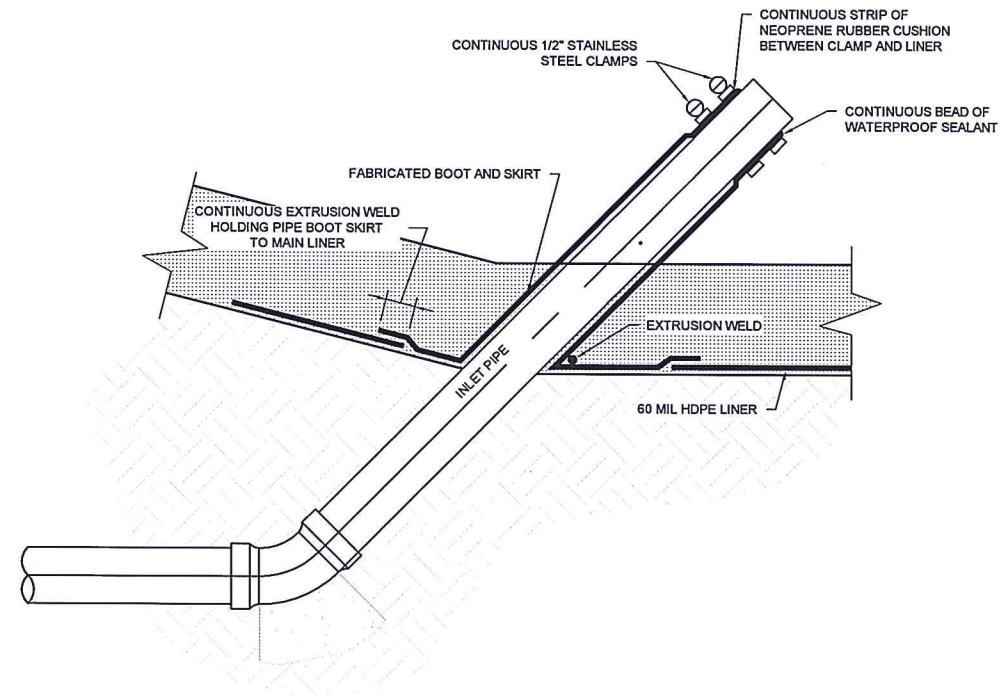

**PIPE BOOT DETAIL**  
SCALE: 1:10

- (1) GRADE
- (2) DUCTILE IRON UPPER SECTION
- (3) 50mm SQUARE OPERATING NUT
- (4) STONE DISC.
- (5) ADJUSTABLE VALVE BOX
- (6) PVC or DUCTILE IRON LOWER SECTION
- (7) MINIMUM 50mm SQUARE EXTENSION SPINDLE
- (8) VALVE BOX TO BE PROTECTED AGAINST LATERAL MOVEMENT DURING BACKFILL
- (9) AWWA C500 or C509 GATE VALVE WITH JOINTS COMPATIBLE TO PIPE BEING USED. (FLANGED & PUSH ON ARE SHOWN)
- (10) GASKET
- (11) THRUST BLOCK SHALL BE CAST IN PLACE BETWEEN GATE VALVE AND UNDISTURBED SOIL. MIN 450W X 450L X 150H.
- (12) DUCTILE IRON COVER

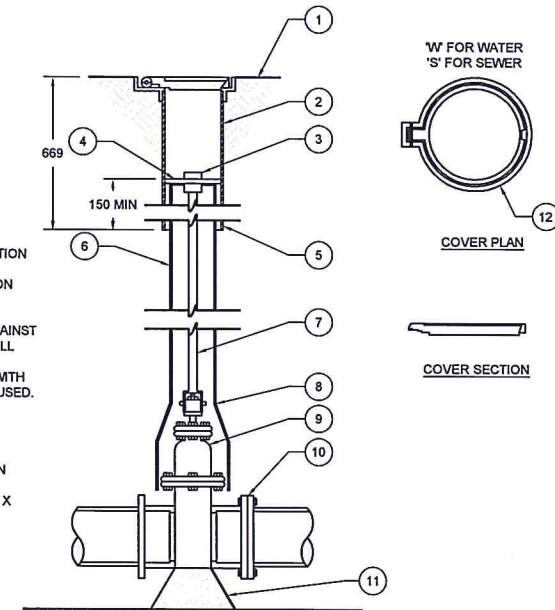

**GATE VALVE DETAIL**  
SCALE: 1:10

NO.	DATE	APP.	BY	DESCRIPTION
B	MARCH 18, 2014	DAB	CR	ISSUED FOR ENVIRONMENTAL ACT PROPOSAL
A	MARCH 13, 2014	DAB	CR	ISSUED FOR CLIENT REVIEW AND COMMENT
REVISIONS				

**MAPEGN**  
Certificate of Authorization  
Burns Maendel Consulting  
Engineers Ltd.  
No. 4559 Expiry: April 30, 2014

**D.A. BURNS**  
REGISTERED PROFESSIONAL ENGINEER  
MEMBER 21508  
18-Mar-2014

DESIGNED BY: J.A.  
REVIEWED BY: D.A.B.  
DRAWN BY: C.R.  
PROJECT START DATE: FEB. 12, 2014  
PLOT SIZE: A1 (594x841)  
SCALE: AS NOTED

PROJECT NAME:  
**OAKLAND COLONY  
DOMESTIC LAGOON  
R.M. OF OAKLAND**

**BURNS MAENDEL**  
CONSULTING ENGINEERS LTD.  
1331 Princess Ave.  
Brandon, Manitoba  
R7A 0R4  
Tel: (204) 728-7364  
Fax: (204) 728-4418

DRAWING TITLE:  
**SECTIONS AND DETAILS**

PROJECT NUMBER: **BMCE-13-119:50**  
DRAWING NO: **C2.2**

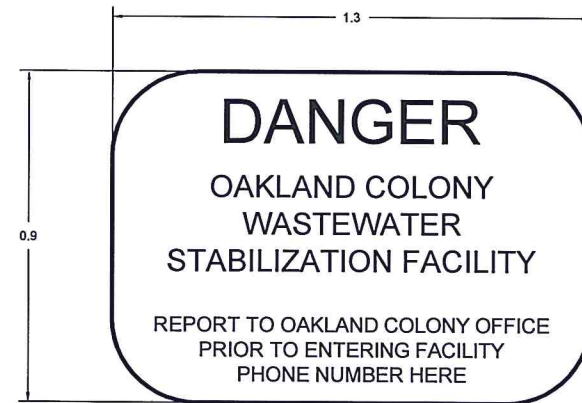

- NOTES:
- 1) MAIN ENTRANCE SIGNAGE TO BE ATTACHED AND INSTALLED WITH TWO 4x4 PRESSURE TREATED WOOD POSTS.
  - 2) SIGN TO BE CONSTRUCTED OF ALUMINUM AIR MASTER QUALITY OR APPROVED EQUAL.



- NOTES:
- 1) PERIMETER SIGNAGE TO BE SECURED TO PERIMETER FENCE POSTS EVERY 50m AROUND ENTIRE FACILITY.
  - 2) SIGNS TO BE CONSTRUCTED OF ALUMINUM AIR MASTER QUALITY OR APPROVED EQUAL.

**SIGNAGE DETAILS**  
SCALE: 1:10

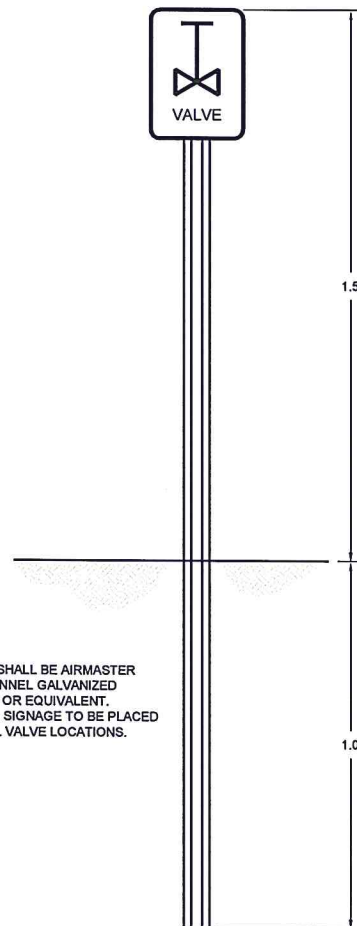

- NOTES:
- 1) POST SHALL BE AIRMASTER U-CHANNEL GALVANIZED STEEL OR EQUIVALENT.
  - 2) VALVE SIGNAGE TO BE PLACED AT ALL VALVE LOCATIONS.

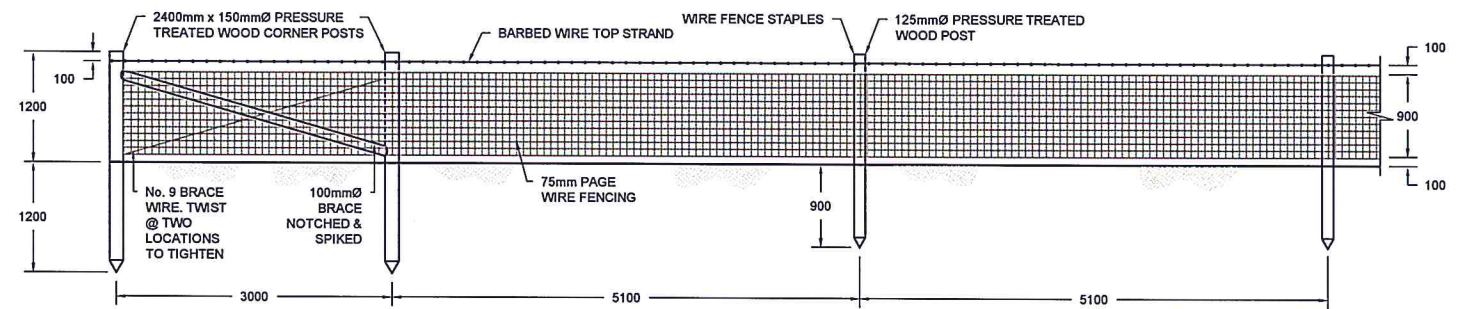

**PAGE WIRE FENCE DETAIL**  
SCALE: N.T.S.

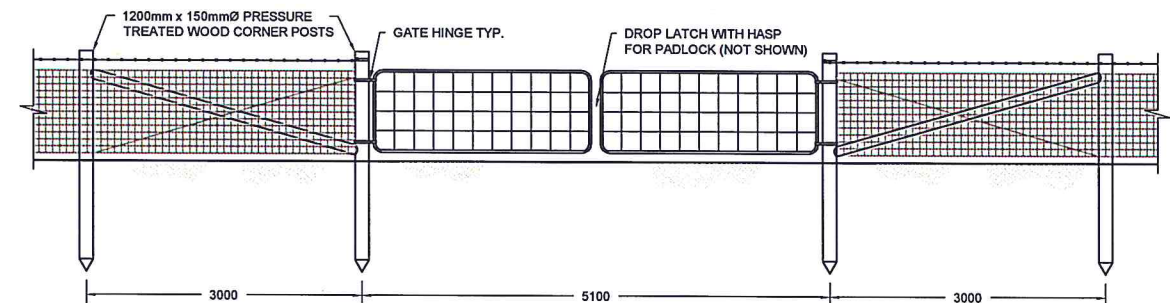

**PAGE WIRE FENCE GATE DETAIL**  
SCALE: N.T.S.

NO.	DATE	APP.	BY	DESCRIPTION
B	MARCH 18, 2014	DAB	CR	ISSUED FOR ENVIRONMENTAL ACT PROPOSAL
A	MARCH 13, 2014	DAB	CR	ISSUED FOR CLIENT REVIEW AND COMMENT
REVISIONS				



DESIGNED BY: J.A.  
REVIEWED BY: D.A.B.  
DRAWN BY: C.R.  
PROJECT START DATE: FEB. 12, 2014  
PLOT SIZE: A1 (594x841)  
SCALE: AS NOTED

PROJECT NAME: OAKLAND COLONY DOMESTIC LAGOON R.M. OF OAKLAND  
1331 Princess Ave. Brandon, Manitoba R7A 0R4  
**BURNS MAENDEL** CONSULTING ENGINEERS LTD.  
Tel: (204) 728-7364 Fax: (204) 728-4418

DRAWING TITLE: FENCING AND SIGNAGE  
PROJECT NUMBER: BMCE-13-119:50  
DRAWING NO: C2.3



## Appendix F – Geotechnical Report

Submitted To:

**Burns Maendel Consulting**

**SOIL ASSESSMENT**

**PROPOSED LAGOON  
OAKLAND COLONY, MANITOBA**



**FEBRUARY 2014**

**FILE NO. 14-398-01**



***“Engineering and Testing Solutions That Work for You”***

6 - 854 Marion Street  
Winnipeg, Manitoba  
Canada  
R2J 0K4

Phone: (204) 233-1694  
Facsimile: (204) 235-1579  
e-mail: [eng\\_tech@mts.net](mailto:eng_tech@mts.net)  
[www.eng-tech.ca](http://www.eng-tech.ca)

**TABLE OF CONTENTS**

	<b>PAGE</b>
<b>TABLE OF CONTENTS .....</b>	<b>i</b>
<b>1.0 INTRODUCTION .....</b>	<b>1</b>
1.1 Scope of Work .....	1
<b>2.0 TEST HOLE DRILLING, SOIL SAMPLING, LABORATORY TESTING .....</b>	<b>1</b>
<b>3.0 STRATIGRAPHY .....</b>	<b>1</b>
<b>4.0 RESULTS AND COMMENTS .....</b>	<b>2</b>
<b>5.0 CLOSURE .....</b>	<b>2</b>

**Attachments**

- Figure 1 – General Site Location Plan
- Figure 2 – Site Location Plan
- Figure 3 – Test Hole Location Plan
- Modified Unified Classification System for Soils
- Stratigraphic Test Hole Logs (5)
- Particle Size Analysis Reports (5)

## **1.0 INTRODUCTION**

ENG-TECH Consulting Limited (ENG-TECH) completed the requested soil assessment for the proposed construction of a lagoon at the above location. The purpose of the investigation was to assess the soil stratigraphy and conduct tests on select soil samples in order to provide comments on the suitability of the soils for construction of a lagoon.

### **1.1 Scope of Work**

ENG-TECH completed the following scope of work:

- A test hole drilling and soil sampling program within the proposed lagoon.
- A laboratory testing program.
- An engineering report outlining the investigation and comments.

## **2.0 TEST HOLE DRILLING, SOIL SAMPLING, LABORATORY TESTING**

ENG-TECH supervised the drilling of five (5) test holes (TH1 to TH5) on January 28, 2014 at the locations shown on Figures 1 to 3. TH1 and TH5 were drilled to 9.0 m below grade, whereas TH2 to TH4 were drilled to 3.0 m below grade, using a track mounted RM-30 drill rig equipped with 125 mm diameter solid stem continuous flight augers owned and operated by Paddock Drilling Ltd. All test holes were backfilled using the auger cuttings and bentonite upon the completion of drilling.

The soil stratigraphy was visually classified at the time of drilling using the modified Unified Soil Classification System (USCS). All soil samples collected were retained for testing in ENG-TECH's Winnipeg laboratory.

Moisture contents were determined on all soil samples collected (30), while two (2) Atterberg Limit tests and five (5) particle size distributions were completed on select samples. The results of the moisture contents and Atterberg Limit tests are shown on the test hole summary logs, whereas the particle size distributions are shown on individual reports.

## **3.0 STRATIGRAPHY**

The stratigraphy at the site consisted of a thin layer of topsoil underlain by sand, followed by silty clay to the depth explored. Except at TH2 where a clay layer was encountered at depth from 0.2 m to 1.8 m below grade. The silty clay was medium to dark brown, moist, soft, medium to low plastic, and contained trace sand and silt. The sand layer was medium brown, damp, loose, poorly graded, and contained trace silt, trace to some clay with depth. The clay was dark brown, moist, stiff, medium plastic, and contained trace sand with silt. Frost extended to approximately 0.6 m below grade at the time of drilling.

Sloughing was encountered from within the sand layers at TH1 and TH5, while no water seepage was encountered during drilling. Detailed stratigraphy descriptions are outlined on the test hole summary logs.



#### 4.0 RESULTS AND COMMENTS

The particle size analysis shows the silty clay layer normally has well over 50% silt with a clay content between 10% and 25%, whereas the highly plastic clay layer has less than 40% silt and over 60% clay. Atterberg Limit tests completed on two (2) samples were consistent, with an average Liquid Limit, Plastic Limit, and Plasticity Index of 35, 20 and 15%, respectively.

Hydraulic conductivity testing was not conducted on select samples since the soil in the proposed lagoon location contained high percentages of silt and fine grained sand. The hydraulic conductivity of this silty clay soil in their natural state are not expected to meet Manitoba Conservation's hydraulic conductivity requirement of  $1 \times 10^{-7}$  cm/sec for lagoons.

The use of the silty clay to construct the lagoon liner is possible, although construction difficulties will occur, and select portions of the silty clay will not be useable when the silt and sand content increase. Close monitoring of the soil during construction will be required. The silty clay will also require compaction to a higher percent dry density than what is used for higher plastic clays, and compaction will also be difficult because silty clays with high silt content are sensitive to moisture. Laboratory testing of remolded samples should be completed before construction to establish a suitable field density value based on the test results.

The other option for this site would be to excavate the lagoon followed by the placement of a liner. This option will eliminate the need for hard compaction of the silty clay, which will limit difficulties during construction and ensure compliance with Manitoba Conservation.

#### 5.0 CLOSURE

ENG-TECH trusts this is all the information you require. If you have any questions or require additional information, please contact the undersigned.

Sincerely,  
ENG-TECH Consulting Limited



Clark Hryhoruk, M.Sc., P.Eng.  
Principal, Geotechnical, Engineer

CDH/wg



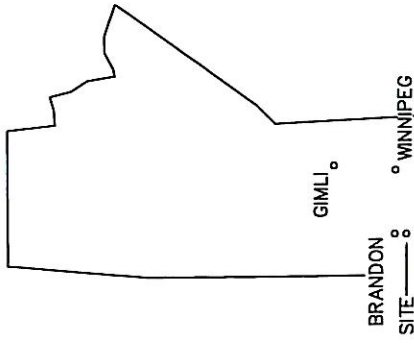

NO.	DATE	ISSUE / REVISION
01	Jan 29/14	report

6 - 854 Marion Street  
 Winnipeg, MB R2J 0K4  
 Phone: (204) 233-1694  
 Fax: (204) 235-1579



ENG. STAMP:



CLIENT:

BURNS MAENDEL CONSULTING

PROJECT:

SOIL ASSESSMENT,  
 PROPOSED LAGOON,  
 OAKLAND COLONY, MANITOBA

DWG DESCRIPTION:

GENERAL SITE LOCATION PLAN

SCALE:

AS SHOWN

DRAWN BY:

WG

DATE:

JANUARY 2014

FILE No.:

14-398-01



CLIENT DWG/FIG. No.:

ENG-TECH DWG/FIG. No.:

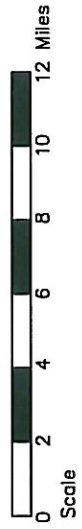
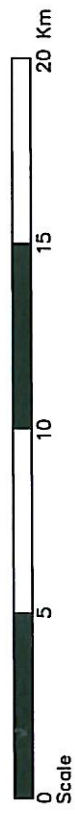
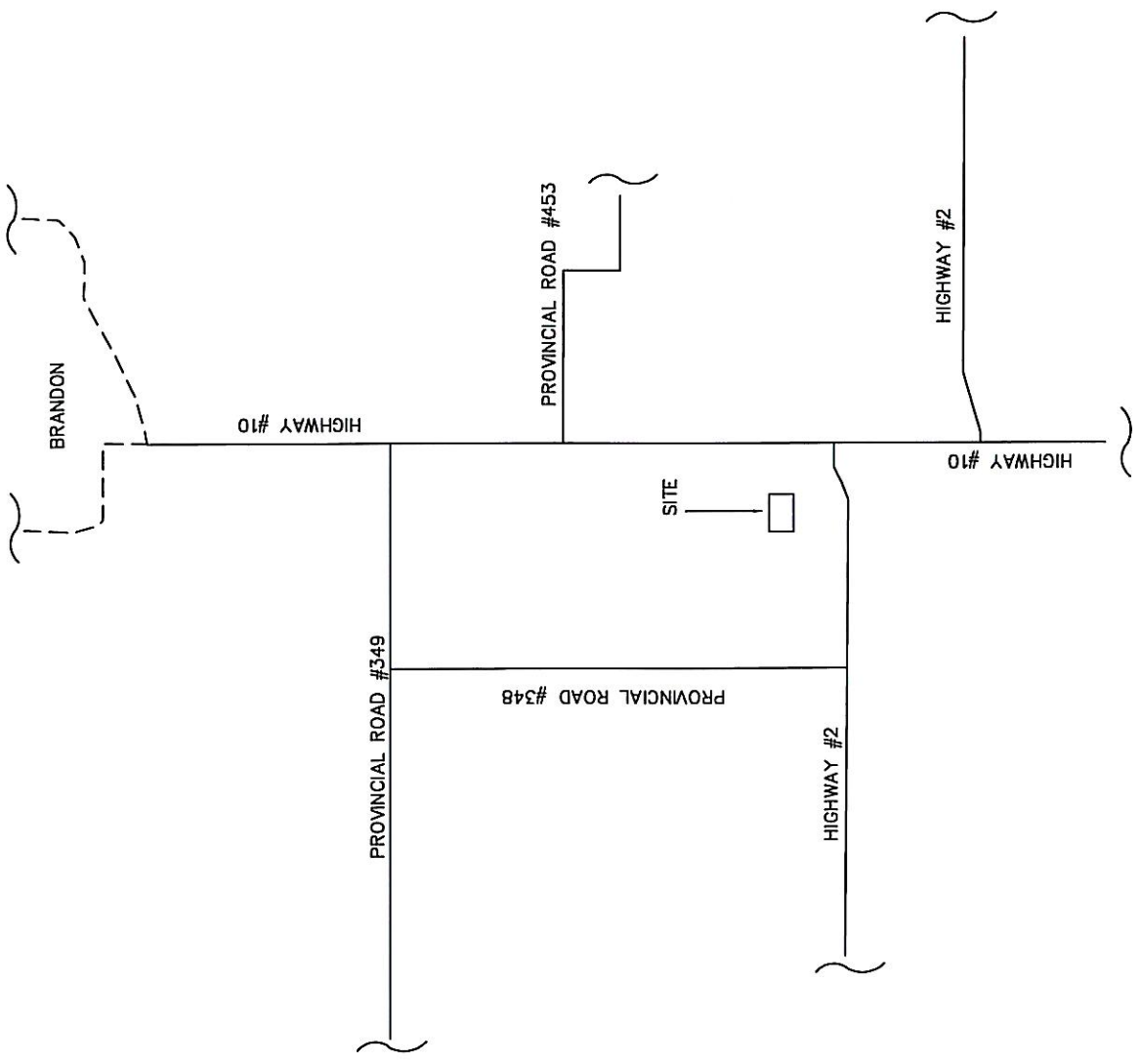
1

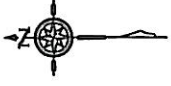



NO.	DATE	ISSUE / REVISION
01	Jan 29/14	report
 <p>6 - 654 Marion Street Winnipeg, MB R2J 0K4 Phone: (204) 233-1684 Fax: (204) 235-1579</p>		
 <p>Certificate of Authorization ENG-TECH Consulting Limited No. 2475 Expiry: April 30, 2014</p>		
<b>CLIENT:</b> BURNS MAENDEL CONSULTING		
<b>PROJECT:</b> SOIL ASSESSMENT, PROPOSED LAGOON, OAKLAND COLONY, MANITOBA		
<b>DWG DESCRIPTION:</b> SITE LOCATION PLAN		
<b>SCALE:</b> AS SHOWN		
<b>DRAWN BY:</b>	<b>DATE:</b>	<b>CLIENT DWG/FIG. No.:</b>
WG		
<b>FILE No.:</b>	<b>ENG-TECH DWG/FIG. No.:</b>	<b>NO.:</b>
14-398-01		2

GPS COORDINATES OF TEST HOLES		
TEST HOLE No.	UTM	14U
TH 1	5499303	427718
TH 2	5499356	427723
TH 3	5499338	427656
TH 4	5499316	427579
TH 5	5499369	427584

**LEGEND**

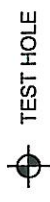

TEST HOLE

NO.	DATE	ISSUE / REVISION
01	Jan 29/14	report

**ENG-TECH CONSULTING LIMITED**  
 6 - 654 Marion Street  
 Winnipeg, MB R2J 0K4  
 Phone: (204) 233-1694  
 Fax: (204) 235-1579

**APCM**  
 Certificate of Authorization  
 ENG-TECH Consulting Limited  
 No. 2475 Expiry: April 30, 2014

CLIENT: BURNS MAENDEL CONSULTING  
 PROJECT: SOIL ASSESSMENT, PROPOSED LAGOON, OAKLAND COLONY, MANITOBA  
 DWG DESCRIPTION: TEST HOLE LOCATION PLAN  
 SCALE: AS SHOWN  
 DRAWN BY: WG  
 DATE:  
 FILE No.: 14-398-01  
 CLIENT DWG/FIG. No.:  
 ENG-TECH DWG/FIG. No.:  
 NO.: 3

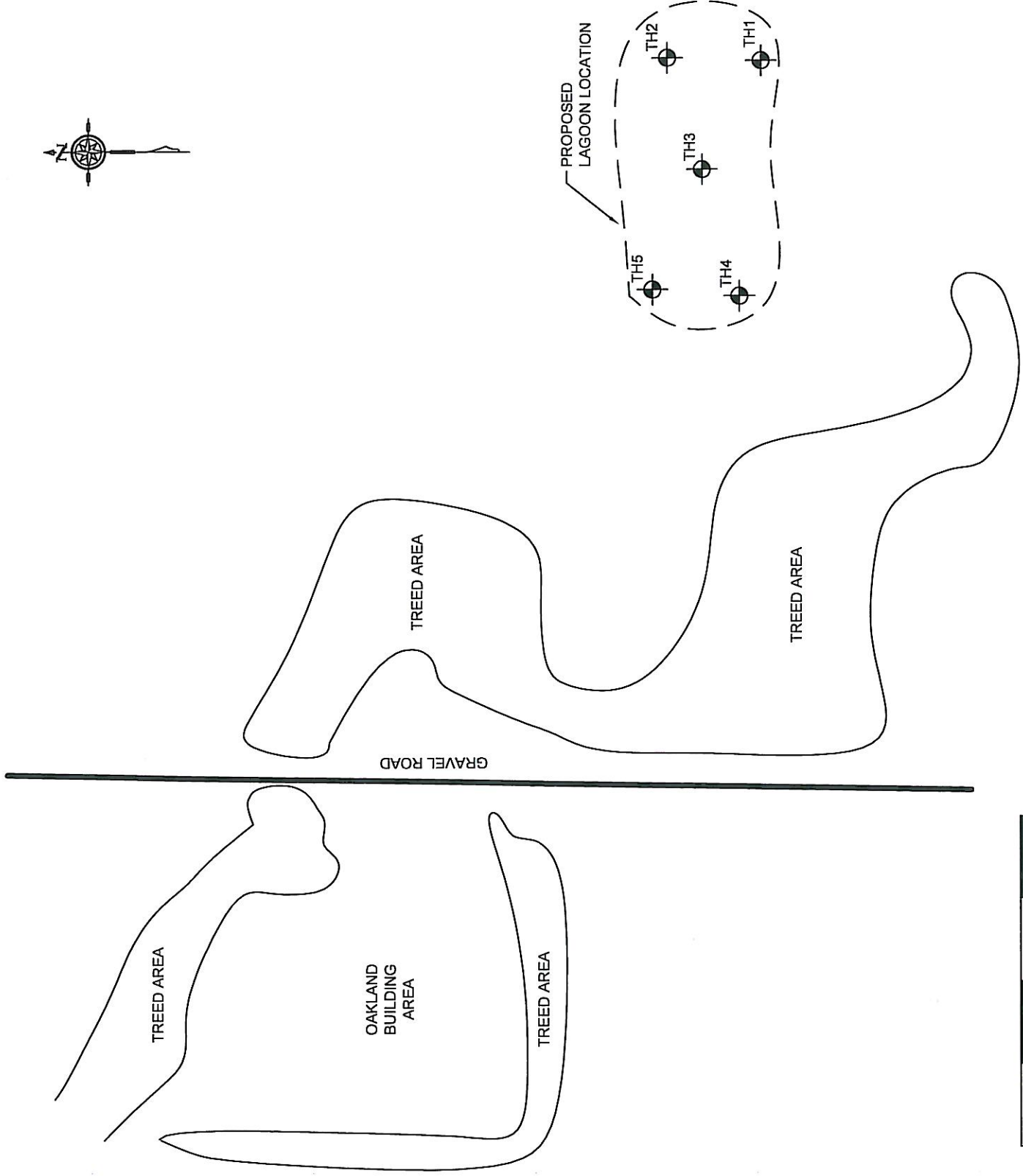
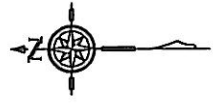

MODIFIED UNIFIED CLASSIFICATION SYSTEM FOR SOILS

MAJOR DIVISION			GROUP SYMBOL	GRAPH SYMBOL	TYPICAL DESCRIPTION	LABORATORY CLASSIFICATION CRITERIA		
COARSE GRAINED SOILS (MORE THAN HALF BY WEIGHT LARGER THAN 75 µm)	GRAVELS MORE THAN HALF THE COARSE FRACTION LARGER THAN 4.75 mm	CLEAN GRAVELS (TRACE OR NO FINES)	GW		WELL GRADED GRAVELS, GRAVEL-SAND MIXTURES, LITTLE OR NO FINES	$C_u = \frac{D_{60}}{D_{10}} > 4$ ; $C_c = \frac{(D_{30})^2}{D_{10} \times D_{60}} = 1 \text{ TO } 3$		
			GP		POORLY GRADED GRAVELS, GRAVEL-SAND MIXTURES, LITTLE OR NO FINES	NOT MEETING ABOVE REQUIREMENTS		
		DIRTY GRAVELS (WITH SOME OR MORE FINES)	GM		SILTY GRAVELS, GRAVEL-SAND-SILT MIXTURES	ATTERBERG LIMITS BELOW "A" LINE OR P.I. LESS THAN 4		
			GC		CLAYEY GRAVELS, GRAVEL-SAND-CLAY MIXTURES	ATTERBERG LIMITS ABOVE "A" LINE AND P.I. MORE THAN 7		
	SANDS MORE THAN HALF THE COARSE FRACTION SMALLER THAN 4.75 mm	CLEAN SANDS (TRACE OR NO FINES)	SW		WELL GRADED SANDS, GRAVELLY SANDS, LITTLE OR NO FINES	$C_u = \frac{D_{60}}{D_{10}} > 6$ ; $C_c = \frac{(D_{30})^2}{D_{10} \times D_{60}} = 1 \text{ TO } 3$		
			SP		POORLY GRADED SANDS, GRAVELLY SANDS, LITTLE OR NO FINES	NOT MEETING ABOVE REQUIREMENTS		
		DIRTY SANDS (WITH SOME OR MORE FINES)	SM		SILTY SANDS, SAND-SILT MIXTURES	ATTERBERG LIMITS BELOW "A" LINE OR P.I. LESS THAN 4		
			SC		CLAYEY SANDS, SAND-CLAY MIXTURES	ATTERBERG LIMITS ABOVE "A" LINE AND P.I. MORE THAN 7		
		FINE GRAINED SOILS (MORE THAN HALF BY WEIGHT SMALLER THAN 75 µm)	SILTS BELOW "A" LINE NEGLECTIBLE ORGANIC CONTENT	LL ≤ 50%	ML		INORGANIC SILTS AND VERY FINE SANDS, ROCK FLOUR, SILTY SANDS OF SLIGHTY PLASTICITY	CLASSIFICATION IS BASED UPON PLASTICITY CHART (SEE BELOW)
				LL > 50%	MH		INORGANIC SILTS, MICACEOUS OR DIATOMACEOUS, FINE SANDY OR SILTY SOILS	
CLAYS ABOVE "A" LINE NEGLECTIBLE ORGANIC CONTENT	LL ≤ 30%		CL		INORGANIC CLAYS OF LOW PLASTICITY, GRAVELLY, SANDY OR SILTY CLAYS, LEAN CLAYS			
	30% < LL ≤ 50%		CI		INORGANIC CLAYS OF MEDIUM PLASTICITY, SILTY CLAYS			
	LL > 50%		CH		INORGANIC CLAYS OF HIGH PLASTICITY, FAT CLAYS			
ORGANIC SILTS & CLAYS BELOW "A" LINE	LL < 50%		OL		ORGANIC SILTS AND ORGANIC SILTY CLAYS OF LOW PLASTICITY			
	LL > 50%		OH		ORGANIC CLAYS OF HIGH PLASTICITY			
HIGHLY ORGANIC SOILS			PI		PEAT AND OTHER HIGHLY ORGANIC SOILS	STRONG COLOUR OR ODOUR, AND OFTEN FIBROUS TEXTURE		

ADDITIONAL SYMBOLS		
TILL		SANDSTONE
FILL		GRANITE
TOPSOIL		
CONCRETE		
SHALE		
LIMESTONE		

PLASTIC SOILS					
MOISTURE	PLASTICITY	INTRUSIONS	CONSISTENCY	POCKET PEN (TSF)	(N)
DRY	LOW	ROOTLETS	VERY SOFT		< 2
DAMP	MEDIUM	OXIDES	SOFT	0 - 0.5	2 - 4
MOIST	HIGH	MICA	FIRM	0.5 - 1.0	4 - 8
WET		GYPSUM	STIFF	1.0 - 2.0	8 - 15
		ETC.	VERY STIFF	2.0 - 4.0	15 - 30
			HARD	> 4.0	> 30

TSF x 95.8 = kPa (q<sub>u</sub>)      S<sub>u</sub> = 1/2 x q<sub>u</sub>

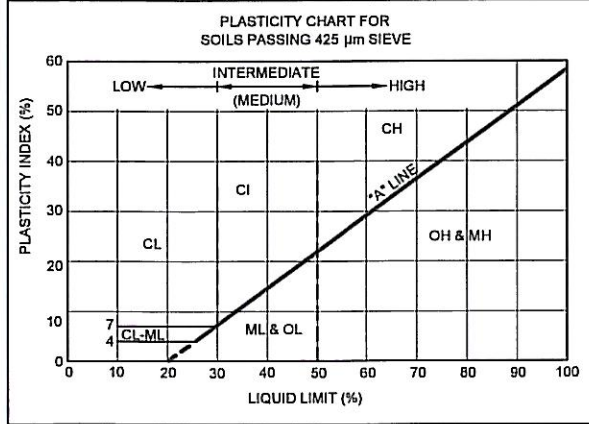

SOIL DESCRIPTIONS		
TRACE: 0 - 10%	BOULDERS: > 200 mm	COARSE SAND: 2 - 4.75 mm
SOME: 10 - 20%	COBBLES: 75 - 200 mm	MEDIUM SAND: 0.425 - 2 mm
WITH: 20 - 35%	COURSE GRAVEL: 19 - 75 mm	FINE SAND: 0.075 - 0.425 mm
AND: 35 - 50%	FINE GRAVEL: 4.75 - 75 mm	FINES: < 0.075 mm

GRANULAR SOILS				
MOISTURE	DENSITY	GRADATION	INTRUSIONS	SPT (N)
DRY	VERY LOOSE	POORLY	ROOTLETS	0 - 4
DAMP	LOOSE	WELL	OXIDES	4 - 10
MOIST	MED. DENSE		MICA	10 - 30
WET	DENSE		FINES	30 - 50
	VERY DENSE		ETC.	> 50

**DEFINITIONS**  
 LL = LIQUID LIMIT      C<sub>c</sub> = COMPRESSION INDEX  
 P.I. = PLASTICITY INDEX      PL = PLASTIC LIMIT  
 C<sub>u</sub> = COEFFICIENT OF UNIFORMITY  
 q<sub>u</sub> = UNCONFINED COMPRESSIVE STRENGTH  
 S<sub>u</sub> = UNDRAINED SHEAR STRENGTH

6 - 854 Marion Street  
 Winnipeg, MB R2J 0K4  
 Phone: (204) 233-1694  
 Fax: (204) 235-1579



**Engineering And Testing  
Solutions That Work For You**

**Test Hole #: TH1**

**Client:** Burns Maendel Consulting

**Site:** See Figure 1

**Location:** Oakland, Brandon, Manitoba

**Project:** Soil Assessment, Proposed Lagoon, Oakland, Manitoba

**File No.:** 14-398-01

**Date Drilled:** January 28, 2014

**Grade Elevation:** 100.0 m

**Water Elevation:** -

SUBSURFACE PROFILE			SAMPLE DATA				SHEAR STRENGTH (kPa)					
Depth (m)	Soil Symbol	Description	Elevation (m)	Sample No.	Sample Type	Moisture Content (%)	Blows/300 mm	Moisture Content (%)				
								PL	X	LL	P. Pen	Torvane
0.0		Ground Surface	100.0									
0.0 - 0.1		<b>Topsoil (100 mm)</b> - black, frozen, grass covered.										
0.1 - 1.0		<b>Sand (SP)</b> - medium brown, damp, frozen, poorly graded, trace silt.										
1.0 - 9.0		<b>Silty Clay (CL-CI)</b> - medium to dark brown, moist, soft, low to medium plastic, trace sand, and silt.										
0.8			99.0	S1	SHELBY TUBE	11.2						
1.0			99.0	S2	SHELBY TUBE	24.6						
1.8			98.0	S2A	SHELBY TUBE					24		
2.0			98.0	S3	SHELBY TUBE	12.9						
2.8			97.0	S4	SHELBY TUBE	18.9						
3.0			97.0	S4A	SHELBY TUBE							
3.8			96.0	S5	SHELBY TUBE	25.3						
4.0			96.0	S6	SHELBY TUBE	26.4					24	
6.0			94.0	S7	SHELBY TUBE	26.0					24	
8.0			92.0	S8	SHELBY TUBE	27.2						
9.0			91.0	S9	SHELBY TUBE	28.6						
9.0		<b>End of test hole</b> - end of test hole at 9.0 m. - frozen to 0.61 m below grade. - test hole opened to 6.7 m below grade. - no water was observed during the drilling, and sloughing occurred in the sand layer. - test hole was backfilled with auger cuttings and bentonite upon completion of drilling.										

ENG-TECH Consulting Limited

Logged by: W.G

Reviewed by: *W.G*

Drilled By: Paddock Drilling Ltd.

Drill Rig: RM-30

Auger Size: 125 mm solid stem

Completion Depth: 9.0 m

Completion Elevation: 91.0 m

Sheet: 1 of 1

SAMPLE TYPE



SPLIT BARREL



SHELBY TUBE



AUGER CUTTINGS



SPLIT SPOON



**Engineering And Testing  
Solutions That Work For You**

**Test Hole #: TH2**

**Client:** Burns Maendel Consulting

**Site:** See Figure 1

**Location:** Oakland, Brandon, Manitoba

**Project:** Soil Assessment, Proposed Lagoon, Oakland, Manitoba

**File No.:** 14-398-01

**Date Drilled:** January 28, 2014

**Grade Elevation:** 100.0 m

**Water Elevation:** -

SUBSURFACE PROFILE				SAMPLE DATA				SHEAR STRENGTH (kPa)					
Depth (m)	Soil Symbol	Description	Elevation (m)	Sample No.	Sample Type	Moisture Content (%)	Blows/300 mm	Moisture Content (%)					
								PL	X	LL	P. Pen	Torvane	UC
0.0		Ground Surface <b>Topsoil (100 mm)</b> - black, frozen, grass covered.	100.0										
		<b>Silty Clay (CL-CI)</b> - medium to dark brown, moist, frozen, medium to low plastic, trace to some sand, and clay.		S1		22.4							
1.0		<b>Clay (CH)</b> - medium brown, moist, stiff, high plastic, trace sand, with silt.	99.0										
		<b>Silty Clay (CL-CI)</b> - medium brown, moist, firm to soft, medium to low plastic, trace sand, and silt.		S2		31.7							
2.0		<b>Silty Clay (CL-CI)</b> - medium brown, moist, firm to soft, medium to low plastic, trace sand, and silt.	98.0										
		<b>Silty Clay (CL-CI)</b> - medium brown, moist, firm to soft, medium to low plastic, trace sand, and silt.		S3		32.0							
3.0		<b>End of test hole</b> - end of test hole at 3.0 m. - frozen to 0.61 m below grade. - no water and sloughing were observed during drilling. - test hole was backfilled with auger cuttings and bentonite upon completion of drilling.	97.0										
		<b>End of test hole</b> - end of test hole at 3.0 m. - frozen to 0.61 m below grade. - no water and sloughing were observed during drilling. - test hole was backfilled with auger cuttings and bentonite upon completion of drilling.		S4		25.0							
4.0			96.0										

ENG-TECH Consulting Limited

Logged by: W.G

Reviewed by:

Drilled By: Paddock Drilling Ltd.

Drill Rig: RM-30

Auger Size: 125 mm solid stem

Completion Depth: 3.0 m

Completion Elevation: 97.0 m

Sheet: 1 of 1

SAMPLE TYPE



SPLIT BARREL



SHELBY TUBE



AUGER CUTTINGS



SPLIT SPOON



**Engineering And Testing  
Solutions That Work For You**

**Test Hole #: TH3**

**Client:** Burns Maendel Consulting

**Site:** See Figure 1

**Location:** Oakland, Brandon, Manitoba

**Project:** Soil Assessment, Proposed Lagoon, Oakland, Manitoba

**File No.:** 14-398-01

**Date Drilled:** January 28, 2014

**Grade Elevation:** 100.0 m

**Water Elevation:** -

SUBSURFACE PROFILE				SAMPLE DATA				SHEAR STRENGTH (kPa)		
Depth (m)	Soil Symbol	Description	Elevation (m)	Sample No.	Sample Type	Moisture Content (%)	Blows/300 mm	Moisture Content (%)		
								P. Pen	Torvane	UC
0.0		<p><b>Ground Surface</b>  <b>Topsoil (100 mm)</b>                      - black, frozen, grass covered.</p> <p><b>Clay (CI)</b>                      - dark brown, moist, frozen, medium plastic, trace to some silt.</p>	100.0							
1.0			99.0	S1		27.1				
2.0		<p><b>Sand (SP)</b>                      - medium brown, damp, loose, poorly graded, trace to some silt, trace clay.</p>	98.0	S2		26.4				
3.0			97.0	S3		13.4				
4.0		<p><b>End of test hole</b>                      - end of test hole at 3.0 m.                      - frozen to 0.61 m below grade.                      - no water and sloughing were observed during drilling.                      - test hole was backfilled with auger cuttings and bentonite upon completion of drilling.</p>	96.0	S4		8.1				

ENG-TECH Consulting Limited

Logged by: W.G

Reviewed by: *CA*

Drilled By: Paddock Drilling Ltd.

Drill Rig: RM-30

Auger Size: 125 mm solid stem

Completion Depth: 3.0 m

Completion Elevation: 97.0 m

Sheet: 1 of 1

SAMPLE TYPE



SPLIT BARREL



SHELBY TUBE



AUGER CUTTINGS



SPLIT SPOON





**Engineering And Testing  
Solutions That Work For You**

**Test Hole #: TH4**

**Client:** Burns Maendel Consulting

**Site:** See Figure 1

**Location:** Oakland, Brandon, Manitoba

**Project:** Soil Assessment, Proposed Lagoon, Oakland, Manitoba

**File No.:** 14-398-01

**Date Drilled:** January 28, 2014

**Grade Elevation:** 100.0 m

**Water Elevation:** -

SUBSURFACE PROFILE				SAMPLE DATA				SHEAR STRENGTH (kPa)				
Depth (m)	Soil Symbol	Description	Elevation (m)	Sample No.	Sample Type	Moisture Content (%)	Blows/300 mm	Moisture Content (%)				
								PL	X	LL	P. Pen	Torvane
0.0		Ground Surface <b>Topsoil (100 mm)</b> - black, frozen, grass covered.	100.0									
		<b>Sand (SP)</b> - dark to medium brown, damp frozen, poorly graded, trace to some silt, trace clay.										
0.9			99.0	S1		15.4						
1.9			98.0	S2		10.6						
2.9		<b>Silty Clay (CL-CI)</b> - light to medium brown, moist, firm, low to medium plastic, trace sand, and silt.	98.0	S3		25.4						
3.1		<b>End of test hole</b> - end of test hole at 3.1 m. - frozen to 0.61 m below grade. - no water and sloughing were observed during drilling. - test hole was backfilled with auger cuttings and bentonite upon completion of drilling.	97.0	S4		26.3						
4.0			96.0									

ENG-TECH Consulting Limited

Logged by: W.G

Reviewed by:

Drilled By: Paddock Drilling Ltd.

Drill Rig: RM-30

Auger Size: 125 mm solid stem

Completion Depth: 3.1 m

Completion Elevation: 96.9 m

Sheet: 1 of 1

SAMPLE TYPE



SPLIT BARREL



SHELBY TUBE



AUGER CUTTINGS



SPLIT SPOON



**Engineering And Testing  
Solutions That Work For You**

**Test Hole #: TH5**

**Client:** Burns Maendel Consulting

**Site:** See Figure 1

**Location:** Oakland, Brandon, Manitoba

**Project:** Soil Assessment, Proposed Lagoon, Oakland, Manitoba

**File No.:** 14-398-01

**Date Drilled:** January 28, 2014

**Grade Elevation:** 100.0 m

**Water Elevation:** -

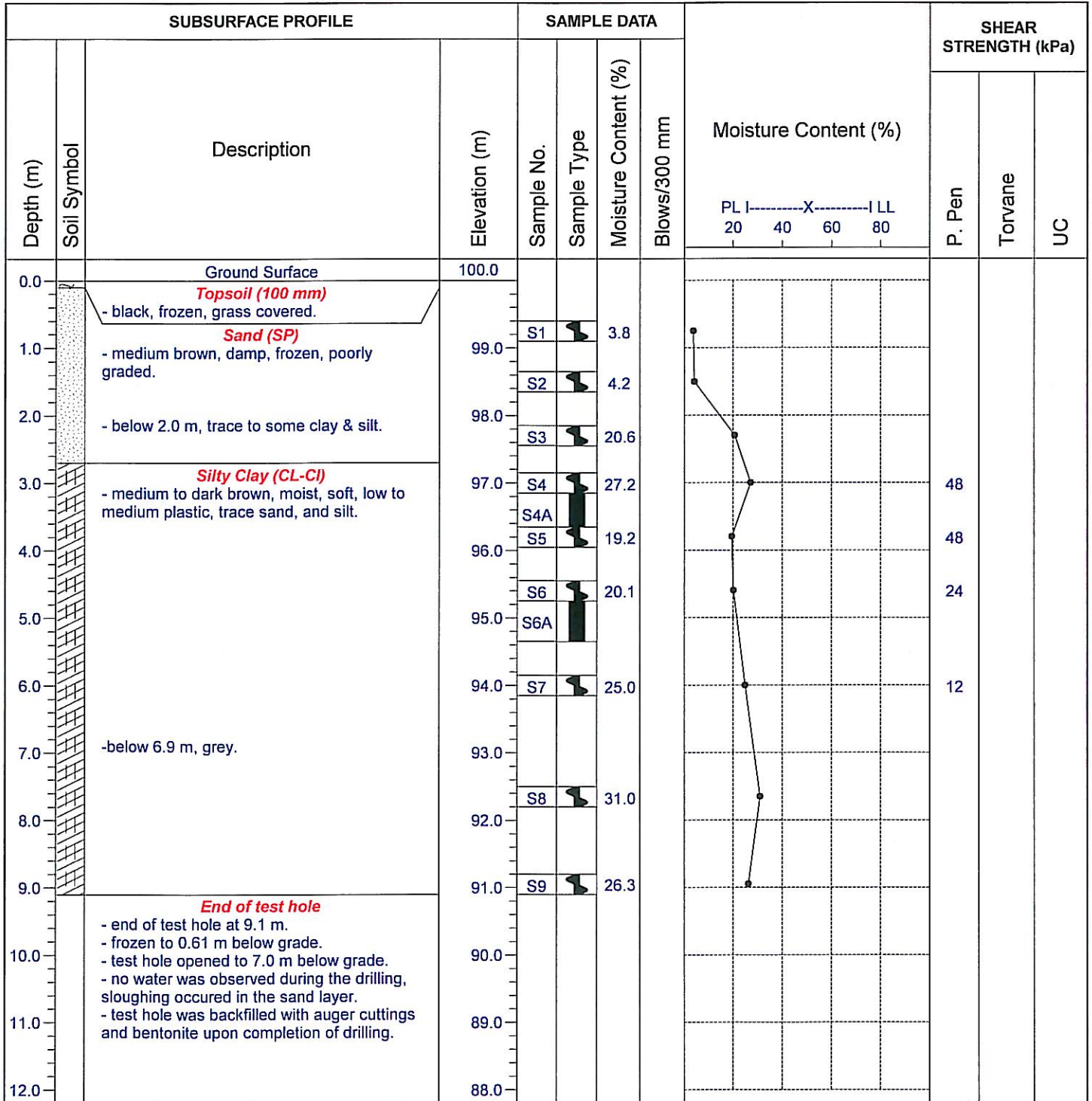

ENG-TECH Consulting Limited

Logged by: W.G

Reviewed by: *CA*

Drilled By: Paddock Drilling Ltd.

Drill Rig: RM-30

Auger Size: 125 mm solid stem

Completion Depth: 9.1 m

Completion Elevation: 90.9 m

Sheet: 1 of 1

SAMPLE TYPE



SPLIT BARREL



SHELBY TUBE



AUGER CUTTINGS



SPLIT SPOON



Unit 6 - 854 Marion Street  
 Winnipeg, Manitoba  
 R2J 0K4  
 eng\_tech@mts.net  
 www.eng-tech.ca

**PARTICLE SIZE  
 ANALYSIS REPORT**

Bruns Maendel Constluting Engineers Ltd.  
 1331 Princess Avenue  
 Brandon, Manitoba  
 R7A 0R4

**File No.:** 14-398-01  
**Ref. No.:** 14-398-1-1

**ATTENTION:** Jeff Amundson, E.I.T.

**PROJECT:** SOIL ASSESSMENT, PROPOSED LAGOON, OAKLAND COLONY, MANITOBA

**Test Hole No.** TH1      **Sample No.** S3      **Depth:** 2.3 m  
**Sampled By:** ENG-TECH      **Type of Sample:** Grab      **Source:** Project Site  
**Date Sampled:** Jan 28/14      **Date Received:** Jan 28/14      **Date Tested:** Feb 3/14

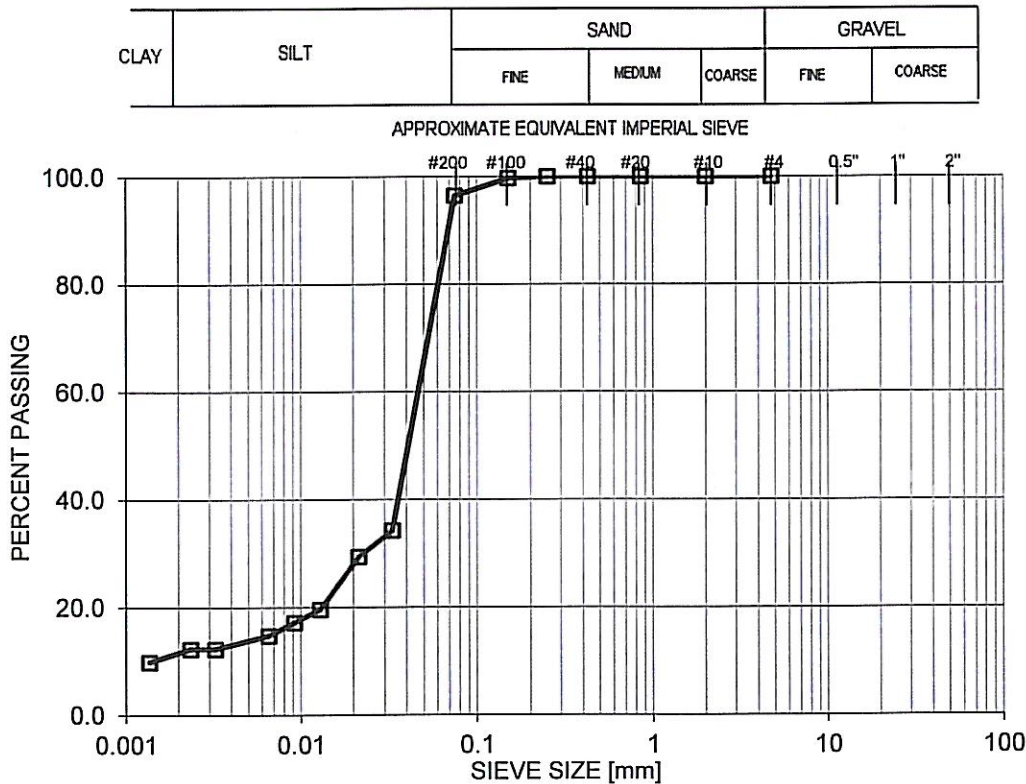

SIEVE SIZE (mm)	PERCENT PASSING
4.750	100.0
2.000	100.0
0.850	100.0
0.425	100.0
0.250	100.0
0.150	99.7
0.075	96.4
0.033	34.3
0.021	29.4
0.013	19.6
0.0092	17.2
0.0066	14.7
0.0032	12.3
0.0023	12.3
0.0014	9.9

**Percent of:** GRAVEL (0.0 %), SAND (3.6 %), SILT (84.8 %), CLAY (11.6 %)  
**Sample Description:**

**COMMENTS:**

**ENG-TECH Consulting Limited**

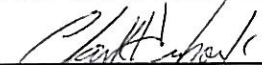
per   
 Clark Hryhoruk, M. Sc., P. Eng, President  
 Ph: (204) 233-1694 Fax: (204) 235-1579





Unit 6 - 854 Marion Street  
 Winnipeg, Manitoba  
 R2J 0K4  
 eng\_tech@mts.net  
 www.eng-tech.ca

**PARTICLE SIZE  
 ANALYSIS REPORT**

Bruns Maendel Constluting Engineers Ltd.  
 1331 Princess Avenue  
 Brandon, Manitoba  
 R7A 0R4

**File No.:** 14-398-01  
**Ref. No.:** 14-398-1-4

**ATTENTION:** Jeff Amundson, E.I.T.

**PROJECT:** SOIL ASSESSMENT, PROPOSED LAGOON, OAKLAND COLONY, MANITOBA

**Test Hole No.** TH2                      **Sample No.** S2                      **Depth:** 1.5 m  
**Sampled By:** ENG-TECH              **Type of Sample:** Grab              **Source:** Project Site  
**Date Sampled:** Jan 28/14              **Date Received:** Jan 28/14              **Date Tested:** Feb 3/14

CLAY	SILT	SAND			GRAVEL	
		FINE	MEDIUM	COARSE	FINE	COARSE

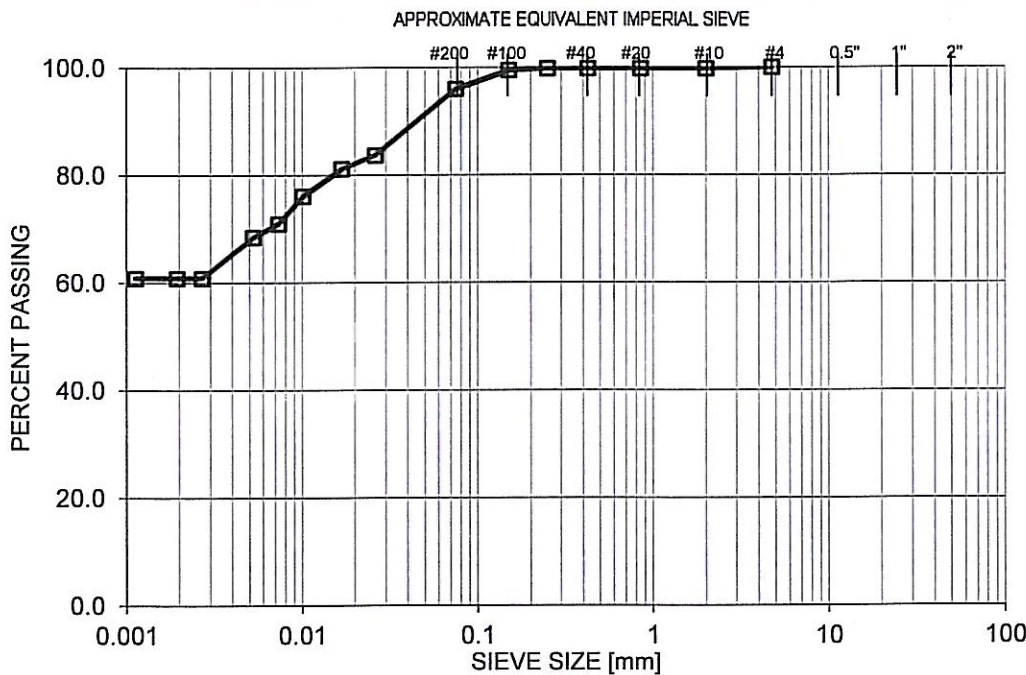

SIEVE SIZE (mm)	PERCENT PASSING
4.750	100.0
2.000	99.8
0.850	99.8
0.425	99.8
0.250	99.8
0.150	99.5
0.075	96.0
0.026	83.7
0.017	81.1
0.010	76.1
0.0073	71.0
0.0053	68.5
0.0027	60.9
0.0019	60.9
0.0011	60.9

**Percent of:** GRAVEL (0.0 %), SAND (4.0 %), SILT (35.1 %), CLAY (60.9 %)  
**Sample Description:**

**COMMENTS:**

**ENG-TECH Consulting Limited**  
 per   
 Clark Hryhoruk, M. Sc., P. Eng, President  
 Ph: (204) 233-1694 Fax: (204) 235-1579



Unit 6 - 854 Marion Street  
 Winnipeg, Manitoba  
 R2J 0K4  
 eng\_tech@mts.net  
 www.eng-tech.ca

**PARTICLE SIZE  
 ANALYSIS REPORT**

Bruns Maendel Constluting Engineers Ltd.  
 1331 Princess Avenue  
 Brandon, Manitoba  
 R7A 0R4

**File No.:** 14-398-01  
**Ref. No.:** 14-398-1-5

**ATTENTION:** Jeff Amundson, E.I.T.

**PROJECT:** SOIL ASSESSMENT, PROPOSED LAGOON, OAKLAND COLONY, MANITOBA

**Test Hole No.** TH2      **Sample No.** S3      **Depth:** 2.3 m  
**Sampled By:** ENG-TECH      **Type of Sample:** Grab      **Source:** Project Site  
**Date Sampled:** Jan 28/14      **Date Received:** Jan 28/14      **Date Tested:** Feb 3/14

CLAY	SILT	SAND			GRAVEL	
		FINE	MEDIUM	COARSE	FINE	COARSE

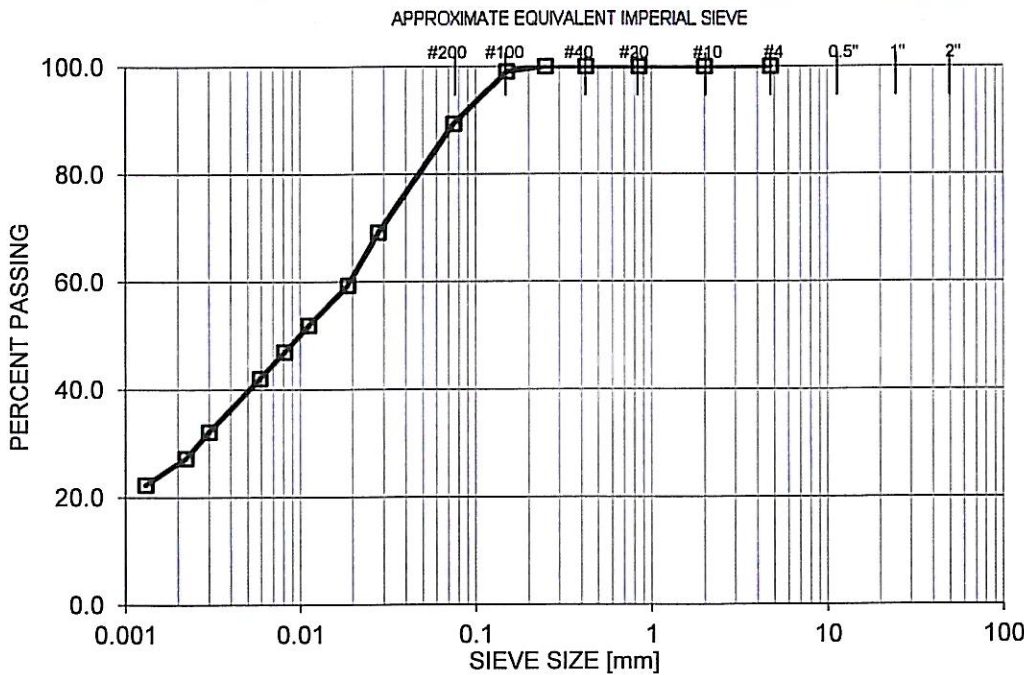

SIEVE SIZE (mm)	PERCENT PASSING
4.750	100.0
2.000	100.0
0.850	100.0
0.425	100.0
0.250	100.0
0.150	99.1
0.075	89.3
0.028	69.2
0.019	59.3
0.011	51.9
0.0081	47.0
0.0059	42.1
0.0030	32.2
0.0022	27.2
0.0013	22.3

**Percent of:** GRAVEL (0.0 %), SAND (10.7 %), SILT (63.0 %), CLAY (26.3 %)  
**Sample Description:**

**COMMENTS:**

**ENG-TECH Consulting Limited**

per *Clark Hryhoruk*  
 Clark Hryhoruk, M. Sc., P. Eng, President  
 Ph: (204) 233-1694 Fax: (204) 235-1579

