

Yazon, Edwin (CC)

From: Yazon, Edwin
Sent: July 28, 2022 11:28 AM
To: Yazon, Edwin (CC) (Edwin.Yazon@gov.mb.ca)
Subject: FW: Steinbach Landfill Phase 2 Expansion
Attachments: MEM - Steinbach Phase 2 Design Memo.pdf

From: Quan, Lauren <Lauren.Quan@tetrattech.com>
Sent: June 21, 2022 5:46 PM
To: Yazon, Edwin (CC) <Edwin.Yazon@gov.mb.ca>
Cc: Wood, William <William.Wood@tetrattech.com>; Eldon Wallman <ewallman@steinbach.ca>; Aaron Rach <aaron.rach@steinbach.ca>; Heckert, Kara <KARA.HECKERT@tetrattech.com>
Subject: Steinbach Landfill Phase 2 Expansion

CAUTION: This email originated from an External Sender. Please do not click links or open attachments unless you recognize the source.

ATTENTION: ce courriel provient d'un expéditeur externe. Ne cliquez sur aucun lien et n'ouvrez pas de pièce jointe, excepté si vous connaissez l'expéditeur.

Hello Edwin,

Following up from our previous conversation I have attached the design technical memo and design drawings for the Steinbach Landfill Phase 2 Expansion submitted on behalf of the City of Steinbach. Eldon Wallman and Aaron Rach from the City of Steinbach are copied. I am happy to discuss any questions or comments at your convenience.

I will give you a call in the next couple of days to see if there is any other information you need to complete your review.

Thank you,
Lauren

Lauren Quan, P.Eng. | Lead, Manitoba Solid Waste Management
Direct +1 (204) 954-6850 | Mobile +1 (204) 688-4928 | Lauren.Quan@tetrattech.com

This message, including any attachments, may include privileged, confidential and/or inside information. Any distribution or use of this communication by anyone other than the intended recipient is strictly prohibited and may be unlawful. If you are not the intended recipient, please notify the sender by replying to this message and then delete it from your system.

To:	Aaron Rach, Eldon Wallman	Date:	June 20, 2022
c:		Memo No.:	02
From:	Lauren Quan, William Wood, Kara Heckert, Paul Evans	File:	704-SWM.ONMB03157-01
Subject:	Phase 2 Landfill Design Memo		

1.0 INTRODUCTION

Tetra Tech Canada Inc. (Tetra Tech) was retained by the City of Steinbach (City) to provide engineering consulting services for the 2022 Landfill Expansion Phase 2 at the Steinbach Class 1 Waste Disposal Ground (Steinbach Landfill). The Steinbach Landfill is operated under *Environmental Act* License (EAL) No. 2918RR serving the City and the surrounding area.

1.1 Project Scope

The scope of the Phase 2 Expansion design project includes:

- Assessment of the adequacy of the existing leachate evaporation pond to manage leachate generated by the expansion area;
- Removal and sorting of stockpiles in the Phase 2 Expansion area;
- Expansion of the landfill disposal area including:
 - Excavation;
 - Subgrade preparation;
 - Construction of two to three leachate sumps; and
 - Construction of landfill perimeter berm and vertical cut-off wall liner.
- Tie-in between Phase 1 and Phase 2 infrastructure.

1.2 Purpose of this Document

The purpose of this technical memo is to summarize the basis of design. The document includes discussion of the design drawings prepared following site investigations, development of design limitations, estimation of leachate generation using the Hydrologic Evaluation of Landfill Performance (HELP) modelling program, and assessment of the leachate pond's capacity to manage the additional leachate expected from the expanded area of landfill. This memo provides the technical information required for submission to the Ministry of Conservation, Climate, and Parks (the Regulator) for approval of the expansion.

2.0 SITE SUMMARY

2.1 Location

The Steinbach Landfill is located at the southern limits of the City along Hanover Road East in the northern ½ of Section 23 – Township 6 – Range 6 EPM.

2.1.1 Climate

Steinbach is in the “humid continental” climate zone. As identified in Table 2-1, mean monthly temperatures range from -16.6°C in January to 19.0°C in July. This averaged data was collected from 1981 to 2010 at the Steinbach weather station (Climate ID: 5022780).¹ The data also indicates mean monthly precipitation ranges from 22.2 mm in January to 100.1 mm in June. Mean monthly relative humidity ranges from 46.7% in May to 75.1% in December as measured from 1981 to 2010 at the Winnipeg, Manitoba weather station (Climate ID: 5023222).²

Table 2-1: Monthly Mean Climate Data 1981 - 2010 (Steinbach, Manitoba Weather Station, Climate ID: 5022780)

Month	Daily Average Temperature (degrees Celsius)	Average Total Precipitation (mm)	Average Relative Humidity – 1500LST (%)
January	-16.6	22.2	72.7
February	-12.6	14.5	71.7
March	-5.4	21.5	68.5
April	4.1	30.9	49.1
May	11.5	69.2	46.7
June	16.4	100.1	54.5
July	19.0	93.2	55.6
August	18.2	73.8	52.4
September	12.3	57.0	54.8
October	5.0	45.9	60.1
November	-4.9	28.1	72.0
December	-13.4	24.2	75.1
Annual	2.8	580.5	61.1

¹ Government of Canada. (2022). Canadian Climate Normals 1981-2010 Station Data, Climate ID: 5022780.

² Government of Canada. (2022). Canadian Climate Normals 1981-2010 Station Data, Climate ID: 5023222.

Figure 2-1 provides a visual of the temperature and precipitation climate normal for Steinbach between 1981 and 2010. The graph indicates that the peak precipitation month is in June (100.1 mm) followed by July (93.2 mm) and August (73.8 mm).

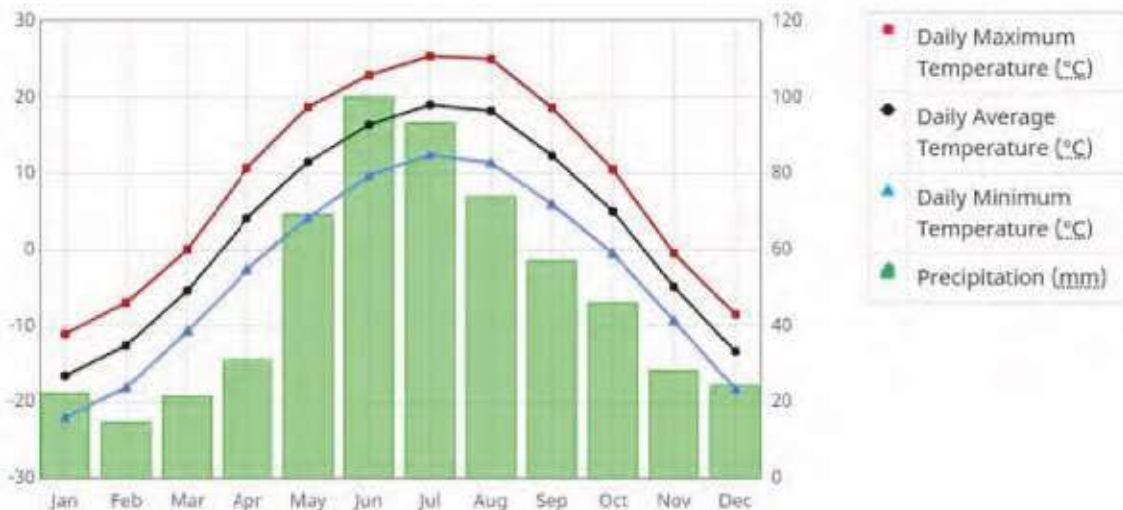

Figure 2-1: Temperature and Precipitation Normals at Steinbach, MB (1981 to 2010)

2.1.2 Regional Geology

Information regarding the regional and site geology was summarized by Gould & Associates in the *Geotechnical Report for the Steinbach Landfill Expansion*, included in Appendix B.³ The Gould report identifies the basic aquifer of Red River valley at approximately 40 metres below ground surface (mbgs) in the limestone bedrock below the site. The limestone bedrock in this region is overlain by glacial till and lacustrine clay deposits. The report also documents fluvial sand and gravel zones below a thick zone of glacial till at a depth of approximately 30 mbgs.

The soils present in the region are comprised of the following stratigraphic units (Matille 2004)⁴:

- Littoral Deposits – sand and gravel of carbonate origin that vary in size, in this case the carbonate is limestone.
- Glacial Till - a silt sediment that contains particles ranging in size from clay to boulders, suspended in a matrix of mud and sand.

2.1.3 Landfill Subsurface Conditions

2.1.3.1 Landfill Expansion Geotechnical Investigation

Gould & Associates provided a summary of the site geology and presented it in a series of soil stratigraphy cross sections. The surficial soils were summarized by Gould based on 11 boreholes drilled by Paddock Drilling Ltd. (Paddock) in October 2007 on the proposed future expansion site.

Gould found that the initial 1.8 m of soil was fine silty clay, overlying dense glacial till to a depth of at least 18.28 mbgs. The till was found to be fine grained, with little stratification or variation. None of the boreholes

³ A. Dean Gould & Associates. (2008). *Geotechnical Report for the Steinbach Landfill Expansion*

⁴ Matille G.L.D. (2004). *Surficial Geology, Steinbach, Manitoba*. <https://www.manitoba.ca/iem/info/libmin/MAP2003-8.pdf> [accessed January 11, 2022]

penetrated to the deeper permeable zones or to the underlying bedrock aquifer. Two boreholes (TH-8 and TH-9) on the southeast side of the proposed site contained minor zones of sand in the first 3.1 m.

Phase 2 Expansion Area

The site investigation by Gould & Associates included test holes across the Phase 1 and Phase 2 landfill expansion areas. Tetra Tech has inferred the test hole locations based on figures presented in the Gould report included in Appendix B. Inferred test hole locations are presented on drawing C101. Based on these figures the relevant test holes are:

- Test Hole TH-4 – Located in the northern portion of the Phase 2 area. TH-4 shows granular fill overlying silty glacial till from (1.4 mbgs to 4.6 mbgs) and sandy, silty glacial till (from 5.6 mbgs to 6.1 mbgs).
- Test Hole TH-5 – Located near the western boundary of the Phase 2 area. TH-5 shows surficial waste overlying topsoil. The logs describe non-plastic sandy silty clay till (from 1.5 mbgs to 3.7 mbgs) overlying sandy glacial till (from 3.7 mbgs to 6.1 mbgs).
- Test Hole TH-6 - Located near the western boundary of the Phase 2 area. TH-6 shows surficial waste overlying topsoil. The logs describe non-plastic silty clay till (from 0.9 mbgs to 1.2 mbgs) overlying non plastic gravelly till (from 1.2 mbgs to 3.7 mbgs), and non-plastic sandy glacial till (from 3.7 mbgs to 6.1 mbgs).
- Test Hole TH-7 - Located near the southern boundary of the Phase 2 area. TH-7 shows surficial topsoil overlying non-plastic silty clay till of varying colour (from 0.2 mbgs to 18.3 mbgs).
- Test Hole TH-8 - Located within the southeastern corner of the Phase 2 area. TH-8 shows surficial topsoil overlying sand (from 0.6 mbgs to 1.8 mbgs), overlying non-plastic sandy glacial till (from 1.8 mbgs to 3.1 mbgs), and non-plastic silty clay till (from 3.1 mbgs to 6.1 mbgs).
- Test Hole TH-9 - Located within the eastern boundary of the Phase 2 area. TH-9 shows surficial topsoil overlying sand (from 0.6 mbgs to 1.8 mbgs), overlying non-plastic sandy - clay glacial till (from 1.8 mbgs to 2.7 mbgs), and non-plastic silty clay till (from 2.7 mbgs to 6.1 mbgs).

The hydraulic conductivity testing was completed for a sample of the silty clay till unit identified below 3.1 mbgs in TH-8 and 2.7 mbgs in TH-9. **Due to the stiffness of the clay till unit, attempts to collect an undisturbed sample were unsuccessful.** A remolded sample compacted to 98% Standard Proctor Maximum Dry Density (SPMDD) was analyzed. The resulting hydraulic conductivity (k) of 1.2×10^{-6} cm/s is an order of magnitude greater than the maximum allowable hydraulic conductivity of compacted clay liners of 1.0×10^{-7} cm/s and two orders greater than the 1.0×10^{-8} cm/s now required for the subgrade of cut and fill clay cells.

Gould (2008) indicated that the in situ hydraulic conductivity is likely lower than the remolded samples. The opposite assertion is conventionally made, that is, that field hydraulic conductivity is at least one order greater than that measured in remolded samples. Although there is no field testing of hydraulic conductivity with which to compare.

2.1.3.2 Supplemental Phase 2 Expansion Area Investigation

In 2022, Tetra Tech conducted an intrusive investigation in the Phase 2 area to confirm subsurface conditions prior to finalizing the design of the Phase 2 Expansion. The locations of the three boreholes drilled are shown on Drawing C101 with corresponding borehole logs included in Appendix C.

Paddock was again retained to complete boreholes within the Phase 2 Expansion area. Tetra Tech supervised the drilling and logged soils from each flight of the solid stem auger on March 29, 2022. Soil logging used the modified universal soils classification system (USCS) including description of soil type, characteristics, and behaviour. The

boreholes were completed with a 51 mm polyvinyl chloride (pvc) standpipe backfilled with type 10/20 silica sand around the screen and bentonite seal to surface. Subsequent to the installation of the standpipes, Landfill staff measured groundwater levels on April 12, 2022 and May 11, 2022. The 2022 boreholes are summarized in Table 2-2.

Table 2-2: Summary of 2022 Boreholes

	22BH01	22BH02	22BH03
Location	Northeast Corner of Phase 2 Expansion	Northwest Corner of Phase 2 Expansion	Southwest Corner of Phase 2 Expansion
Water Level (mbgs) Measured on April 12, 2022	1.93	3.94	2.16
Water Level (mbgs) Measured on May 11, 2022	Dry, no water measured	2.74	2.36
Stratigraphy (mbgs)	0.0 to 1.8 Clay (Fill) – medium plastic, moist 1.8 to 2.4 Sand – some organics, wet 2.4 to 4.7 Clay (Till) – medium plastic, moist to wet 4.7 to 5.0 Sand 5.0 to 7.8 Clay (Till) – medium to high plastic, damp to moist	0 to 1.4 Sandy (Fill) – coarse grained sand, dry 1.4 to 2.1 Silty clay and sand – non-plastic, moist 2.1 to 6.4 Clay (Till) – non-plastic, damp to moist	0 to 0.2 Topsoil – damp 0.2 to 1.8 Sand – coarse grained, damp 1.8 to 3.7 Sand and Gravel – non-plastic, wet 3.7 to 4.9 Clay (Till) – medium plastic, moist
Inferred Depth to Original Ground (mbgs)	1.8	1.4	0

The 2022 investigation confirmed the presence of clay stockpiled above the original ground surface. Tetra Tech noted evidence of organic materials at depths of approximately 1.8 mbgs in borehole 22BH01 and 1.4 mbgs in borehole 22BH02. These organic materials are interpreted be remnants of topsoil at the original ground surface prior to stockpiling. Materials stockpiled on the Phase 2 Expansion area primarily comprise clean fill including clay, sand, and limited granular materials as well as construction concrete rubble at various thicknesses.

Sand or sand and gravel layers were identified within the till in all boreholes completed in 2022. Water-bearing sand layers were identified in the northeast and southwest corners of the Phase 2 Expansion area. The presence of these sand layers supports the need for lateral hydraulic separation between the landfill and surrounding sand or gravel layers in accordance with the design intent of the landfill Phase 1 expansion. The northwest corner showed layers of sand and clay fill at surface with a moist sand layer at the original ground elevation underlain by clay (till). Within the Phase 2 Expansion surficial sand or gravel layers should be removed and segregated as a component of the excavation.

Clay materials identified below the original ground elevation were mostly in the low to medium plastic range with in situ moisture contents below the material’s plastic limits. Where the moisture content is below the plastic limit, clay does not exhibit plastic properties. The low moisture content of the clay materials indicates that the clay materials are likely not saturated in situ and provides support for the inference that materials logged as “non-plastic till” by others were likely clay till.

Tetra Tech collected material samples for laboratory analysis. Samples were submitted to Trek Geotechnical in Winnipeg, MB for analysis. The results of this analyses are provided in Appendix D and summarized in Table 2-3.

Tetra Tech selected one clay sample from material stockpiled on the Phase 2 Expansion area to be submitted for hydraulic conductivity analysis to assess suitability for use in Compacted Clay Liner. The clay sample was prepared based on Tetra Tech's standard specification for Compacted Clay Liner with density of 94.7% standard proctor maximum dry density (SPMDD). Tetra Tech's standard specification is compaction to 95% SPMDD at 0% to 4% above optimum moisture content. The measured hydraulic conductivity of the sample was 5.55×10^{-9} cm/s.

The native clay deposits on site are visible within the borrow area in the southeast corner of the Phase 2 Expansion area. The borrow area depth is three to four metres below original ground surface. The borrow area is lined by natural glacial till clay deposits. Tetra Tech has logged this clay as silty with some sand to sandy, some gravel, and low to medium plastic.

Table 2-3: Laboratory Results from 2022 Boreholes

Test Location	Sample No.	Description	Natural Moisture Content (%)	Standard Proctor		Atterberg Limits			Remolded Hydraulic Conductivity (cm/sec)	Particle Size Distribution			
				Optimum Moisture Content (%)	Maximum Dry Density (kg/m ³)	Liquid Limit	Plastic Limit	Plasticity Index		Clay %	Silt %	Sand %	Gravel %
22BH01	B1	CLAY, some silt, some gravel, trace sand, stiff, brown, frozen	15.3										
	B4	CLAY, silty, sandy, some gravel, wet, soft, medium plastic	11.6										
	B5	CLAY, sand lenses, medium grained sand, moist, brown	5.7							14.2	52.1	32.9	0.8
	B6	CLAY, damp, hard, medium to high plastic, grey	12.7										
	B7	CLAY, some sand, medium plastic	11.1										
	B8	CLAY, damp, low to medium plastic	10.4										
22BH02	B1	CLAY, silty, sandy, some gravel, organics, moist, medium plastic, black				38	23	15					
	B2	CLAY, silty, sandy, moist, very stiff, low plastic, brown, grey, mottled	11.9			23	12	11					
	B3	CLAY, silty, sandy, moist with damp clay pockets, low plastic, brown	9.6										
	B4	CLAY, silty, sandy, moist with damp clay pockets, low plastic, brown	9.6			24	12	12					
	B5	CLAY, some sand, hard, grey	11.5			25	13	12					
	B6	CLAY, some sand, very hard, grey	9.5										
22BH03	B0	SAND, silty, coarse grained sand, damp, light brown	15.1										
	B2	SAND and GRAVEL, trace silt, trace cobbles, well graded, wet, light brown	8.1										
	B4	CLAY, sandy, moist, medium plastic, dark grey								20.1	37.2	34.3	8.4
	B5	CLAY, sandy, moist, medium plastic, dark grey	16.4										
Field Sample	FS-1	Clay, silty, trace sand		16.1	1,814	44	14	30	5.55 x 10 ⁻⁹	34.3	31.8	33.9	0.0

Table 2-4: Compacted Clay Liner Suitability

Compacted Clay Liner Design Standards			Field Sample Suitability	
Criteria	Requirement	Source of Requirement	Test Result	Meets CCL requirement?
Hydraulic Conductivity	1 x 10 ⁻⁷ cm/sec or less	MB Landfill Criteria ⁵	5.55 x 10 ⁻⁹ cm/sec	Yes (at 95% SPMDD)
Atterberg Limits – Liquid Limit, Plastic Limit, and Plasticity Index	<u>Preferred</u> I _p ≥ 15 30 ≤ LL ≤ 50 Clay ≥ 25% <u>Acceptable</u> 10 ≤ I _p ≤ 15 20 ≤ LL ≤ 30 Or I _p ≥ 15 50 ≤ LL ≤ 75 Clay ≥ 15% to 25%	Unpublished Alberta Landfill Guidelines	LL = 44 PL = 14 I _p = 30 Clay = 34%	Yes (Preferred Range)

⁵ Manitoba Department of Sustainable Development. (2016). Standards for Landfills in Manitoba. Retrieved from https://www.gov.mb.ca/sd/envprograms/swm/pdf/standards_for_landfills.pdf

2.1.4 Hydrogeological Conditions

Tetra Tech understands that there are four existing sources of site-specific hydrogeological information to inform assessment of the subsurface conditions:

- An initial subsurface investigation of the site was conducted in 1993 by Dyregrov Consultants and consisted of nine test holes that extended to depths of up to 3.65 metres below ground surface. Tetra Tech has not reviewed the reporting from this investigation, but it was reviewed by Gould and Associates as a component of their investigation.
- The Gould (2008) investigation included ten test holes in the area of the proposed landfill expansion (Phase 1 and Phase 2).
- The Tetra Tech (2022) supplemental geotechnical investigation included three boreholes in the area of the Phase 2 expansion.
- Groundwater samples are collected biannually to assess any potential groundwater impacts from landfill leachate.

In its landfill expansion (Phase 1 and Phase 2) site investigation, Gould identified the presence of three permeable zones beneath the Phase 1 and Phase 2 areas:

- Surficial sands within the upper 2 mbgs;
- Sand and gravel seams at depths between 16.9 mbgs and 33 mbgs; and
- Limestone aquifer at a depth of 41.3 mbgs.

Hydrogeological studies from Dillon Consulting Ltd. (Dillon) indicate that groundwater is present in the deep bedrock aquifer with the piezometric groundwater surface extending into the upper till layer. Groundwater beneath site flows in a northerly direction, with the piezometric levels in the upper till layer (sand and gravel seams) being 1 m to 2 m below ground surface and water levels in the bedrock wells being between 6 m to 7 m below ground surface.⁶ There is, therefore, a downward vertical gradient that can be found between the sand and gravel units with an average gradient of 0.03 to 0.13.⁷ The dense underlying glacial till layer limits the hydraulic flow between the till and the bedrock aquifer. This is supported by the higher salinity found in the till layer compared to bedrock water samples from below.⁴

2.1.4.1 Surficial Conditions

Anecdotal evidence indicates that a perched groundwater table exists in the southwest corner of the Phase 2 Expansion area. City Staff indicate that the Leachate Pond area showed signs of artesian groundwater conditions prior to development necessitating the construction of an underdrain and sump. The City pumped water from the sump for several years after the Leachate Pond was installed but the sump is now pumped less than one time per year.

Undisturbed samples (Shelby tubes) from boreholes TH-8 and TH-9 of the Gould investigation were submitted for permeability testing at depths of 3.0 mbgs, the lower limit of the surficial sand zone. The density was found to be 2006 kg/m³, porosity was 0.2515, moisture content was 8.1% and hydraulic conductivity (k) was 1.2 x 10⁻⁶ cm/sec. The vertical velocity flow of fluid through this soil was calculated to be 0.089 m/year. The borehole logs do not

⁶ Dillon Consulting Ltd. (2012) City of Steinbach 2011 New Groundwater Monitoring Well Installations & Baseline Conditions

⁷ Dillon Consulting Ltd. (2020). 2020 Annual Operations Report – Final – Steinbach Class I Waste Disposal Ground

include any assessment of groundwater conditions. Typically, a site investigation would include assessment of the Atterberg Limits of underlying soil to confirm soil plasticity, but no testing was completed as a component of Gould investigation.

Tetra Tech submitted samples for laboratory analysis as summarized in Table 2-3. Samples from each borehole were submitted for moisture content analysis. Natural moisture content ranged from 5.7% to 16.4%. Moisture profiles are provided on each borehole log. Five samples from borehole 22BH02 were submitted for Atterberg limits analysis. The laboratory analysis classified two of the five samples as medium plastic clay and the remaining three samples as low plastic clay. Low to medium plastic clay is generally preferred in the construction of Compacted Clay Liner.

The low moisture content of glacial till units during the 2022 investigation indicates that these materials are not saturated despite the water levels measured within the upper till layer during annual groundwater monitoring. Based on this finding, Tetra Tech agrees with the Gould assessment that the relatively impervious glacial till isolates the surface regime from deeper groundwater aquifers.

Gould assessed the Geologic Sensitivity of the landfill expansion area (Phase 1 and Phase 2) as low based on the calculated vertical time of travel (TOT) of approximately 189 years for leachate to reach the sand and gravel seams below 16.9 mbgs.

2.1.5 Topography

The topography of the Steinbach region slopes gently toward the northwest. The natural ground surface within the landfill property slopes to the north at an average grade of less than 1%.

2.2 Site Development History

The site has been developed in two stages to date; with the "Old Landfill" cell on the west side of the site. The Old Landfill was constructed and operated as a natural attenuation cut and fill cell. There is no leachate collection and removal from this Old Landfill. Surface water runoff from the cover on the Old Landfill cell is directed into a surface water pond (identified in the EAL as a storm water pond) located in the northwest corner of the site.

In 2008, the City began planning to expand the landfill to the east. The "Phase 1" landfill expansion was completed in 2011 under the requirements of the current EAL No. 2918RR. The Phase 1 area was constructed as a cut and fill cell with a perimeter berm and cut-off wall liner. A leachate evaporation pond was constructed at the south end of the site to both store and evaporate leachate collected from a drain installed within the Phase 1 area. The surface water from the landfill expansion area flows north to two surface water ponds in the northeast and northwest corners of the facility.

As a component of the Phase 1 construction, a clay borrow area was developed in the southeast corner of the Phase 2 Expansion area. The clay recovered from this area of the site was primarily used as engineered fill in development of the landfill's perimeter access road.

2.3 Site Infrastructure

2.3.1.1 Surface Water Management

The Steinbach Landfill is equipped with two stormwater retention ponds in the northeast corner of site near the office (Drawing C101 in Appendix C) and in the northwest corner of the site north of the Old Landfill. Non-contact

surface water generally drains northwards towards the stormwater retention and evaporation pond through graded ditches and surface flow. The northeast pond is equipped with an outlet control structure and sluice gate allowing the pond to be drained north into a ditch along Hanover Road when appropriate. The northwest pond is equipped with an overflow ditch which also drains north to Hanover Road.

2.3.1.2 Leachate Management

Leachate and contact surface water are managed on site through a system of leachate collection piping, and an evaporation pond with a misting system. Leachate in the Phase 1 landfill expansion area drains into three leachate sumps within the landfill cell. Leachate is pumped from each sump through on-surface pipes to the leachate evaporation pond at the south end of the site. Leachate transfer only takes place during non-frozen conditions.

2.3.1.3 Other Infrastructure

The Steinbach Landfill includes infrastructure to support operations including:

- Surface water ponds in the northwest and northeast corners of site;
- A small public drop-off transfer station at the north end of site;
- A weigh scale and scalehouse located at the site entrance;
- A compost pad and clean wood stockpile area; and
- A septage dewatering area north of the leachate pond.

Site access is provided through a series of gravel roads connecting all areas of the active landfill operations.

3.0 REGULATORY ENVIRONMENT

The Steinbach Landfill is operated under an EAL (No. 2918RR) issued by then Manitoba Sustainable Development now known as Manitoba Conservation, Climate, and Parks (Regulator) on April 26, 2010, and most recently revised on November 26, 2010. This EAL predates the Standards for Landfills in Manitoba published by Manitoba Conservation and Climate (then Department of Sustainable Development) in 2016.

3.1 Environment Act License Requirements

The EAL No. 2918RR is the governing document identifying regulatory requirements and conditions of operation of the facility. EAL No. 2918RR requires the City to:

- Submit final engineering design plans to the Director for approval at least 30 days prior to construction.
- Construct and maintain the storm water retention and sedimentation pond(s) and the compost facility with continuous clay liners.
- Collect and test undisturbed soil samples from any constructed clay liner under the supervision of the assigned Environment Officer.
- Receive approval from the Director prior to operating the area tested.
- Strip and stockpile topsoil from the ground surface prior to construction.

- Submit an updated monitoring program at least 30 days prior to depositing waste in any new waste disposal cell.
- Provide the director "as constructed drawings" 30 days after completion of construction.

3.2 Standards for Landfills in Manitoba Guidance

The Standards for Landfills in Manitoba (Standards) provide the minimum requirements for basic siting, design, monitoring, planning, closure and post closure activities for new and existing waste disposal grounds.⁸ The Standards require the City to:

- Submit design plans prior to construction.
- Notify the assigned Environment Officer five days prior to proceeding with any approved construction.
- Design and construct or fence active areas and material storage areas to retain loose garbage and materials.
- Design above-grade waste cells to retain leachate to the depth of potential leachate accumulation.
- Design its leachate collection system with a porous layer of drainage gravel to channel leachate to a collection and extraction point.
- Size the leachate containment system to contain, until evaporation, all leachate collected at the facility with a freeboard of 1 metre above the maximum elevation of leachate.

For the purpose of landfill siting the Standards state that the lowest cut or base of liner elevation should be at least one metre above the seasonal high-water table.

4.0 LEACHATE POND CAPACITY

The following section estimates the existing leachate pond's leachate evaporation capacity. As the landfill footprint expands and site's leachate production increases, the City can use the information given below to determine when the leachate pond capacity must be increased.

4.1 Pond Capacity

Drawings for the leachate evaporation pond show it is lined with a single layer High Density Polyethylene (HDPE) geomembrane and is equipped with an underdrain. According to the construction record drawings, the maximum volume of leachate which can be contained under normal operating conditions is 8,780 m³ at a depth of 1.43 m measured from the top of the sump at the centre of the pond.⁹ Three leachate misters are installed in the pond. The leachate misters are retrofitted leachate evaporation units situated in the central area of the pond that pump leachate from the pond and atomize the liquid through a set of nozzles to encourage bulk evaporation of the leachate water fraction. A summary of the pond capacity is provided in Table 4-1.

⁸ Manitoba Conservation and Climate. 2016. *Standards for Landfills in Manitoba*.

⁹ Dillon Consulting Ltd. (2012). City of Steinbach Class 1 Waste Disposal Ground Construction Project "As Constructed" Drawings. Total pond depth approximately 2.4 m.

Table 4-1: Summary of Leachate Evaporation Pond Capacity

Leachate Elevation (masl) ⁹	Leachate depth (m)	Volume of Leachate (m ³) ⁹
270.32	-	-
270.82	0.5	1,440
271.07	0.8	3,200
271.32	1.0	5,110
271.57	1.3	7,175
271.75	1.4	8,780

Note: Maximum pond depth is 1.4 m to maintain the 1 m freeboard.

Tetra Tech notes that leachate sludge is expected to accumulate within the pond over time as leachate is evaporated. The presence of sludge is expected to progressively reduce the capacity of the leachate evaporation pond and will need to be characterized and removed.

The evaporation potential of the pond was estimated to determine the volume of leachate the pond can effectively process through evaporation. The evaporation potential of the leachate pond was found by accounting for two factors: passive evaporation from the surface of the pond during warmer months and active evaporation from the operation of leachate misting units during warmer months.

The passive leachate evaporation was estimated using the 1981 to 2010 climate normals for Winnipeg and Steinbach. Climate normals are a set of climatic data produced by Environment Canada that represent typical monthly climate data for specific locations. The climate normal daily evaporation rate for each month for small, open waterbodies was combined with a calculated pond area to estimate the expected volume of leachate that will evaporate from the pond under natural conditions.

The calculated evaporation potential for the leachate pond is shown in Table 4-2.

To estimate the leachate evaporation from the misting units, known performance data for commercially available leachate misting units was used. Because the site's misting units were constructed by City staff there was no performance data available. As an estimate, the performance data for an Ecomister HD24 unit was used. The Ecomister HD24's mid-range processing capacity was assumed to be comparable for the site's misters. The misters were assumed to operate for 24 hours per day, six days per week, from mid-April to mid-September.

Table 4-2: Evaporation Potential of Leachate Pond

Month	Monthly Precipitation	Volume of Precipitation Falling onto Pond Area	Lake Evaporation	Evaporation Volume*
	(mm)	(m ³)	(mm)	(m ³)
July	93.2	735.6	145.7	6,510.2
August	73.8	582.5	139.5	6,461.3
September	57.0	449.9	87.0	2,026.7
October	45.9	362.3	43.4	342.5
November	28.1	221.8	None	None
December	24.2	191.0	None	None
January	22.2	175.2	None	None
February	14.5	114.4	None	None
March	21.5	169.7	None	None

Month	Monthly Precipitation (mm)	Volume of Precipitation Falling onto Pond Area (m ³)	Lake Evaporation (mm)	Evaporation Volume* (m ³)
April	30.9	243.9	-	1,340.1**
May	69.2	546.2	145.7	6,510.2
June	100.1	790.0	147.0	6,520.5
Annual Total	580.6	4,582.4	708.3	29,711.6

Notes:

* Based on evaporation pond base area of 7,892 square metres with 3 leachate misters.

** Assumes leachate misters running for half of the month of April with 50% efficiency compared to summer months.

4.2 Leachate Capacity Required

An assessment of the leachate generation potential was completed using the Hydrological Evaluation of Landfill Performance (HELP) model Version 3.07. HELP was developed for the United States Environmental Protection Agency to produce a quasi-two-dimensional hydrologic numerical model (via water balance analysis) of landfills, cover systems, and other solid waste containment facilities. HELP is the industry standard for the hydrologic modelling of cover systems and leachate production.

4.2.1 Landfill Development Scenarios

Leachate generation rates were modelled based upon the following worst case development scenario:

- Phase 1 has been filled with MSW and predominantly covered with intermediate cover.
- The working face at the south end of Phase 1 extends over roughly one third of the Phase 2 area with another third of the Phase 2 area covered by an initial lift of MSW. This scenario assumes the southern third of the Phase II area does not contain MSW, and that non-contact surface water is redirected away from the leachate collection system.

4.2.2 Model Results

The landfill development scenario described above was modelled using parameters detailed in Appendix D over a 20-year timeframe. Using the mean meteorological data indicated above, 20-year simulations were run. HELP generated meteorological data using synthetic storm events. Based upon the meteorological and material parameters, the average annual infiltration for each cover type is summarized in Table 4-3.

Table 4-3: Infiltration Rate Summary

Cover Type	Model	Slope (%)	Infiltration Rate (mm/yr)
Phase 1			
Active Face	HELP	1	220.68
Intermediate Cover (vegetated)	HELP	25	126.40
Intermediate Cover (no vegetation)	HELP	25	165.30
	HELP	2	163.11
Phase 2			
Active Face	HELP	1	220.64

Cover Type	Model	Slope (%)	Infiltration Rate (mm/yr)
	HELP	10	218.10

The results of this modelling exercise are presented in Table 4-4.

Table 4-4: Leachate Generation Rate Summary

Cover Type	Infiltration Rate (mm/ha/yr)	Area (m ²)	Leachate Generation Rate (m ³ /year)
Phase 1			
Bare Waste (top of landfill)	220.68	6,525	1,440
Intermediate Cover (vegetated base slope of Phase 1)	126.40	2,800	354
Intermediate Cover	165.30	34,070	5,632
	163.11	30,670	5,003
	Subtotal	74,065	12,428
Phase 2			
Bare Waste	220.64	21,370	4,715
	218.10	24,560	5,357
	Subtotal	67,300	10,072
	Total	141,365	22,500

As indicated in the table, the scenario described is anticipated to generate 22,500 m³/year of leachate in Phases 1 and 2 with 12,428 m³/year being generated in Phase 1 and 10,072 m³/year being generated in Phase 2. A leachate production rate of 22,500 m³/year will be used as the basis for determining whether the existing leachate pond is adequate for this future stage of development. Table 4-5 compares the previously calculated evaporation potential of the leachate pond with the leachate production rate estimated above.

Table 4-5: Leachate Generation Rate Summary

Month	Average Leachate Generation** (m ³)	Monthly Precipitation ¹ (mm)	Monthly Precipitation on Pond ¹ (m ³)	Lake Evaporation (mm)	Evaporation Volume ² (m ³)	Monthly Storage Volume Required (m ³)
July	1,834	93.2	736	146	6,510	-4,676
August	1,719	73.8	582	140	6,461	-4,743
September	2,180	57.0	450	87	2,027	153
October	2,340	45.9	362	43	343	1,997
November	2,235	28.1	222	-	-	2,235
December	2,129	24.2	191	-	-	2,129
January	2,221	22.2	175	-	-	2,221
February	1,727	14.5	114	-	-	1,727
March	1,656	21.5	170	-	-	1,656
April	1,486	30.9	244	-	1,340	146
May	1,311	69.2	546	145.7	6,510	-5,199
June	1,661	100.1	790	147.0	6,520	-4,860

Month	Average Leachate Generation** (m ³)	Monthly Precipitation ¹ (mm)	Monthly Precipitation on Pond ¹ (m ³)	Lake Evaporation (mm)	Evaporation Volume* (m ³)	Monthly Storage Volume Required (m ³)
Annual Total	22,500	580.6	4,582	708.3	29,712	-7,212
Note:						
* Based on evaporation pond base area of 7,892 square metres with 3 leachate misters.						
** Based on Hydrologic Evaluation of Landfill Performance (HELP) modelled leachate generation rates.						

4.2.3 Interpretation and Recommendations

Table 4-5 shows that the expected model volume of leachate produced annually (22,500 m³) does not exceed the annual evaporation potential of the existing leachate pond equipped with three misting units (29,712 m³).

If the working face size assumptions made in the model are accurate, the current pond with three misting units is expected to be sufficient.

Additionally, the City may choose to update management and operational practices to further decrease leachate generation from Phase 1 and Phase 2:

- Filling operations are staged with small working faces;
- The City implements progressive closure of slopes and areas where no further expansion is expected;
- Non-contact surface water generated in the Phase 2 area is diverted away from the leachate collection system and towards the surface water drainage system on site;
- Leachate is pumped from the landfill as storage capacity in the pond is made available; and
- Additional leachate misters are installed and optimized

The recommended minimum separation for each Ecomister HD24 water cannon is 15 m front to back and 9 m side to side indicating that it may be possible to space up to five of these commercial units in the current leachate pond. The City's misters should be spaced to minimize interference between units.

Due to the potential for future leachate generation to exceed current infrastructure evaporation potential, which is currently comprised of two misting units instead of the three assumed in the analysis above, a Leachate Management Contingency Plan will be developed to guide proactive management of leachate storage capacity. This plan will identify monitoring and trigger levels for the City to further develop leachate evaporation capacity.

5.0 DESIGN CRITERIA

The following Section details the design criteria considered and design intent of the 90% Phase 2 design.

5.1 Perimeter Liner

In accordance with the previous (Phase 1) construction and the City's wishes, a perimeter berm and vertical cut-off liner has been included to contain leachate and waste within the Phase 2 expansion area. The cut-off liner was

installed based on the recommendation in the original Gould and Associates Geotechnical Report for the Steinbach Landfill Expansion to isolate landfill leachate from surficial sands identified on the east side of the expansion area. Instead of constructing a perimeter berm with a vertical trench for a cut-off liner Tetra Tech proposes constructing a minimum 1 m thick compacted clay liner on the berm surface and tied into the prepared subgrade clay on the floor of the Phase 2 area. The berm will be constructed of compacted clay to achieve a maximum hydraulic conductivity of 1×10^{-7} m/s.

Tetra Tech understands that the City's long-term plan is to develop the area between the old, unlined landfill and the Phase 1 and Phase 2 lined sections for future waste disposal. If this infill plan is completed, the western edge of the Phase 1 and Phase 2 areas will be covered by waste. Based on preliminary consultation with the Regulator, the City intends to construct Compacted Clay Liner on all permanent perimeter berms but not on any intermediate berms. Therefore, the eastern and southern perimeters will be lined with the Compacted Clay Liner extending around the southwest corner of the Phase 2 area to isolate potential leachate from gravel or sand layers to the west.

Tetra Tech proposes excluding the area of the active face access roads from perimeter berm and cut-off liner construction as this area will fall within the future Phase 3 expansion area. Eliminating construction in this area will simplify the Phase 2 expansion construction and is not expected to impact the environment as groundwater is understood to flow to the North and leachate will be drained away from this area.

5.2 Floor Design

The design elevation of the Phase 2 Expansion area floor was chosen to maintain the landfill base approximately 1.0 m above the inferred groundwater elevations as determined by the supplemental geotechnical investigation. Based on the hydrogeological conditions discussed in section 2.2.4, the seasonal groundwater elevation is interpreted to be below the inferred piezometric surface shown in the Landfill's Annual Reports. The proposed Phase 2 excavation is shown in the attached sections (Appendix E) to depths of up to 4 mbgs (or 2 metres below original ground surface).

The southwest portion of the Phase 2 Expansion contains perched groundwater in surficial sand and gravel layers as discussed in Section 2.2.4. The elevation of groundwater in this area significantly restricts the depth of excavation permitted for the cell floor. Clay liner will be constructed in the southwest portion of the Phase 2 area where surficial sand and gravel layers are encountered to hydraulically separate landfill waste from the adjacent areas.

The previous borrow area at the southeast corner of the Phase 2 expansion will require filling to maintain a minimum 1.0 m vertical buffer above the existing bottom of excavation. Tetra Tech understands that the City has not observed any groundwater infiltration into the borrow area despite the floor of the borrow being below the expected pre-development groundwater elevation and interpreted groundwater contours provided in recent Annual Reports. This lack of groundwater infiltration indicates no or very low groundwater transmission at the existing depth of borrow area.

As shown on the 90% design drawings in Appendix E, the floor of the Phase 2 area is crested at the approximate latitudinal mid-point of the Expansion area. The section north of the crest is graded northwards at a downward grade of 1.5%. The section south of the crest is graded southwards at a downward grade of 1%. These grades were chosen to roughly follow the inferred groundwater elevation contours and to facilitate the drainage of leachate.

The site's EAL does not specify a maximum leachate head to be achieved within the landfill nor does it specify a maximum leachate elevation within sump areas. In keeping with standard industry practice for leachate collection system design, multiple trenches are included to limit the potential for leachate mounding at the centre of the landfill and decrease the reliance on a single leachate transmission pipe. The Phase 2 area is designed with three trenches

The 300 mm floor liner does not tie up to the cut-off wall of Phase 1.

running north to south with a crest in the southern half of the Phase 2 area. The floor of the Phase 2 area is to be graded toward each trench at a slope of at least 1.0%.

5.2.1 Approach to Existing Borrow Area

Qualitative assessment of the borrow area including descriptions from City Staff indicate very little infiltration into the existing borrow area excavation. Surficial examination of this area indicates that there may be some groundwater infiltration at the bottom of the excavation, but lack of accumulation indicates the infiltration rate sufficiently low to allow water to evaporate at surface. The borrow area will be infilled with a minimum 1 m of compacted clay liner to provide the recommended separation of the cell bottom to the seasonal high groundwater level.

5.3 Leachate Collection and Removal System

Three north/south running leachate collection trenches will be installed in the Phase 2 area. The presence of these leachate trenches, with a spacing of approximately 78 m, limits the potential for significant leachate mounding in the Phase 2 area. The drainage aggregate within the trenches will provide enhanced leachate collection capacity as compared to the Phase 1 area. The northern terminus of the three leachate pipes/trenches will be a large leachate collection pipe running east to west along the border between the Phase 1 and Phase 2 areas. This main leachate pipe is graded at 1%. The southern terminus of the three leachate pipes/trenches will be a second large leachate collection pipe graded at 1% and running east to west along the southern edge of the Phase 2 area. These two leachate collection pipes will transport leachate to the perimeter of the Phase 2 area into sumps located in the northeast or southeast corners of the Phase 2 area.

5.4 Surface Water Ditches

Surface water ditching along the perimeter of Phase 2 is designed to direct surface water from the perimeter access road to the stormwater retention pond in the northeast corner of the site. When the Phase 2 area is closed, this perimeter ditching will also transport non-contact surface water runoff from the Phase 2 closure to the stormwater pond.

6.0 LIMITATIONS OF REPORT

This report and its contents are intended for the sole use of the City of Steinbach (Steinbach) and their agents. Tetra Tech Canada Inc. (Tetra Tech) does not accept any responsibility for the accuracy of any of the data, the analysis, or the recommendations contained or referenced in the report when the report is used or relied upon by any Party other than Steinbach, or for any Project other than the proposed development at the subject site. Any such unauthorized use of this report is at the sole risk of the user. Use of this document is subject to the Limitations on the Use of this Document attached in the Appendix or Contractual Terms and Conditions executed by both parties.

7.0 CLOSURE

We trust this technical memo meets your present requirements. If you have any questions or comments, please contact the undersigned.

Respectfully submitted,
Tetra Tech Canada Inc.



Prepared by:
William Wood, E.I.T.
Project Engineer-In-Training,
Solid Waste Management Practice
Direct Line: 587.986.2700



Prepared by:
Kara Heckert, E.I.T.
Project Engineer-In-Training,
Solid Waste Management Practice
Direct Line: 431.554.1745
Kara.Heckert@tetratech.com



Reviewed by:
Lauren Quan, P.Eng.
Project Engineer - Manitoba Lead
Solid Waste Management Practice
Direct Line: 204.954.6850
Lauren.Quan@tetratech.com

Reviewed by:
Paul Evans, P.Eng., MBA
Project Engineer / Senior Consultant
Solid Waste Management Practice
Direct Line: 403.899.1477
Paul.Evans@tetratech.com



Attachments:

- Photographs
- Appendix A: Tetra Tech's Limitations on the Use of This Document
- Appendix B: Background Geotechnical and Hydrogeology Report
- Appendix C: Tetra Tech Borehole Logs 2022
- Appendix D: Geotechnical Lab Results 2022 Drilling
- Appendix E: 90% Design Drawings

PHOTOGRAPHS



Photo 1: Clay Till Material in Borehole 22BH01



Photo 2: Clay (Fill) Stockpiled Above Original Ground at Borehole 22BH01



Photo 3: Material Recovered in Borehole 22BH03



Photo 4: View North of Phase 2 Expansion Area from Borehole 22BH03

APPENDIX A

LIMITATIONS ON THE USE OF THIS DOCUMENT

LIMITATIONS ON USE OF THIS DOCUMENT

GEOENVIRONMENTAL

1.1 USE OF DOCUMENT AND OWNERSHIP

This document pertains to a specific site, a specific development, and a specific scope of work. The document may include plans, drawings, profiles and other supporting documents that collectively constitute the document (the "Professional Document").

The Professional Document is intended for the sole use of TETRA TECH's Client (the "Client") as specifically identified in the TETRA TECH Services Agreement or other Contractual Agreement entered into with the Client (either of which is termed the "Contract" herein). TETRA TECH does not accept any responsibility for the accuracy of any of the data, analyses, recommendations or other contents of the Professional Document when it is used or relied upon by any party other than the Client, unless authorized in writing by TETRA TECH.

Any unauthorized use of the Professional Document is at the sole risk of the user. TETRA TECH accepts no responsibility whatsoever for any loss or damage where such loss or damage is alleged to be or, is in fact, caused by the unauthorized use of the Professional Document.

Where TETRA TECH has expressly authorized the use of the Professional Document by a third party (an "Authorized Party"), consideration for such authorization is the Authorized Party's acceptance of these Limitations on Use of this Document as well as any limitations on liability contained in the Contract with the Client (all of which is collectively termed the "Limitations on Liability"). The Authorized Party should carefully review both these Limitations on Use of this Document and the Contract prior to making any use of the Professional Document. Any use made of the Professional Document by an Authorized Party constitutes the Authorized Party's express acceptance of, and agreement to, the Limitations on Liability.

The Professional Document and any other form or type of data or documents generated by TETRA TECH during the performance of the work are TETRA TECH's professional work product and shall remain the copyright property of TETRA TECH.

The Professional Document is subject to copyright and shall not be reproduced either wholly or in part without the prior, written permission of TETRA TECH. Additional copies of the Document, if required, may be obtained upon request.

1.2 ALTERNATIVE DOCUMENT FORMAT

Where TETRA TECH submits electronic file and/or hard copy versions of the Professional Document or any drawings or other project-related documents and deliverables (collectively termed TETRA TECH's "Instruments of Professional Service"), only the signed and/or sealed versions shall be considered final. The original signed and/or sealed electronic file and/or hard copy version archived by TETRA TECH shall be deemed to be the original. TETRA TECH will archive a protected digital copy of the original signed and/or sealed version for a period of 10 years.

Both electronic file and/or hard copy versions of TETRA TECH's Instruments of Professional Service shall not, under any circumstances, be altered by any party except TETRA TECH. TETRA TECH's Instruments of Professional Service will be used only and exactly as submitted by TETRA TECH.

Electronic files submitted by TETRA TECH have been prepared and submitted using specific software and hardware systems. TETRA TECH makes no representation about the compatibility of these files with the Client's current or future software and hardware systems.

1.3 STANDARD OF CARE

Services performed by TETRA TECH for the Professional Document have been conducted in accordance with the Contract, in a manner

consistent with the level of skill ordinarily exercised by members of the profession currently practicing under similar conditions in the jurisdiction in which the services are provided. Professional judgment has been applied in developing the conclusions and/or recommendations provided in this Professional Document. No warranty or guarantee, express or implied, is made concerning the test results, comments, recommendations, or any other portion of the Professional Document.

If any error or omission is detected by the Client or an Authorized Party, the error or omission must be immediately brought to the attention of TETRA TECH.

1.4 DISCLOSURE OF INFORMATION BY CLIENT

The Client acknowledges that it has fully cooperated with TETRA TECH with respect to the provision of all available information on the past, present, and proposed conditions on the site, including historical information respecting the use of the site. The Client further acknowledges that in order for TETRA TECH to properly provide the services contracted for in the Contract, TETRA TECH has relied upon the Client with respect to both the full disclosure and accuracy of any such information.

1.5 INFORMATION PROVIDED TO TETRA TECH BY OTHERS

During the performance of the work and the preparation of this Professional Document, TETRA TECH may have relied on information provided by third parties other than the Client.

While TETRA TECH endeavours to verify the accuracy of such information, TETRA TECH accepts no responsibility for the accuracy or the reliability of such information even where inaccurate or unreliable information impacts any recommendations, design or other deliverables and causes the Client or an Authorized Party loss or damage.

1.6 GENERAL LIMITATIONS OF DOCUMENT

This Professional Document is based solely on the conditions presented and the data available to TETRA TECH at the time the data were collected in the field or gathered from available databases.

The Client, and any Authorized Party, acknowledges that the Professional Document is based on limited data and that the conclusions, opinions, and recommendations contained in the Professional Document are the result of the application of professional judgment to such limited data.

The Professional Document is not applicable to any other sites, nor should it be relied upon for types of development other than those to which it refers. Any variation from the site conditions present, or variation in assumed conditions which might form the basis of design or recommendations as outlined in this report, at or on the development proposed as of the date of the Professional Document requires a supplementary exploration, investigation, and assessment.

TETRA TECH is neither qualified to, nor is it making, any recommendations with respect to the purchase, sale, investment or development of the property, the decisions on which are the sole responsibility of the Client.

1.7 NOTIFICATION OF AUTHORITIES

In certain instances, the discovery of hazardous substances or conditions and materials may require that regulatory agencies and other persons be informed and the client agrees that notification to such bodies or persons as required may be done by TETRA TECH in its reasonably exercised discretion.

APPENDIX B

BACKGROUND GEOTECHNICAL AND HYDROGEOLOGY REPORT

**A. Dean Gould &
Associates**

A. Dean Gould
308-3295 Pembina Highway
Winnipeg, MB R3T 1V8

Phone 204 269 2829
e-mail Deago1@mts.net
Fax 204 269 2829

**GEOTECHNICAL REPORT FOR THE STEINBACH LANDFILL
EXPANSION**

PREPARED FOR
MARCH 4, 200

BY A. DEAN GOULD P.ENG.

1.0 Terms of Reference

In accordance with authorization provided in October 2007 and the terms of your September 20, 2007 letter to the City of Steinbach, the writer undertook a subsurface investigation of the site on October 25, 2007. The investigation consisted of 11 test holes located in accordance with the attached plan, which was based upon your drawing 07-7695 upon which test hole locations were established by Dillon and the writer. The purpose of the investigation was to determine subsurface soil stratigraphy and evaluate the site for an expansion of the existing landfill operation.

The site is located south of the City of Steinbach along Hanover Road. Generally the site is level and covered with a relatively dense mature stand of poplar. A small depression exists across the southern portion, which may be a remnant of a municipal drain, which has been rerouted to flow around the landfill. Some construction activity has occurred in the area proposed for landfill expansion.

Geology of Site

The landfill site is located on the eastern edge of the Red River Valley which contains deep lacustrine clay deposits. Underlying the clay are deposits of glacial till and Limestone bedrock. The limestone forms the basic aquifer of the Red River valley and has its recharge area east of Steinbach. At the Steinbach landfill site, the clay thickness is thin or non-existent and the Limestone aquifer is some 41.1 meters below prairie level according to the 1999 well logs at this site (NW23-6-6E). There are fluvial sand and gravel zones indicated below a thick zone of glacial till at approximately the 31.7m depth. Glacial till is a heterogeneous mixture of sand, silt and clay, which has been produced through glacial action. Fluvial zones within the till containing water sorted sands and gravels are normal features developing through glacial recession. The static ground water in the well is indicated as 1.5m below prairie level.

Subsurface Investigation

An initial subsurface investigation of the site was conducted in 1993 by Dyregrov Consultants and consisted of nine (9) test holes that extended to depths of 3.65m. The results of this investigation was reported in a report of March 29, 1993.

The 2007 subsurface investigation conducted by the writer included ten (10) test holes in the area of a proposed landfill expansion and one test hole within the existing landfill limits. Test holes were all 150mm in diameter and varied in depth from 6.1 meters to 18.28 meters. None of which penetrated deeper permeable zones or the aquifer. All holes were produced by a truck mounted drilling machine turning solid stem augers, owned and operated by Paddock Drilling of Brandon MB. Sampling and logging of the test holes was performed by the writer's representative under direction. The logs of all test holes are attached to this report.

The soil profile underlying the landfill expansion area appears to consist of approximately 1.8m of silty clay overlying glacial till to depths in excess of 18.28m (re; TH-7). The glacial till is relatively fine, uniform and increases with strength with depth. Examination of the samples by the writer revealed little stratification or varving. Moisture content of the till also decreases with depth and with greater overburden pressure that are normal consolidation impacts. The upper silty clays are variable and contain zones of sand (TH-2, TH-8 and TH-9). In test hole 2 located within an active landfill operations area the sand extends to a depth of 3.1 meters, but in the majority of the area only to 1.8 meters.

A single test hole (TH-11) was advanced through the existing landfill and the soil profile at this location appeared to consist of 12.8 meters of an organic silty clay fill with large quantities of cobbles, boulders and concrete rubble. The underlying glacial till was found at a depth of 12.8 meters and there was no evidence of groundwater or leachate into the test hole.

Laboratory Testing

Selected samples from the investigation were obtained for moisture content determination and for flexible wall permeability testing. Due to the granular character of the dense till soils encountered, it was found that quality undisturbed samples could not be obtained through Shelby tube samplers and all samples are considered disturbed. Flexible wall permeability tests conducted at the Eng-Tech laboratory facilities in Winnipeg are shown appended and all have been remoulded to a density and moisture content believed to be representative of site conditions.

Disturbed samples of soil were obtained for a second examination by the writer and enabled a determination of the insitu moisture content. The moisture content profile is shown on the appended logs.

Three Shelby tube samples were attempted without success due to the granular and dense character of the glacial till. Disturbed samples were then obtained of the base till from Test Hole 8 and 9 and subjected to a Standard Proctor Density test according to ASTM D698-00. Samples compacted to 98% of Maximum Dry density (considered to be near insitu densities) were then tested for Flexible wall permeability testing according to ASTM D084-03 "Standard Test Method for Measurement of Hydraulic Conductivity of Saturated Porous Materials using a Flexible Wall Permeameter." The testing was performed at Eng-Tech Consulting Laboratory in January 2008 and results are shown appended.

The summary of results of the testing is as follows:

Test Hole/Depth	Density	Porosity(p)	Moisture Content	Hydraulic Conductivity (k)
TH-8 & 9 /3.0m	2006 kg/cu.m	0.2515	8.1 %	1.2×10^{-8} cm/sec

The vertical flow velocity of fluid through the till soil based upon the test data and the relationship $V=Ki/p$ would be 0.089 meters per year. The downward hydraulic gradient (i) imposed by the landfill leachate level currently is not measurable (re: TH-11) but is assumed to be the leachate level above the till surface and for purposes of this calculation equal to the water depth in the surficial sands. Any upward gradient from the aquifer will limit downward vertical flow and significantly reduce the hydraulic gradient and thus flow from the landfill. This then reduces the potential for groundwater contamination

Soil Profile

The soil profile as determined, appears to consist basically of consistent dense silty clay till soil to a depth in excess of 18 meters, which has a hydraulic conductivity slightly greater than 1×10^{-7} cm/sec. It must be emphasized that undisturbed (Shelby Tube) samples could not be obtained through conventional means due to the density of the till. Samples were recompacted in the laboratory to 98% of maximum dry density according to ASTM test D698-00. Standard Method for Laboratory Compaction Characteristics of Soil Using Standard Effort (600 kN-m/m³). This degree of compaction selected may produce lower densities than insitu, consequently void ratios and hydraulic conductivities may be higher than in the insitu soils. The computed flow velocity of hydraulic flow based upon the test value as stated above is 0.089 meters per year (see calculation on attached spreadsheet).

In Test Hole 1 silty clay and a 150mm thickness of organics overlie the till. Test Holes 2, 3, 4, 5 and 6 within the landfill expansion area where there is currently construction activity, indicate surficial granular and landfill zones overlying the basal glacial till to depths of 3.05, 1.82, 1.37, 1.52 and 0.91 meters respectively. In Test holes 8, and 9 a natural fine uniform sand strata exists to a depth of 1.82 m and overlies glacial till.

Evidence of this being natural is given by the existence of a surface organic layer and mature vegetation within the area.

Test Hole 11 was augured to a depth of 12.8 meters through landfill and was terminated in the glacial till strata.

Geological Sensitivity of the Landfill to the Aquifer

The well logs and test wells in the area suggest the presence of three permeable zones. These are (a) the surficial sands within the upper 2 meters (b) sand and gravel seams at depths between 16.9 and 33 meters of up to 10.6 m in thickness and (c) the Limestone aquifer at a depth of 41.3 meters

The surface groundwater regime of the site impacting landfill operations was found to be essentially confined to the sand and gravel deposits within the upper 2-meter depth range. The dense, relatively impervious glacial till isolates the surface regime from the deeper groundwater regimes. Leachate migration through surficial sands could be horizontally contained by the use of a perimeter impermeable (compacted clay/bentonite slurry) core barrier which extends from within the perimeter dike down to the relatively impermeable glacial till strata. The sand and gravel strata below 16.9 meters (ref: test wells) may be the source of small domestic water users, however well data of the area would indicate most commercial operations depend upon the deeper Limestone aquifer source which has much higher and dependable capacity. The sensitivity of the upper sand and gravel aquifer to land fill operations (vertical flow) is dependent upon the hydraulic transmissibility of the glacial till. The time of travel (TOT) criteria guideline established by the Manitoba Department of Environment is defined as Travel Distance/Seepage velocity. For this site, based upon the laboratory tests this value is determined as 189 years for vertical flow through the glacial till to reach the sand and gravel aquifer depth of 16.9 m. Therefore as water moving vertically will reach the aquifer within several decades, the landfill expansion area has a Geologic Sensitivity Rating of low.

Summary

In summary, the area of the landfill expansion was found to have a base of silty glacial till having a hydraulic conductivity of 1.2×10^{-6} cm/sec. The computed Time of Travel through these soils is 189 years representing a low geological sensitivity.

The overlying soils to a depth of approximately 2 meters was found to vary from a silty clay to permeable gravel and horizontal leachate containment would be required to meet Environmental standards. Groundwater flow through the surface sands will be dependent upon precipitation and local runoff. It is the writers view that containment could be readily achieved through either perimeter clay core trenches or liners that extend to the glacial till surface.



A. Dean Gould P.Eng.
Geotechnical Consultant

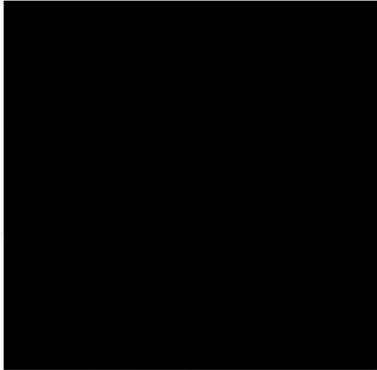

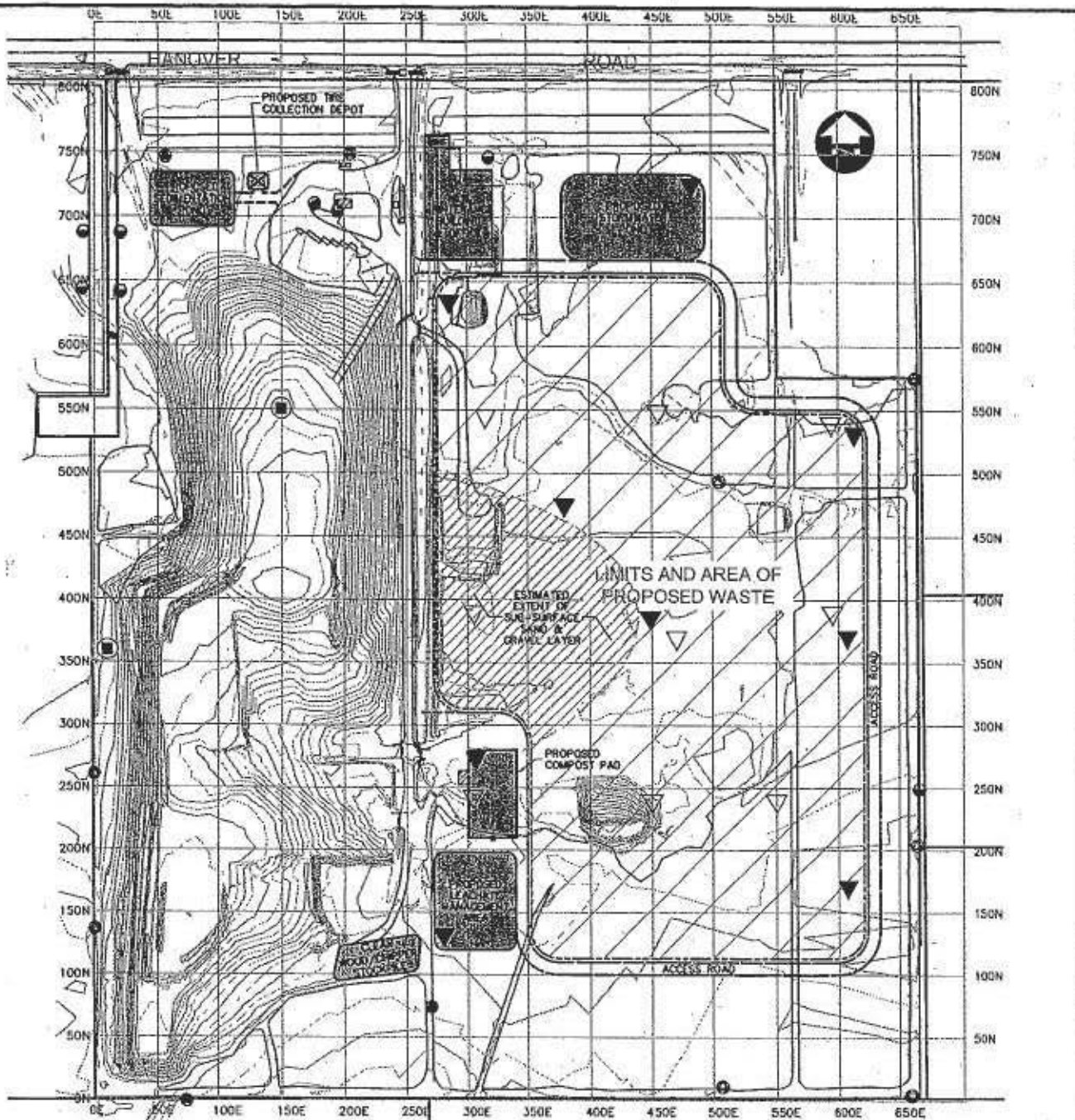

LEGEND:

- MONITORING WELL INSTALLED BY OTHERS IN 1997
- ⊙ MONITORING WELL INSTALLED BY WARDROP IN 2002/2003
- ⊙ MANITOBA CONSERVATION WATER RESOURCES BRANCH-BEDROCK MONITORING WELL
- ⊙ BEDROCK MONITORING WELL INSTALLED BY WARDROP IN 2003
- ⊙ ADDITIONAL MONITORING WELLS/WELLS OBSERVED BY DILLON IN MAY 2007
- ⊙ TEST HOLE LOCATION COMPLETED BY DREGROV CONSULTANTS IN 1993 (APPROXIMATE LOCATIONS)
- ▽ TESTHOLE BY DYREGROV - 1993 (APPROXIMATE LOCATIONS)

PROPOSED WORK:

- ▼ PHASE I TESTHOLES
- ⊙ PHASE II MONITORING WELLS

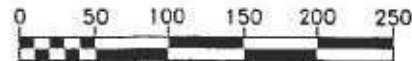

STEINBACH CLASS 1 WASTE DISPOSAL GROUNDS

GEOTECHNICAL/HYDROGEOLOGICAL INVESTIGATION

PROJ. NO.









07-7695







FIG. NO.

1

A. Dean Gould P.Eng and Associates **Location: Steinbach Landfill** **TEST HOLE NO. 1** **PROJECT NO.**
 UTM 14668244E 5485653 N

Project Description: Steinbach Landfill – Hanover Road **Drilling Date: October 25, 2007**
Client : Dillon Consulting Ltd **Driller: PADDOCK DRILLING LTD**
Logged By: J.R. GOULD

SPL No	Depth (m)	Log	SOIL DESCRIPTION Collar Elevation	MOISTURE CONTENT									
				10	20	30	40	50	60	70	80		
			0 - 150mm Organic Sandy Topsoil										
			0.15 – 1.83m Brown Silty Clay										
			1.83 – 6.09 m Grey silty glacial till with clay										
2			End of Hole at 6.02 m No water in hole following drilling operation										
4													
6													
8													
10													

LEGEND
 Topsoil  Silt  Brown clay  Grey clay 
 Glacial till  Sand and gravel 
 Plastic Limit x.....x Liquid Limit
 N=Dutch Cone penetration tests blows/300mm
 Qu= Unconfined Compression Strength (kPa)

TEST HOLE 1

**A. Dean Gould P.Eng
and Associates**

Location: Steinbach Landfill
UTM 14668040E 5485520 N

**TEST HOLE
NO. 2**







PROJECT NO.

Project Description: Steinbach Landfill – Hanover Road
Client : Dillon Consulting Ltd

Drilling Date: October 25, 2007
Driller: PADDOCK DRILLING LTD
Logged By: J.R. GOULD

SPL No	Depth (m)	Log	SOIL DESCRIPTION Collar Elevation	MOISTURE CONTENT										
				10	20	30	40	50	60	70	80			
		▲○●	0 - 1.67m Granular Fill (imported)											
		▲○●	1.67 - 3.05 m Brown fine sand (natural)											
	2	▲○●	3.05 - 3.65 m moist, brown sandy glacial till, fine grained, trace of stone non plastic											
	4	▲○●	3.65 - 4.57m moist brown glacial till with trace of clay											
	6	▲○●	4.57 - 6.09m dark brown, sandy, silt glacial till with trace of clay, non plastic											
			End of Hole at 6.02 m No water in hole following drilling operation											
	8													
	10													

LEGEND

- Topsoil  Silt  Brown clay  Grey clay 
- Glacial till  Sand and gravel 
- Plastic Limit x.....x Liquid Limit
- N=Dutch Cone penetration tests blows/300mm
- Qu= Unconfined Compression Strength (kPa)

TEST HOLE 2

A. Dean Gould P.Eng and Associates	Location: Steinbach Landfill UTM 14668098E 5485340 N	TEST HOLE NO. 3	PROJECT NO.
---	--	----------------------------	--------------------

Project Description: Steinbach Landfill – Hanover Road Client : Dillon Consulting Ltd	Drilling Date: October 25,2007 Driller: PADDOCK DRILLING LTD Logged By: J.R. GOULD
---	---

SPL No	Depth (m)	Log	SOIL DESCRIPTION Collar Elevation	MOISTURE CONTENT									
				10	20	30	40	50	60	70	80		
		0	-1.52m Landfill, with wood chips										
		1.52	1.83 m Brown silty glacial till, moist										
	2	1.83	4.57 m Dark brown silty glacial till with trace of clay, non plastic, stiff, trace of small stone in sample.										
	4												
	6		4.57 – 6.09m grey, sandy glacial till with some clay non plastic										
			End of Hole at 6.02 m No water in hole following drilling operation										
	8												
	10												

LEGEND

Topsoil Silt Brown clay Grey clay

Glacial till Sand and gravel

Plastic Limit x.....x Liquid Limit

N=Dutch Cone penetration tests blows/300mm

Qu= Unconfined Compression Strength (kPa)

TEST HOLE 3





A. Dean Gould P.Eng and Associates	Location: Steinbach Landfill UTM 14668177E 5485226 N	TEST HOLE NO. 4	PROJECT NO.
---	--	----------------------------	--------------------



Project Description: Steinbach Landfill – Hanover Road
Client : Dillon Consulting Ltd

Drilling Date: October 25, 2007
Driller: PADDOCK DRILLING LTD
Logged By: J.R. GOULD

SPL No	Depth (m)	Log	SOIL DESCRIPTION Collar Elevation	MOISTURE CONTENT									
				10	20	30	40	50	60	70	80		
			0 -1.37m Granular Fill (imported)										
	2		1.37 – 4.57 m Brown silty glacial till, a few small pebbles, generally fine grained, stiff, dry										
	4		4.57 – 6.09m grey, sandy, silty glacial till with a trace of clay, fine grained										
	6		End of Hole at 6.02 m No water in hole following drilling operation										
	8												
	10												

LEGEND

Topsoil  Silt  Brown clay  Grey clay 

Glacial till  Sand and gravel 

Plastic Limit x.....x Liquid Limit

N=Dutch Cone penetration tests blows/300mm

Qu= Unconfined Compression Strength (kPa)

TEST HOLE 4

A. Dean Gould P.Eng and Associates **Location: Steinbach Landfill**
 UTM 14668043E 5485139 N **TEST HOLE NO. 5** **PROJECT NO.**

Project Description: Steinbach Landfill – Hanover Road **Drilling Date: October 25, 2007**
Client : Dillon Consulting Ltd **Driller: PADDOCK DRILLING LTD**
Logged By: J.R. GOULD

SPL No	Depth (m)	Log	SOIL DESCRIPTION Collar Elevation	MOISTURE CONTENT									
				10	20	30	40	50	60	70	80		
			0 -1.22m Landfill - garbage										
			1.22 - 1.52 m Black Organic Topsoil										
	2		1.52 - 3.65 m Dark brown, dry sandy, silty Till with some small stone, dense non plastic										
	4		3.65 - 6.09m Grey, sandy glacial till with some clay										
	6		End of Hole at 6.02 m No water in hole following drilling operation										
	8												
	10												

LEGEND
 Topsoil Silt Brown clay Grey clay
 Glacial till Sand and gravel
 Plastic Limit x.....x Liquid Limit
 N=Dutch Cone penetration tests blows/300mm
 Qu= Unconfined Compression Strength (kPa)

TEST HOLE 5

A. Dean Gould P.Eng and Associates	Location: Steinbach Landfill UTM 14668022E 5484998 N	TEST HOLE NO. 6	PROJECT NO.
---	--	----------------------------	--------------------

Project Description: Steinbach Landfill – Hanover Road
Client : Dillon Consulting Ltd

Drilling Date: October 25, 2007
Driller: PADDOCK DRILLING LTD
Logged By: J.R. GOULD

SPL No	Depth (m)	Log	SOIL DESCRIPTION Collar Elevation	MOISTURE CONTENT									
				10	20	30	40	50	60	70	80		
			0 -0.61m Landfill - garbage										
			0.61 - 0.91 m Organic Topsoil										
			0.91 - 1.22 m Grey silty clay Till, non plastic										
	2		1.22 - 3.66 m Brown Gravelly Till, non plastic, silty with some sand and small pebbles										
	4		3.66 - 6.09m Grey, sandy glacial till with some clay, non plastic										
	6		End of Hole at 6.02 m No water in hole following drilling operation										
	8												
	10												

LEGEND

- Topsoil
- Silt
- Brown clay
- Grey clay
- Glacial till
- Sand and gravel
- Plastic Limit x.....x Liquid Limit
- N=Dutch Cone penetration tests blows/300mm
- Qu= Unconfined Compression Strength (kPa)







TEST HOLE 6

A. Dean Gould P.Eng and Associates **Location: Steinbach Landfill**
 UTM 14668239E 5484931 N **TEST HOLE NO. 7** **PROJECT NO.**

Project Description: Steinbach Landfill – Hanover Road **Drilling Date: October 25, 2007**
Client : Dillon Consulting Ltd **Driller: PADDOCK DRILLING LTD**
Logged By: J.R. GOULD

SPL No	Depth (m)	Log	SOIL DESCRIPTION Collar Elevation	MOISTURE CONTENT									
				10	20	30	40	50	60	70	80		
			0 – 0.15m Organic Topsoil, roots										
			0.15 – 3.96 m Brown silty clay Till, stiff, non plastic, contains small stones										
	5		3.96 – 15.24 m Dry Grey silty clay Till, stiff non plastic, contains small stones										
	10												
	15		15.24 – 18.28 m Grey silty clay Till – stiff, non plastic, contains small stones, uniform										
	20		End of Hole at 18.28 m No water in hole following drilling operation Hole backfilled with bentonite										
	25												

LEGEND

Topsoil  Silt  Brown clay  Grey clay 
 Glacial till  Sand and gravel 
 Plastic Limit x.....x Liquid Limit
 N=Dutch Cone penetration tests blows/300mm
 Qu= Unconfined Compression Strength (kPa)

TEST HOLE 7

A. Dean Gould P.Eng and Associates	Location: Steinbach Landfill UTM 14668416E 5484950 N	TEST HOLE NO. 8	PROJECT NO.
---	--	----------------------------	--------------------

Project Description: Steinbach Landfill – Hanover Road Client : Dillon Consulting Ltd	Drilling Date: October 25,2007 Driller: PADDOCK DRILLING LTD Logged By: J.R. GOULD
--	---

SPL No	Depth (m)	Log	SOIL DESCRIPTION Collar Elevation	MOISTURE CONTENT									
				10	20	30	40	50	60	70	80		
DS-1			0 – 0.61 m Organic Topsoil, roots										
			0.61 – 1.82 m Brown fine uniform Sand										
	2		1.82 – 3.05 m Brown coarse sandy Glacial Till, stiff, non plastic										
	4		3.05 – 6.06 m Dry dark brown silty clay Till dense, stiff, uniform, non plastic										
	6		End of Hole at 6.02 m No water in hole following drilling operation Hole backfilled with bentonite										
	8												
	10												

LEGEND

- Topsoil
- Silt
- Brown clay
- Grey clay
- Glacial till
- Sand and gravel
- Plastic Limit x.....x Liquid Limit
- N=Dutch Cone penetration tests blows/300mm
- Qu= Unconfined Compression Strength (kPa)

TEST HOLE 8

A. Dean Gould P.Eng and Associates **Location: Steinbach Landfill**
 UTM 14668411E 5485190 N **TEST HOLE NO. 9** **PROJECT NO.**

Project Description: Steinbach Landfill – Hanover Road **Drilling Date: October 25, 2007**
Client : Dillon Consulting Ltd **Driller: PADDOCK DRILLING LTD**
Logged By: J.R. GOULD

SPL No	Depth (m)	Log	SOIL DESCRIPTION Collar Elevation	MOISTURE CONTENT									
				10	20	30	40	50	60	70	80		
DS-2			0 -0.61 m Organic Topsoil, roots										
			0.61 – 1.82 m Brown fine uniform Sand Till dry to 1.82 m then damp to moist										
	2		1.82 – 2.74 m Brown sandy – clay Glacial Till, stiff, uniform, small stones, non plastic										
	4		2.74 – 6.06 m Dry Grey silty clay Till, stiff, uniform, fine grained, non plastic										
	6		End of Hole at 6.06 m No water in hole following drilling operation										
	8												
	10												

LEGEND

Topsoil Silt Brown clay Grey clay
 Glacial till Sand and gravel
 Plastic Limit x.....x Liquid Limit
 N=Dutch Cone penetration tests blows/300mm
 Qu= Unconfined Compression Strength (kPa)







TEST HOLE 9

A. Dean Gould P.Eng and Associates	Location: Steinbach Landfill UTM 14668370E 5485437 N	TEST HOLE NO. 10	PROJECT NO.
---	--	-----------------------------	--------------------

Project Description: Steinbach Landfill – Hanover Road Client : Dillon Consulting Ltd	Drilling Date: October 25,2007 Driller: PADDOCK DRILLING LTD Logged By: J.R. GOULD
--	---

SPL No	Depth (m)	Log	SOIL DESCRIPTION Collar Elevation	MOISTURE CONTENT													
				10	20	30	40	50	60	70	80						
			0 -0.15m Organic Topsoil, roots														
			0.15 – 3.96 m Grey dry silty clay Till														
	5		3.96 – 10.67 m Dry dark brown, silty Till with a trace of clay, non plastic, fine, very little stone content, stiff														
	10																
	15		10.67 – 18.28 m Dry Grey silty clay Till, stiff, uniform, fine, with a few stones, non plastic														
	20		End of Hole at 18.28 m No water in hole following drilling operation Hole backfilled with bentonite														
	25																

LEGEND

- Topsoil 
- Silt 
- Brown clay 
- Grey clay 
- Glacial till 
- Sand and gravel 
- Plastic Limit x.....x Liquid Limit
- N=Dutch Cone penetration tests blows/300mm
- Qu= Unconfined Compression Strength (kPa)

TEST HOLE 10

A. Dean Gould P.Eng and Associates **Location: Steinbach Landfill**
 UTM 14667892E 5485407 N **TEST HOLE NO. 11** **PROJECT NO.**

Project Description: Steinbach Landfill – Hanover Road **Drilling Date: October 25, 2007**
Client : Dillon Consulting Ltd **Driller: PADDOCK DRILLING LTD**
Logged By: J.R. GOULD

SPL No	Depth (m)	Log	SOIL DESCRIPTION Collar Elevation	MOISTURE CONTENT									
				10	20	30	40	50	60	70	80		
			0 - 12.8 m Landfill Landfill material contains large quantity of organic clay and silt till, large boulders or concrete rubble encountered during drilling.										
	5		12.8 m Original silty till soil, dense, uniform Installed 3.04m of screen then filled remainder of hole with bentonite.										
	10		End of Hole at 12.8 m No water in hole following drilling operation										
	15												
	20												
	25												

LEGEND

Topsoil Silt Brown clay Grey clay
 Glacial till Sand and gravel
 Plastic Limit x.....x Liquid Limit
 N=Dutch Cone penetration tests blows/300mm
 Qu= Unconfined Compression Strength (kPa)

TEST HOLE 11

APPENDIX C

TETRA TECH BOREHOLE LOGS 2022

City of Steinbach

Borehole No: 22BH01

Project: Steinbach Landfill Phase 2

Project No: SWM.ONMB03157-01

Location: Steinbach Landfill

Steinbach, Manitoba

UTM: 668257.02 E; 5485472.32 N; Z 14

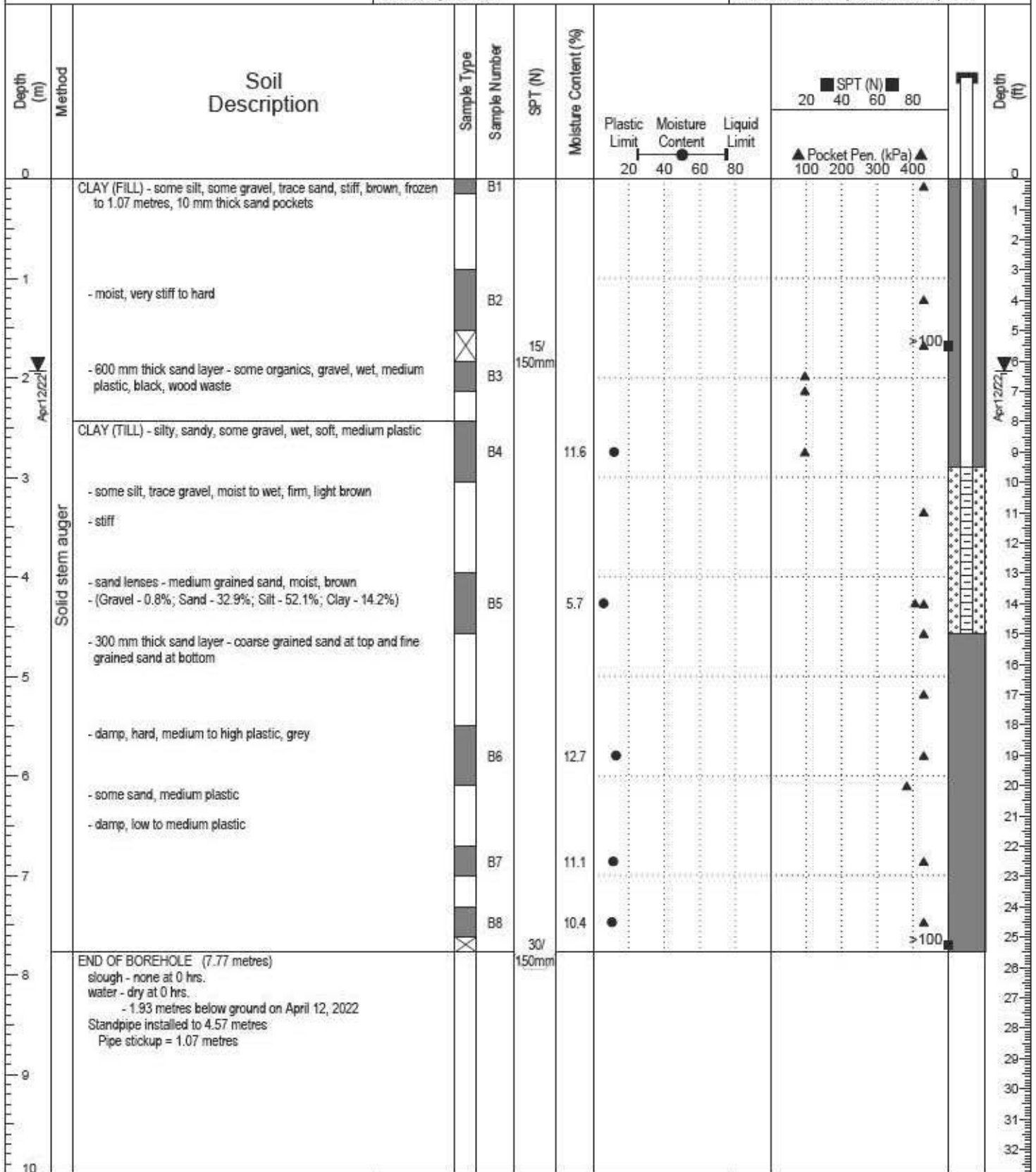

Contractor: Paddock

Completion Depth: 7.77 m

Equipment Type: Track mounted

Start Date: 2022 March 29

Logged By: KHLQ

Completion Date: 2022 March 29

Reviewed By: PE

Page 1 of 1

City of Steinbach

Borehole No: 22BH02

Project: Steinbach Landfill Phase 2

Project No: SWM.ONMB03157-01

Location: Steinbach Landfill

Steinbach, Manitoba

UTM: 668147 E; 5485414 N; Z 14

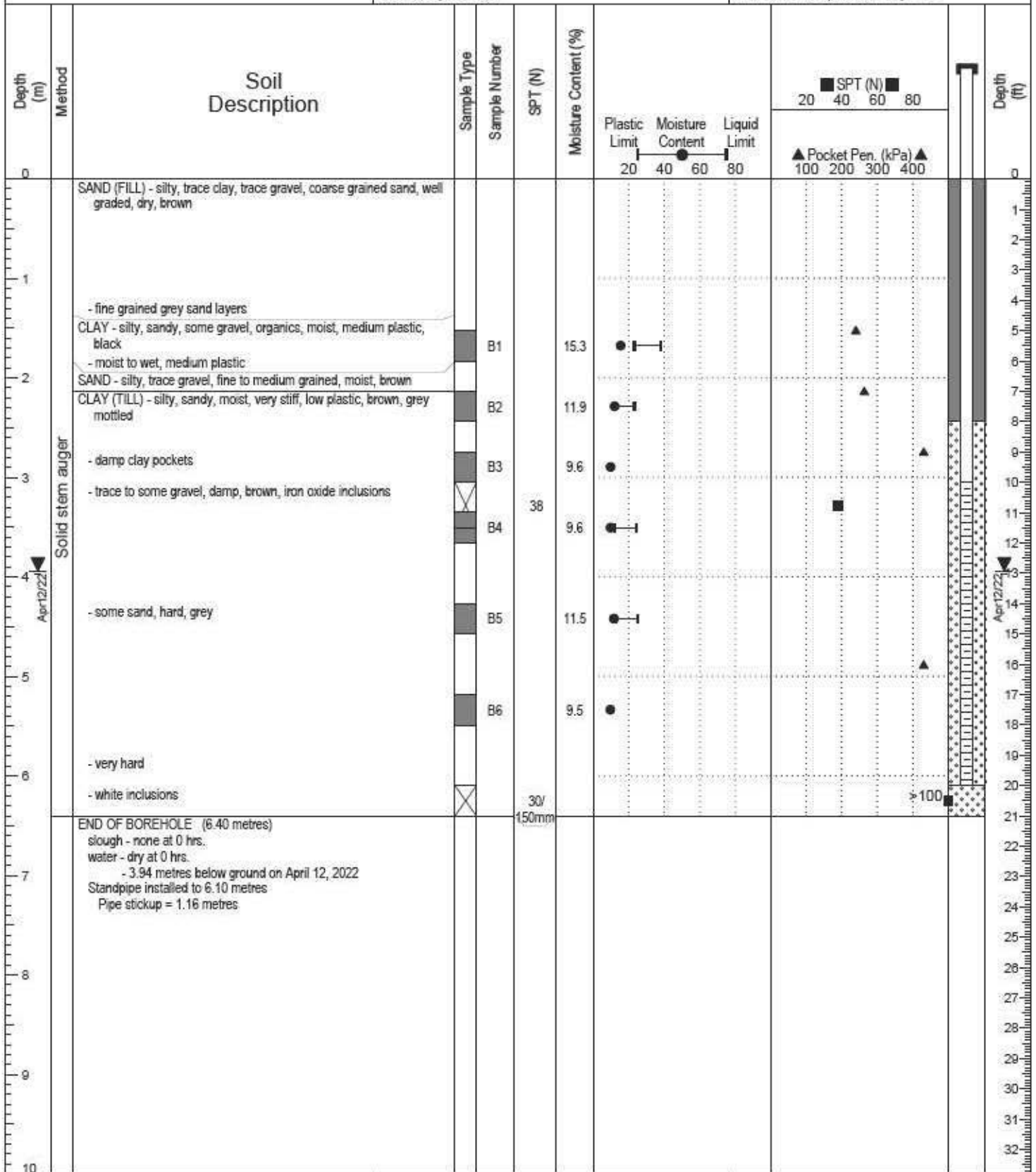

Contractor: Paddock

Completion Depth: 6.4 m

Equipment Type: Track mounted

Start Date: 2022 March 29

Logged By: KHLQ

Completion Date: 2022 March 29

Reviewed By: PE

Page 1 of 1

City of Steinbach

Borehole No: 22BH03

Project: Steinbach Landfill Phase 2

Project No: SWM.ONMB03157-01

Location: Steinbach Landfill

Steinbach, Manitoba

UTM: 668087.62 E; 5485212.52 N; Z 14

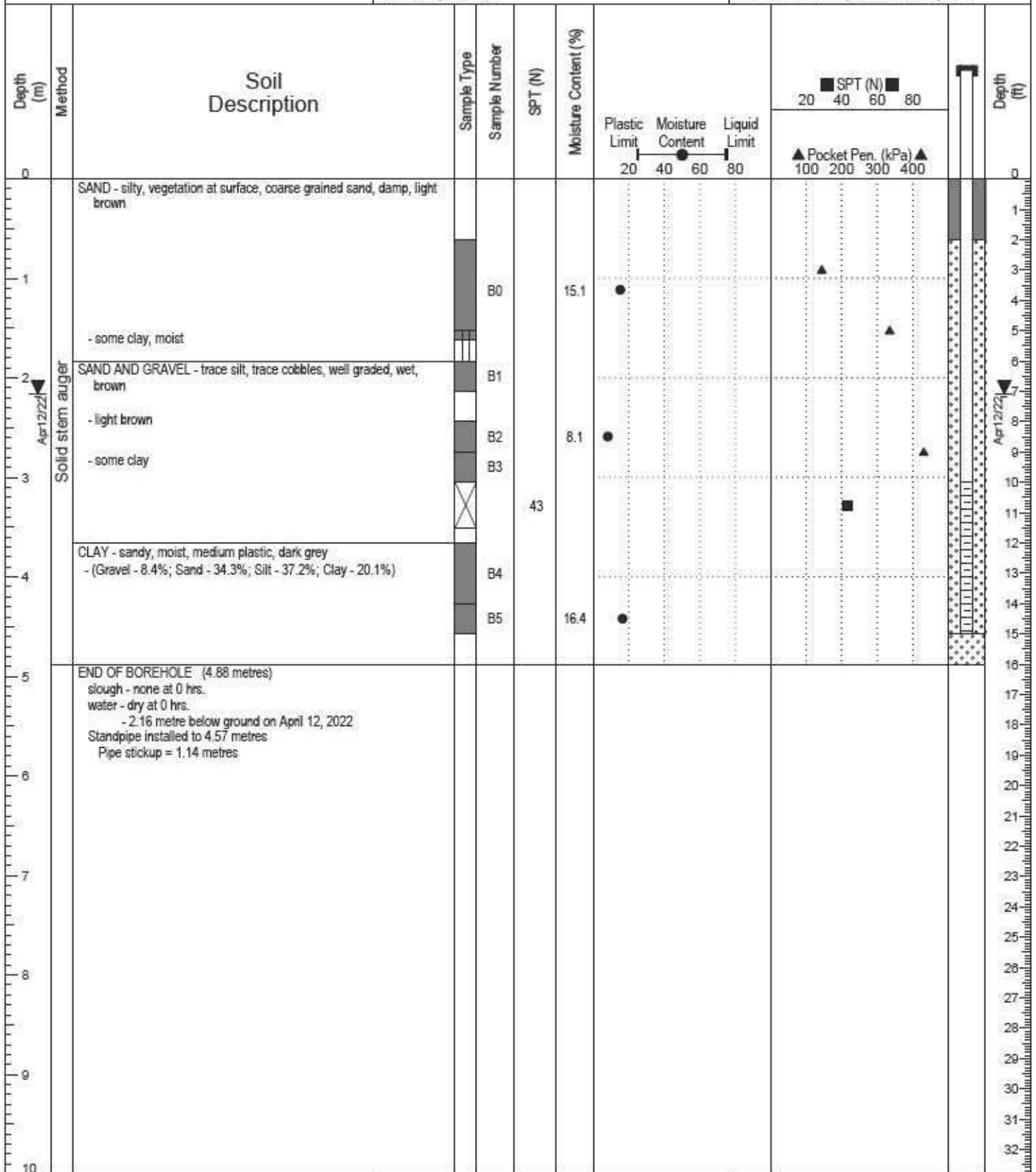

Contractor: Paddock

Completion Depth: 4.88 m

Equipment Type: Track mounted

Start Date: 2022 March 29

Logged By: KHLQ

Completion Date: 2022 March 29

Reviewed By: PE

Page 1 of 1

APPENDIX D

GEOTECHNICAL LAB RESULTS 2022 DRILLING



Quality Engineering | Valued Relationships

April 5, 2022

Our File No. 1000-011-07

Kara Heckert
Tetra Tech Inc.
400 - 161 Portage Ave
Winnipeg, MB
R3B 0Y4

RE Lab Testing Results – 704-SWM, SWOP03157-01 – L22-072

Attached are the laboratory testing results for the above noted project. This report includes moisture content determinations, grain size distribution (Hydrometer method) and Atterberg limits on samples delivered to Trek on March 30, 2022.

A Standard Proctor and a remolded hydraulic conductivity test are ongoing and will be reported upon completion.

If you have any questions or require additional information or clarifications, please contact Angela at 204.792.8458.

Kind Regards,

TREK Geotechnical

Review Control:

<i>Prepared By:</i> DS	<i>Reviewed By:</i> AFK	<i>Checked By:</i> NJF
------------------------	-------------------------	------------------------



Lab Requisition

TREK GEOTECHNICAL
1712 St. James Street
Winnipeg, Manitoba R3H 0L3
T 204.975.9433 F 204.975.9435

PROJECT: 704-SWM_SWAP03157-01 PROJECT NO: 100-011-07
CLIENT: TetraTech FIELD TECHNICIAN: Kara Hackett/Lauren Quan

TEST HOLE NUMBER	SAMPLE NUMBER	Sample Start Depth (ft)	Sample End Depth (ft)	TARE NUMBER (LAB USE ONLY)	MOISTURE	VISUAL CLASS.	ATTERBERG LIMITS	HYDROMETER	GRADATION	STD. PROCTOR	UNCONFINED AND AUXILIARY TESTS	Proctor	Remould.	Soil Description/ Comments
22BH01	B1	0'	1'											
22BH01	B2	1'	2'											
22BH01	B3	2'	3'											
22BH01	B4	3'	4'											
22BH01	B5	4'	5'											
22BH01	B6	5'	6'											
22BH01	B7	6'	7'											
22BH01	B8	7'	8'											
22BH02	B1	5'	6'											
22BH02	B2	6'	7'											
22BH02	B3	7'	8'											
22BH02	B4	8'	9'											
22BH02	B5	9'	10'											
22BH02	B6	10'	11'											
22BH03	B0	2'	5'											
22BH03	B1	5'	6'											
22BH03	B2	6'	7'											
22BH03	B3	7'	8'											
22BH03	B4	8'	9'											
22BH03	B5	9'	10'											
22BH03	B5	10'	11'											
22BH03	ST1	4'	12'											
	FS-1													Shelby tube Please Hold for now Do ATT on Perme



REQUISITION NO.

L22-072

REQUESTED BY: _____ REPORT TO: _____

REQUISITION DATE: _____ DATE REQUIRED: _____

COMMENTS: _____

SHEET _____ OF _____



www.trekgeotechnical.ca
1712 St. James Street
Winnipeg, MB R3H 0L3
Tel: 204.975.9433 Fax: 204.975.9435

Moisture Content Report ASTM D2216-10

Project No. 1000-011-07
Client Tetra Tech
Project 704-SWM, SWOP 03157-01

Sample Date 29-Mar-22
Test Date 30-Mar-22
Technician DS

Test Hole	22BH01	22BH01	22BH01	22BH01	22BH01	22BH02
Depth (m)	2.4 - 3.0	4.0 - 4.6	5.5 - 6.1	6.7 - 7.0	7.3 - 7.6	1.5 - 1.8
Sample #	B4	B5	B6	B7	B8	B1
Tare ID	AC25	AC25	F21	W55	A105	AB33
Mass of tare	6.6	8.6	8.9	8.6	8.6	6.8
Mass wet + tare	303.3	367.5	252.6	261.8	235.5	407.8
Mass dry + tare	272.5	348.1	225.1	236.5	214.1	354.5
Mass water	30.8	19.4	27.5	25.3	21.4	53.3
Mass dry soil	265.9	339.5	216.2	227.9	205.5	347.7
Moisture %	11.6%	5.7%	12.7%	11.1%	10.4%	15.3%

Test Hole	22BH02	22BH02	22BH02	22BH02	22BH02	22BH03
Depth (m)	2.1 - 2.4	2.7 - 3.0	3.4 - 3.7	4.3 - 4.6	5.2 - 6.1	0.6 - 1.5
Sample #	B2	B3	B4	B5	B6	B0
Tare ID	F41	A19	E69	AB01	E94	D17
Mass of tare	8.5	8.6	8.6	6.7	8.4	8.6
Mass wet + tare	466.8	264.9	402.9	416.3	228.2	277.5
Mass dry + tare	418.0	242.5	368.3	374.1	209.2	242.3
Mass water	48.8	22.4	34.6	42.2	19.0	35.2
Mass dry soil	409.5	233.9	359.7	367.4	200.8	233.7
Moisture %	11.9%	9.6%	9.6%	11.5%	9.5%	15.1%

Test Hole	22BH03	22BH03				
Depth (m)	2.4 - 2.7	4.3 - 4.6				
Sample #	B2	B5				
Tare ID	AB10	Z72				
Mass of tare	6.8	8.8				
Mass wet + tare	295.0	297.2				
Mass dry + tare	273.4	256.6				
Mass water	21.6	40.6				
Mass dry soil	266.6	247.8				
Moisture %	8.1%	16.4%				



www.trekgeotechnical.ca
 1712 St. James Street
 Winnipeg, MB R3H 0L3
 Tel: 204.975.9433 Fax: 204.975.9435

Atterberg Limits
ASTM D4318-10e1

Project No.	1000-011-07
Client	Tetra Tech
Project	704-SWM, SWOP03157-01
Test Hole	22BH-02
Sample #	B1
Depth (m)	1.5 - 1.8
Sample Date	29-Mar-22
Test Date	03-Apr-22
Technician	DS



Liquid Limit	38
Plastic Limit	23
Plasticity Index	15

Liquid Limit

Trial #	1	2	3
Number of Blows (N)	15	24	31
Mass Tare (g)	14.059	13.807	14.186
Mass Wet Soil + Tare (g)	23.360	23.144	25.764
Mass Dry Soil + Tare (g)	20.716	20.591	22.653
Mass Water (g)	2.644	2.553	3.111
Mass Dry Soil (g)	6.657	6.784	8.467
Moisture Content (%)	39.718	37.633	36.743

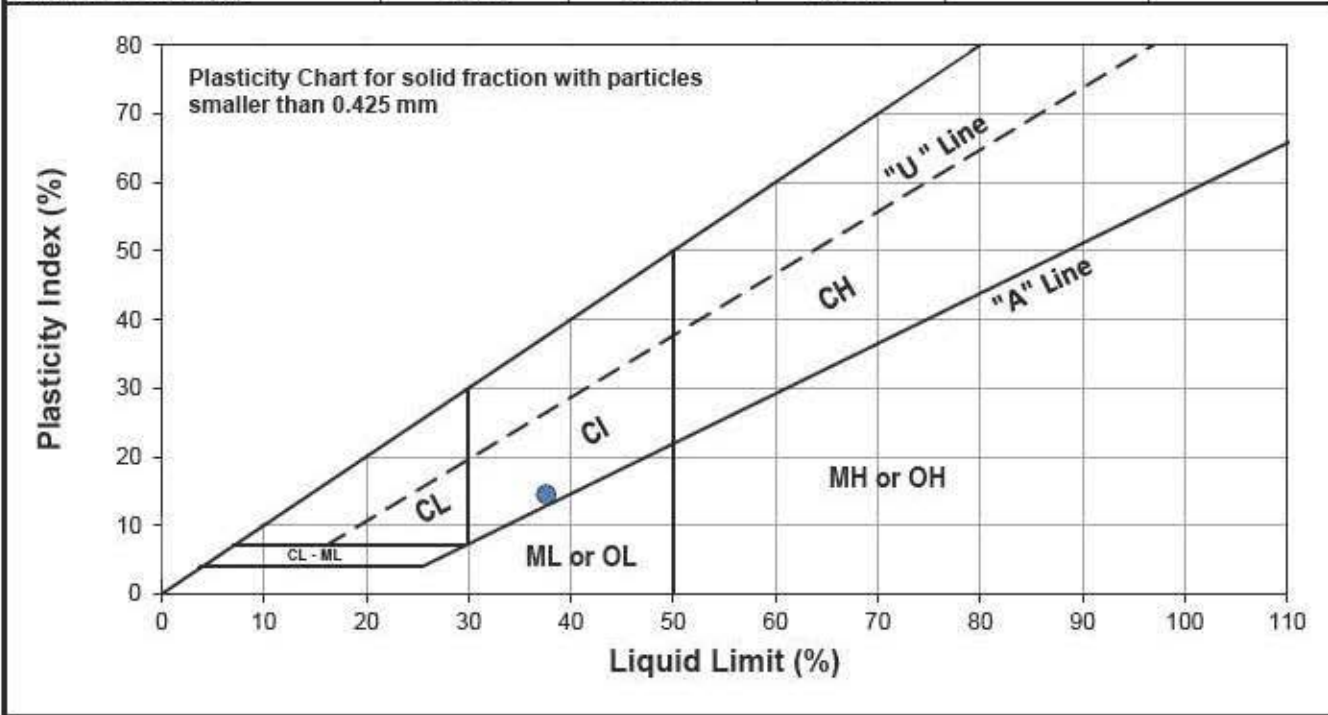

Plastic Limit

Trial #	1	2	3	4	5
Mass Tare (g)	14.169	14.153			
Mass Wet Soil + Tare (g)	23.285	23.007			
Mass Dry Soil + Tare (g)	21.550	21.375			
Mass Water (g)	1.735	1.632			
Mass Dry Soil (g)	7.381	7.222			
Moisture Content (%)	23.506	22.598			

Note: Additional information recorded/measured for this test is available upon request.



www.trekgeotechnical.ca
 1712 St. James Street
 Winnipeg, MB R3H 0L3
 Tel: 204.975.9433 Fax: 204.975.9435

Atterberg Limits
ASTM D4318-10e1

Project No. 1000-011-07
 Client Tetra Tech
 Project 704-SWM, SWOP03157-01

Test Hole 22BH-02
 Sample # B2
 Depth (m) 2.1 - 2.4
 Sample Date 29-Mar-22
 Test Date 03-Apr-22
 Technician DS



Liquid Limit	23
Plastic Limit	12
Plasticity Index	10

Liquid Limit

Trial #	1	2	3
Number of Blows (N)	16	28	34
Mass Tare (g)	14.034	14.264	14.078
Mass Wet Soil + Tare (g)	26.071	25.516	25.002
Mass Dry Soil + Tare (g)	23.736	23.446	23.030
Mass Water (g)	2.335	2.070	1.972
Mass Dry Soil (g)	9.702	9.182	8.952
Moisture Content (%)	24.067	22.544	22.029

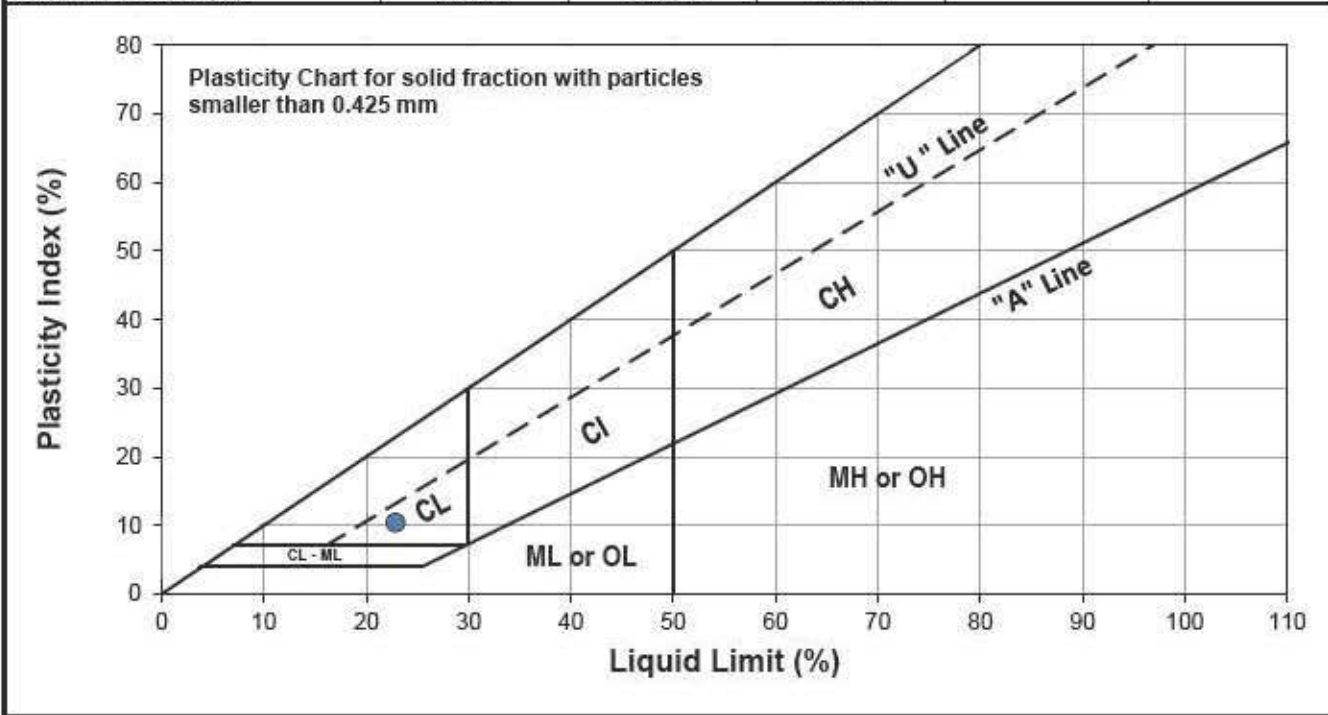

Plastic Limit

Trial #	1	2	3	4	5
Mass Tare (g)	14.089	13.960			
Mass Wet Soil + Tare (g)	23.808	22.737			
Mass Dry Soil + Tare (g)	22.713	21.783			
Mass Water (g)	1.095	0.954			
Mass Dry Soil (g)	8.624	7.823			
Moisture Content (%)	12.697	12.195			

Note: Additional information recorded/measured for this test is available upon request.

Project No. 1000-011-07
 Client Tetra Tech
 Project 704-SWM, SWOP03157-01

Test Hole 22BH-02
 Sample # B4
 Depth (m) 3.4 - 3.7
 Sample Date 29-Mar-22
 Test Date 01-Apr-22
 Technician DS



Liquid Limit	24
Plastic Limit	12
Plasticity Index	12

Liquid Limit

Trial #	1	2	3
Number of Blows (N)	18	28	34
Mass Tare (g)	14.167	13.959	13.898
Mass Wet Soil + Tare (g)	27.557	24.142	26.834
Mass Dry Soil + Tare (g)	24.852	22.182	24.399
Mass Water (g)	2.705	1.960	2.435
Mass Dry Soil (g)	10.685	8.223	10.501
Moisture Content (%)	25.316	23.836	23.188

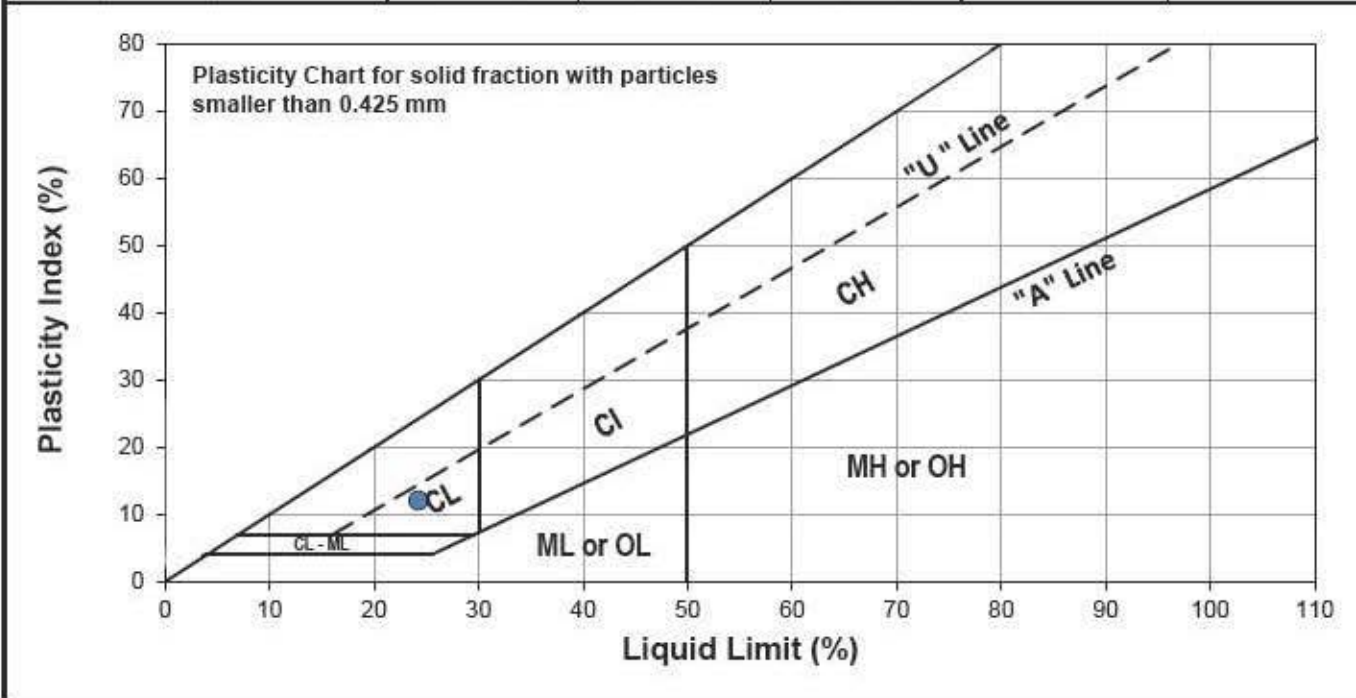

Plastic Limit

Trial #	1	2	3	4	5
Mass Tare (g)	14.056	14.196			
Mass Wet Soil + Tare (g)	22.346	23.732			
Mass Dry Soil + Tare (g)	21.441	22.703			
Mass Water (g)	0.905	1.029			
Mass Dry Soil (g)	7.385	8.507			
Moisture Content (%)	12.255	12.096			

Note: Additional information recorded/measured for this test is available upon request.



www.trekgeotechnical.ca
 1712 St. James Street
 Winnipeg, MB R3H 0L3
 Tel: 204.975.9433 Fax: 204.975.9435

Atterberg Limits
ASTM D4318-10e1

Project No.	1000-011-07
Client	Tetra Tech
Project	704-SWM, SWOP03157-01
Test Hole	22BH-02
Sample #	B5
Depth (m)	4.3 - 4.6
Sample Date	29-Mar-22
Test Date	03-Apr-22
Technician	DS



Liquid Limit	25
Plastic Limit	13
Plasticity Index	11

Liquid Limit

Trial #	1	2	3
Number of Blows (N)	15	29	34
Mass Tare (g)	14.179	13.869	14.089
Mass Wet Soil + Tare (g)	26.378	25.575	25.246
Mass Dry Soil + Tare (g)	23.877	23.301	23.094
Mass Water (g)	2.501	2.274	2.152
Mass Dry Soil (g)	9.698	9.432	9.005
Moisture Content (%)	25.789	24.109	23.898

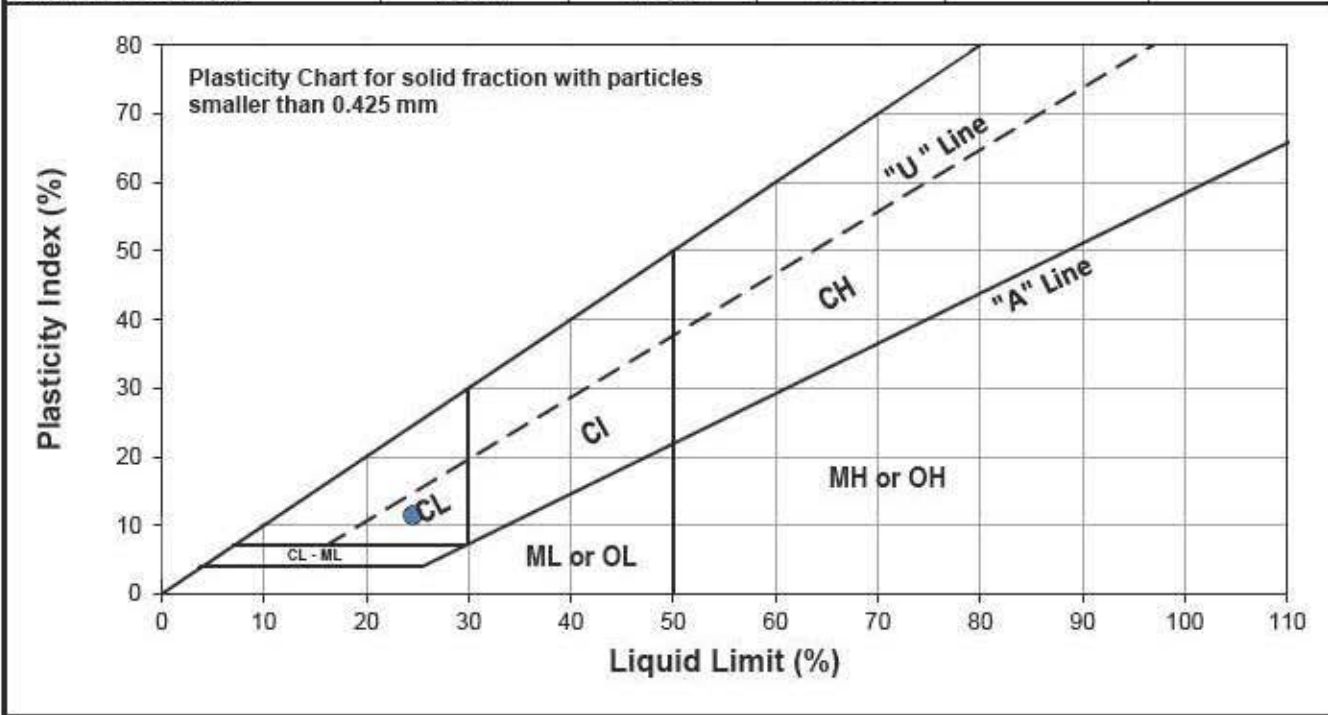

Plastic Limit

Trial #	1	2	3	4	5
Mass Tare (g)	14.078	14.058			
Mass Wet Soil + Tare (g)	23.214	23.071			
Mass Dry Soil + Tare (g)	22.164	22.020			
Mass Water (g)	1.050	1.051			
Mass Dry Soil (g)	8.086	7.962			
Moisture Content (%)	12.985	13.200			

Note: Additional information recorded/measured for this test is available upon request.



www.trekgeotechnical.ca
 1712 St. James Street
 Winnipeg, MB R3H 0L3
 Tel: 204.975.9433 Fax: 204.975.9435

Grain Size Analysis (Hydrometer Method)
AASHTO T 88

Project No. 1000-011-07
Client Tetra Tech
Project 704-SWM, SWOP03157-01



Test Hole 22BH-01
Sample # B5
Depth (m) 4.0 - 4.6
Sample Date 29-Mar-22
Test Date 31-Mar-22
Technician AD

Gravel	0.8%
Sand	32.9%
Silt	52.1%
Clay	14.2%

Particle Size Distribution Curve

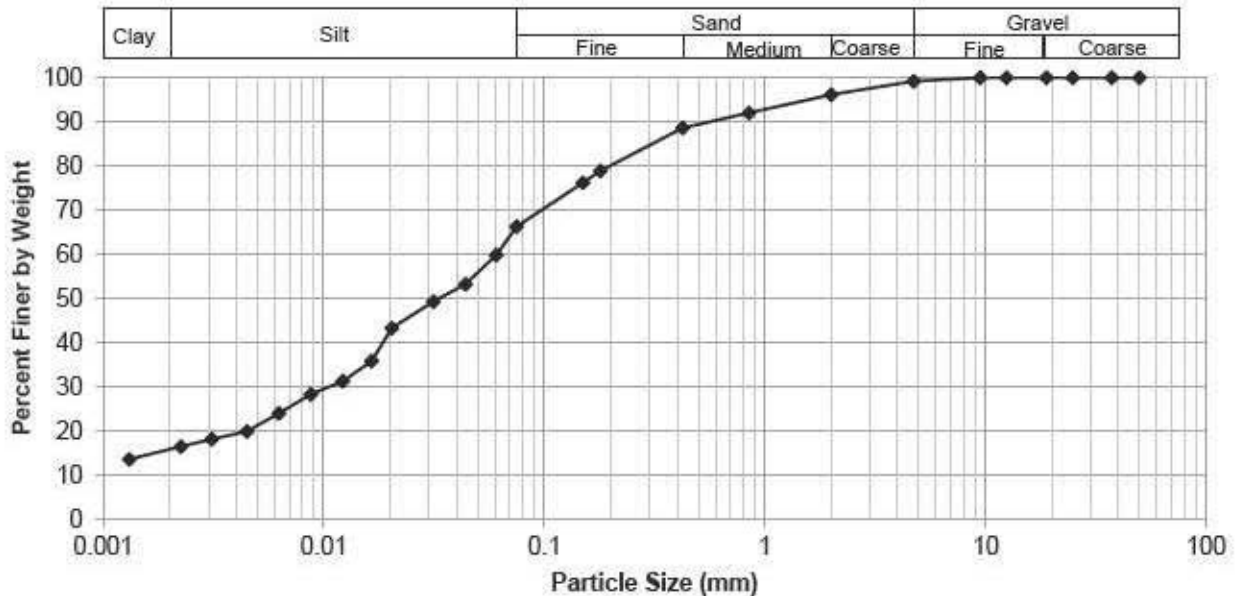

Gravel		Sand		Silt and Clay	
Particle Size (mm)	Percent Passing	Particle Size (mm)	Percent Passing	Particle Size (mm)	Percent Passing
50.0	100.00	4.75	99.23	0.0750	66.30
37.5	100.00	2.00	96.17	0.0605	59.82
25.0	100.00	0.850	92.06	0.0439	53.21
19.0	100.00	0.425	88.62	0.0315	49.30
12.5	100.00	0.180	78.89	0.0204	43.29
9.50	100.00	0.150	76.25	0.0165	35.83
4.75	99.23	0.075	66.30	0.0122	31.26
				0.0087	28.25
				0.0063	23.98
				0.0045	19.90
				0.0031	18.15
				0.0023	16.47
				0.0013	13.58



www.trekgeotechnical.ca
 1712 St. James Street
 Winnipeg, MB R3H 0L3
 Tel: 204.975.9433 Fax: 204.975.9435

Grain Size Analysis (Hydrometer Method)
AASHTO T 88

Project No. 1000-011-07
Client Tetra Tech
Project 704-SWM, SWOP03157-01



Test Hole 22BH-03
Sample # B4
Depth (m) 3.7 - 4.3
Sample Date 29-Mar-22
Test Date 31-Mar-22
Technician AD

Gravel	8.4%
Sand	34.3%
Silt	37.2%
Clay	20.1%

Particle Size Distribution Curve

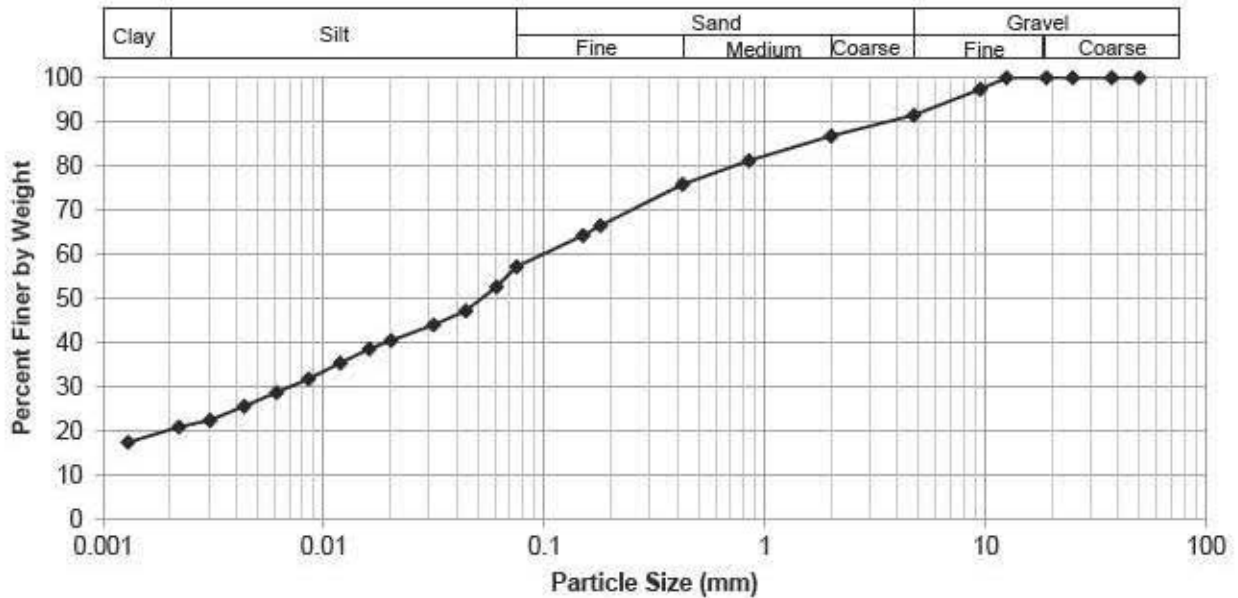

Gravel		Sand		Silt and Clay	
Particle Size (mm)	Percent Passing	Particle Size (mm)	Percent Passing	Particle Size (mm)	Percent Passing
50.0	100.00	4.75	91.56	0.0750	57.24
37.5	100.00	2.00	86.81	0.0609	52.67
25.0	100.00	0.850	81.26	0.0440	47.24
19.0	100.00	0.425	75.87	0.0316	43.98
12.5	100.00	0.180	66.48	0.0202	40.46
9.50	97.38	0.150	64.29	0.0161	38.56
4.75	91.56	0.075	57.24	0.0119	35.36
				0.0085	31.77
				0.0061	28.72
				0.0044	25.59
				0.0031	22.40
				0.0022	20.90
				0.0013	17.38



May 4, 2022

Our File No. 1000-011-07

Kara Heckert
Tetra Tech Inc.
400 - 161 Portage Ave
Winnipeg, MB
R3B 0Y4

RE Lab Testing Results – 704-SWM, SWOP03157-01 – L22-103

Attached are the laboratory testing results for the above noted project. This report includes Atterberg Limits, grain size analysis (Hydrometer method), Standard proctor and hydraulic conductivity test results on a bulk sample (remolded to 94.7% of SPMDD) from FS-1 using a flexible wall permeameter following ASTM D5084-16.

The test report for the sample are attached showing the calculated hydraulic conductivity values corrected to 20°C are as follows:

Sample L22-103 5.55E-11 m/s (5.55 x 10⁻⁹ cm/s)

The services undertaken by TREK on this assignment constitutes testing services only and engineering evaluation or interpretation has not been undertaken, but is available upon request

If you have any questions or require additional information or clarifications, please contact Angela at 204.792.8458.

Kind Regards,

TREK Geotechnical

Review Control:

<i>Prepared By:</i> DS	<i>Reviewed By:</i> AFK	<i>Checked By:</i> NJF
------------------------	-------------------------	------------------------



www.trekgeotechnical.ca
 1712 St. James Street
 Winnipeg, MB R3H 0L3
 Tel: 204.975.9433 Fax: 204.975.9435

Standard Proctor Compaction Test
ASTM D698-12 (2021)



Project No. 1000-011-07
 Client Tetra Tech
 Project 704-SWM, SWOP03157-01

Sample #	L22-072		
Source	FS-1	Corrected Max. Dry Density (kg/m ³)	1861
Material	Clay	Corrected Optimum Moisture (%)	14.9
Sample Date	-	Oversize Material (%)	8
Test Date	02-Apr-22	Maximum Dry Density (kg/m ³)	1814
Technician	DS	Optimum Moisture (%)	16.1

Trial Number	1	2	3	4
Wet Density (kg/m ³)	2041	2120	2108	2063
Dry Density (kg/m ³)	1789	1821	1787	1714
Moisture Content (%)	14.0	16.4	18.0	20.4

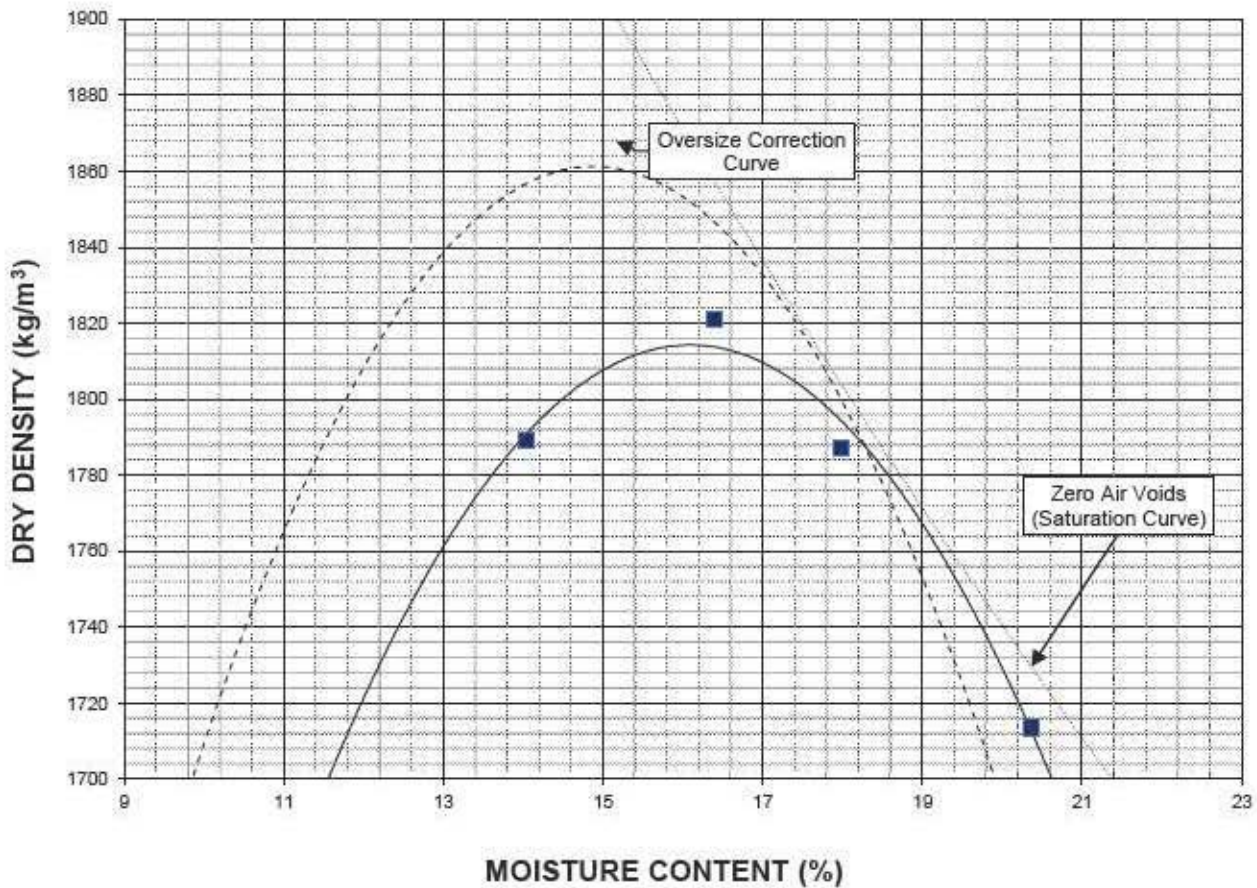

Note: Additional information recorded/measured for this test is available upon request.

Project No. 1000-011-07
 Client Tetra Tech
 Project 704, SWMP0315701

Test Hole FS-1 (bulk)
 Trek Sample # L22-103
 Depth (m) N/A
 Sample Date 30-Mar-22
 Test Date April 7, 2022 to April 30, 2022
 Technician Angela Fidler-Kliewer

Specimen Details

Visual Classification Clay, silty, trace sand, trace to some gravel, high plasticity.

Comments The specific gravity of the soil was assumed to be 2.75. Specimen remolded to 94.7% of SPMDD.

Index Testing

Liquid Limit	44
Plastic Limit	13
Plasticity Index	41
Clay Content (%)	34

Test Details

Permeant	Distilled, de-aired water
Method	Constant Rate
Cell Pressure	130.4 kPa
Influent Pressure	114.9 kPa
Effluent Pressure	85.5 kPa
Gradient	34.06

Permeation Graph

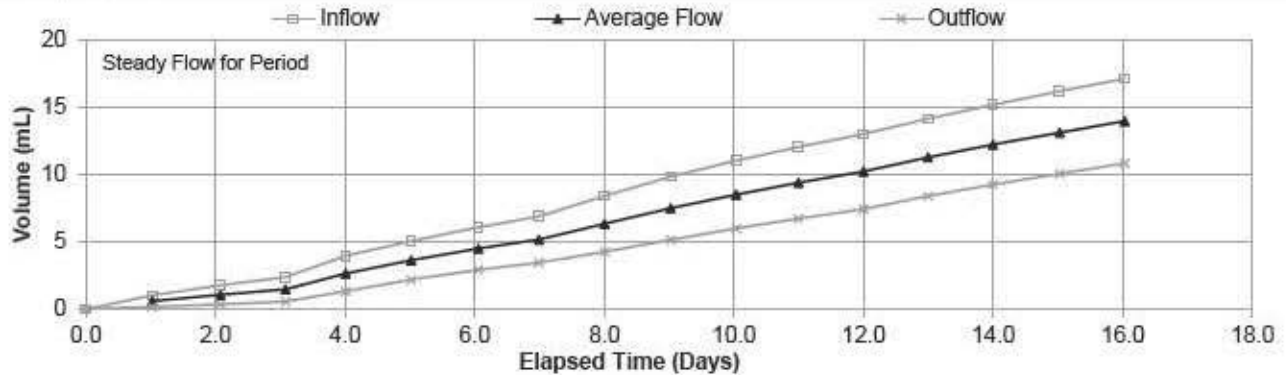

Steady Flow Permeation Data

Time Increment (Days)	Elapsed Time (Days)	Flow (Q)		Inflow / Outflow Ratio	Average Flow (mL)	Temperature Correction	Corrected Hydraulic Conductivity, k_{20} (m/s)
		Influent (mL)	Effluent (mL)				
1.00	13.00	14.16	8.42	1.16	1.06	0.96	6.33E-11
1.00	14.00	15.20	9.26	1.24	0.94	0.96	5.50E-11
1.03	15.03	16.20	10.08	1.22	0.91	0.96	5.32E-11
1.00	16.03	17.14	10.84	1.24	0.85	0.96	5.06E-11

Average Temperature Corrected Hydraulic Conductivity, k_{20} (m/s) 5.55E-11 (5.55×10^{-9} cm/s)

Consolidation Data

	Average Height (m)	Average Diameter (m)	Moisture Content (%)	Dry Density (kN/m^3)	Degree of Saturation (%)	Cell Pressure	Back Pressure
Initial	0.1004	0.0735	18.9	16.8	86.4	120.0	85.4
Final	0.1004	0.0736	21.7	16.8	98.3	121.2	85.5

Project No. 1000-011-07
 Client Tetra Tech
 Project 704-SWM, SWOP03157-01

Test Hole FS-1 (bulk)
 Sample # L22-103
 Depth (m) unknown
 Sample Date 29-Mar-22
 Test Date 02-May-22
 Technician DS



Liquid Limit	44
Plastic Limit	14
Plasticity Index	31

Liquid Limit

Trial #	1	2	3
Number of Blows (N)	18	22	34
Mass Tare (g)	13.877	14.102	13.897
Mass Wet Soil + Tare (g)	24.967	23.964	25.461
Mass Dry Soil + Tare (g)	21.474	20.903	22.024
Mass Water (g)	3.493	3.061	3.437
Mass Dry Soil (g)	7.597	6.801	8.127
Moisture Content (%)	45.979	45.008	42.291

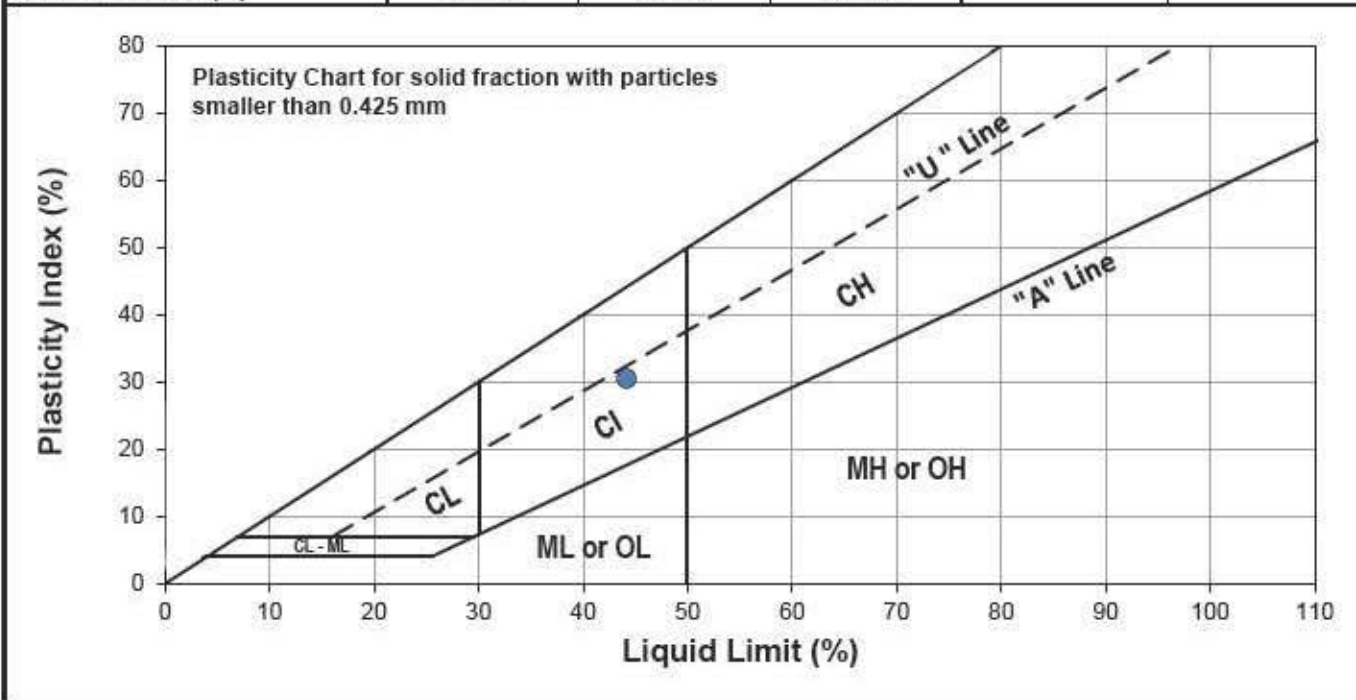

Plastic Limit

Trial #	1	2	3	4	5
Mass Tare (g)	14.091	14.051			
Mass Wet Soil + Tare (g)	21.889	23.477			
Mass Dry Soil + Tare (g)	20.951	22.351			
Mass Water (g)	0.938	1.126			
Mass Dry Soil (g)	6.860	8.300			
Moisture Content (%)	13.673	13.566			

Note: Additional information recorded/measured for this test is available upon request.



www.trekgeotechnical.ca
 1712 St. James Street
 Winnipeg, MB R3H 0L3
 Tel: 204.975.9433 Fax: 204.975.9435

Grain Size Analysis (Hydrometer Method)
AASHTO T 88

Project No. 1000-011-07
 Client Tetra Tech
 Project 704-SWM, SWOP03157-01



Test Hole FS-1 (bulk)
 Sample # L22-103
 Depth (m) unknown
 Sample Date 29-Mar-22
 Test Date 4-May-22
 Technician AFK

Gravel	0.0%
Sand	33.9%
Silt	31.8%
Clay	34.3%

Particle Size Distribution Curve

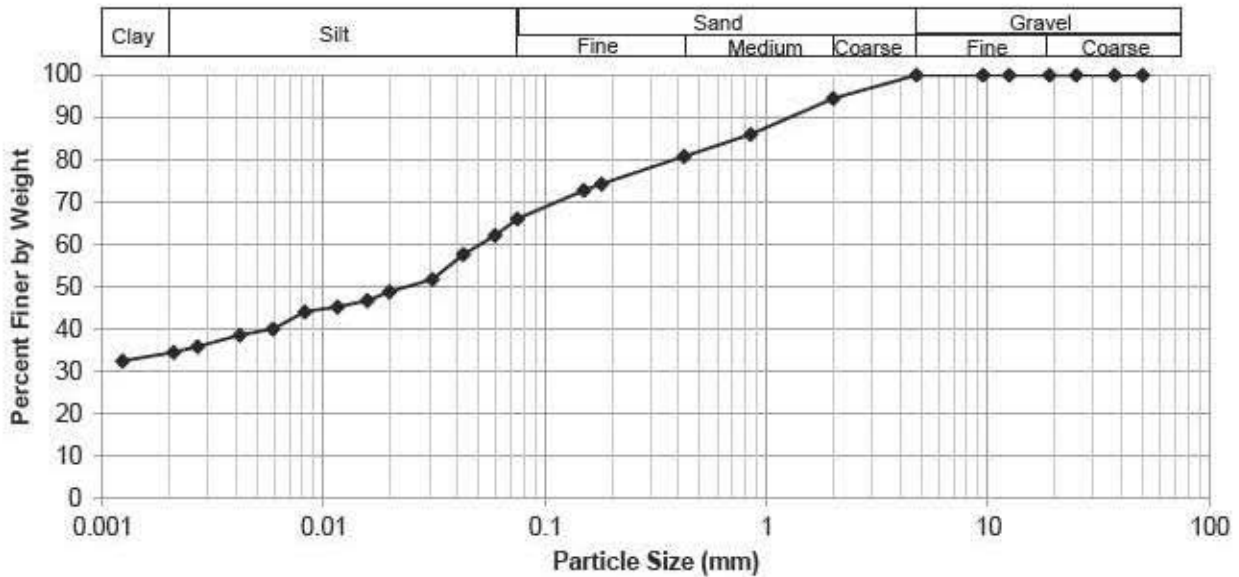

Gravel		Sand		Silt and Clay	
Particle Size (mm)	Percent Passing	Particle Size (mm)	Percent Passing	Particle Size (mm)	Percent Passing
50.0	100.00	4.75	100.00	0.0750	66.12
37.5	100.00	2.00	94.49	0.0594	62.15
25.0	100.00	0.850	86.01	0.0428	57.72
19.0	100.00	0.425	80.82	0.0310	51.81
12.5	100.00	0.180	74.34	0.0198	48.86
9.50	100.00	0.150	72.84	0.0158	46.79
4.75	100.00	0.075	66.12	0.0116	45.32
				0.0082	44.13
				0.0059	40.05
				0.0042	38.63
				0.0027	35.90
				0.0021	34.59
				0.0012	32.56

APPENDIX E

90% DESIGN DRAWINGS

CITY OF STEINBACH LANDFILL EXPANSION - PHASE 2 ISSUED FOR REGULATORY REVIEW

SHEET LIST INDEX

SHEET NUMBER	SHEET TITLE
C101	EXISTING SITE PLAN
C102	PROPOSED PHASE 2 PLAN
C202	PROPOSED PHASE 2 CROSS SECTIONS
C301	DETAILS 1 of 3
C302	DETAILS 2 of 3
C303	DETAILS 3 of 3

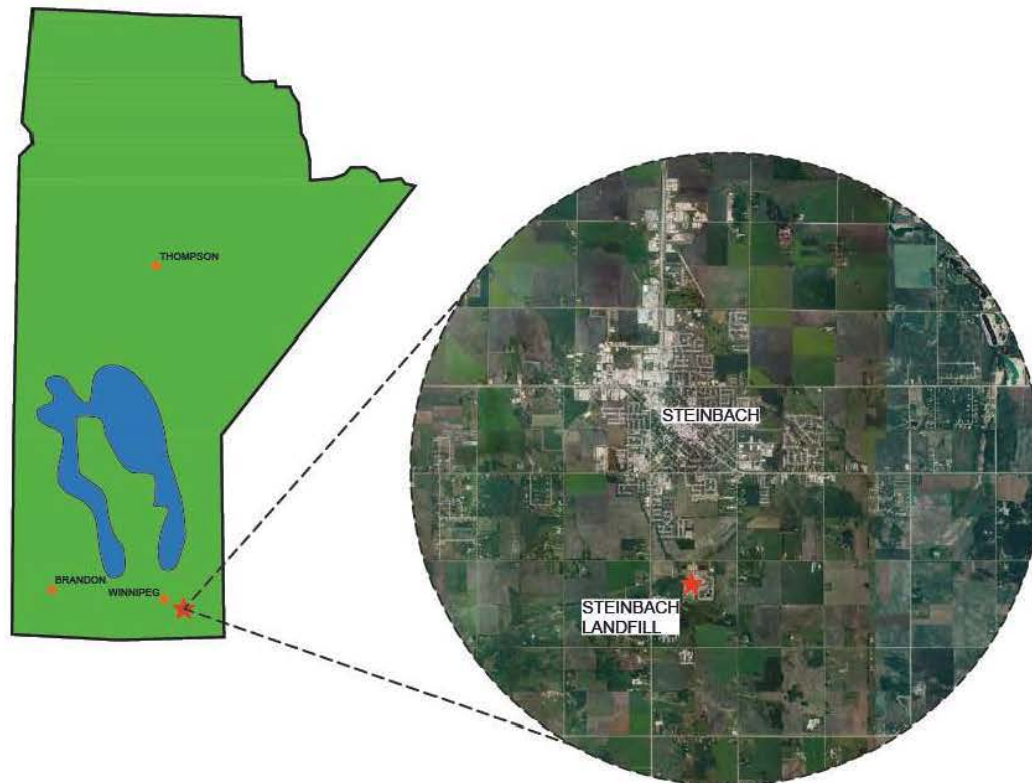

CITY PROJECT NO.: 2022-03
Steinbach, Manitoba





NUM	DATE	APR	DESCRIPTION
REVISIONS			
B	JUN 10/22	LQ	ISSUED FOR REVIEW - 90%
A	FEB 02/22	LQ	ISSUED FOR REVIEW - 30%
NUM	DATE	APR	DESCRIPTION
DRAWING STATUS			

PERMIT

PROFESSIONAL SEAL

CLIENT





**CITY OF STEINBACH LANDFILL PHASE 2 DESIGN
STEINBACH, MANITOBA**

EXISTING SITE PLAN

PROJECT No. SWM.CNMB0315T-01	OFFICE CGY	DES LQ	CKD WW	REV 0	DRAWING
DATE: June 2022	SHEET No. 1 of 6	DWN MM	APP LQ	STATUS B	C101

Q:\Information\enr\10_MASTERPROJECT_BASE_PLANS\Steinbach_Landfill\PROJECT\SS\MM.CNMB0315T-01_Phase_2\Production\SS\MM.CNMB0315T-01_C101.dwg [C:\] June 16, 2022 - 10:56:33.am [P:\ALBERTA\AME]

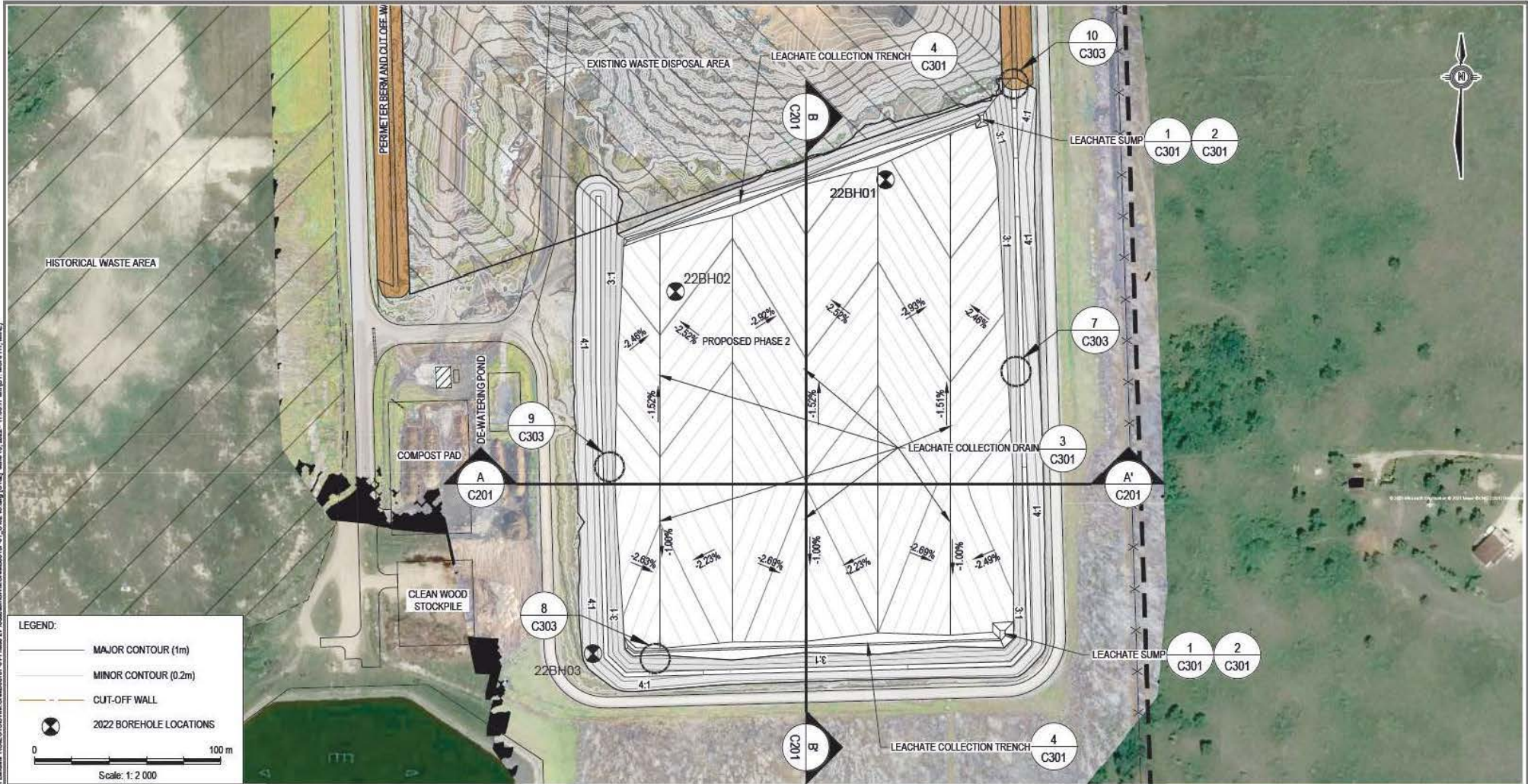
Q:\Environment\enrg\10_MASTERPROJECT_BASE_PLANS\Steinbach_Landfill\PROJECT\SSIM_C\MB03157-01_Phase 2\Production\SSIM_C\MB03157-01_C102.dwg [C:\] June 15, 2022 - 11:05:17 am BY: MURPHY, MRS



LEGEND:

- MAJOR CONTOUR (1m)
- MINOR CONTOUR (0.2m)
- CUT-OFF WALL
- 2022 BOREHOLE LOCATIONS

0 100 m
Scale: 1: 2 000

NUM	DATE	APR	DESCRIPTION
REVISIONS			
B	JUN 10/22	LQ	ISSUED FOR REVIEW - 90%
A	APR 28/22	LQ	ISSUED FOR REVIEW - 30%
NUM	DATE	APR	DESCRIPTION
DRAWING STATUS			

PERMIT

PROFESSIONAL SEAL

CLIENT





**CITY OF STEINBACH LANDFILL PHASE 2 DESIGN
STEINBACH, MANITOBA**

PROPOSED PHASE 2 PLAN

PROJECT No. SWM.CNMB03157-01	OFFICE CGY	DES LQ	CKD WW	REV 0	DRAWING
DATE: June 2022	SHEET No. 2 of 6	DWN MM	APP LQ	STATUS B	C102

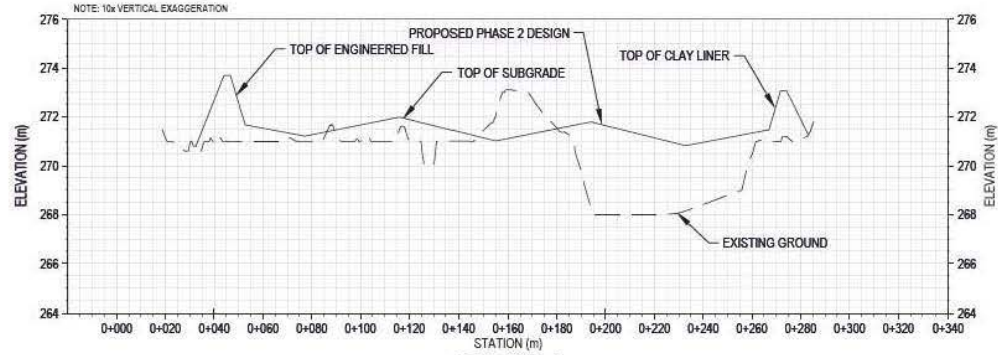
Q:\Environment\enrg\01_MASTERPROJECT_BASE_PLANS\Steinbach_Landfill\PROJECT\SS\MM_C\MB03157-01_Phase_2\production\SS\MM_C\MB03157-01_C102_01.dwg [2021 Jun 10, 2022 - 3:23:35 pm] (P:\MURPHY.MME)



SECTION A

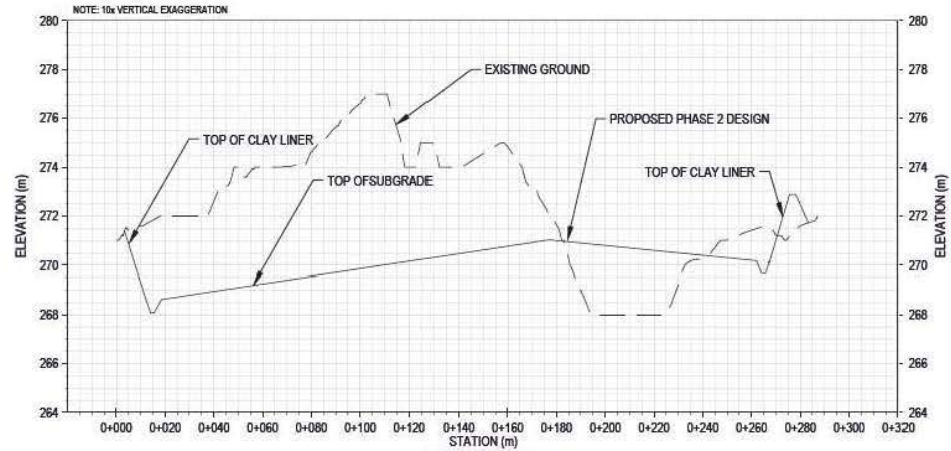

SECTION B

NUM	DATE	APR	DESCRIPTION
REVISIONS			
B	JUN 10/22	LQ	ISSUED FOR REVIEW - 90%
A	APR 28/22	LQ	ISSUED FOR REVIEW - 30%
NUM	DATE	APR	DESCRIPTION
DRAWING STATUS			

PERMIT

PROFESSIONAL SEAL

CLIENT



**CITY OF STEINBACH LANDFILL PHASE 2 DESIGN
STEINBACH, MANITOBA**

PROPOSED PHASE 2 CROSS SECTIONS

PROJECT No. SWM.CNMB03157-01	OFFICE CGY	DES LQ	CKD WW	REV 0	DRAWING
DATE: June 2022	SHEET No. 3 of 6	DWN MM	APP LQ	STATUS B	C201

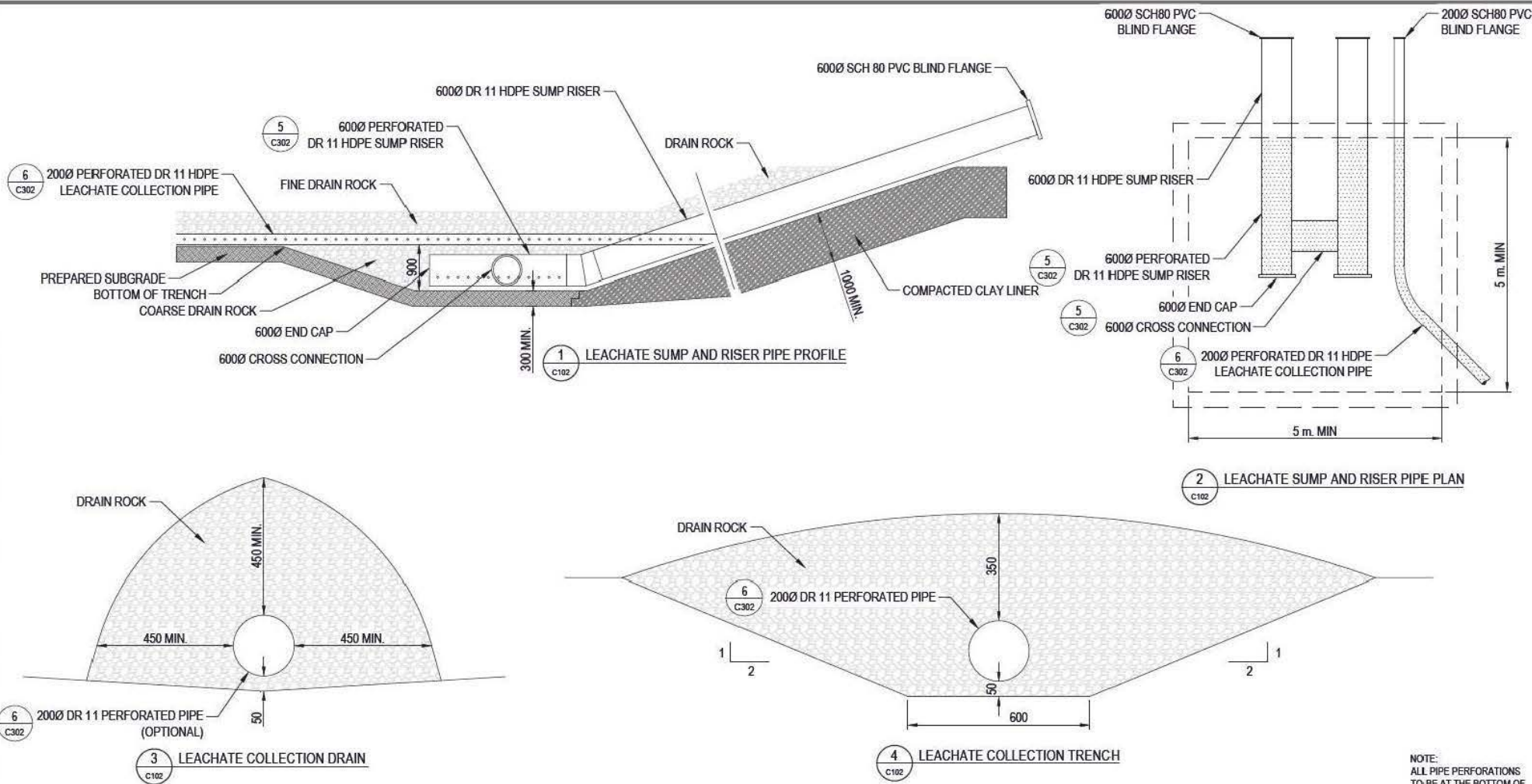

Q:\Information\enr\10_MASTERPROJECT_BASE_PLANS\Steinbach Landfill\PROJECT\SS\MM_C\MMB03157-01-Phase 2\Production\SWM\MMB03157-01_Details.dwg [C301] June 18, 2022 - 11:40:25am (P: MURPHY, MBE)



NOTE:
ALL PIPE PERFORATIONS
TO BE AT THE BOTTOM OF
THE PIPE

NUM	DATE	APR	DESCRIPTION
REVISIONS			
B	JUN 10/22	LQ	ISSUED FOR REVIEW - 90%
A	APR 28/22	LQ	ISSUED FOR REVIEW - 30%
NUM	DATE	APR	DESCRIPTION
DRAWING STATUS			

CLIENT





CITY OF STEINBACH LANDFILL PHASE 2 DESIGN
STEINBACH, MANITOBA

DETAILS 1 of 3

PROJECT No. SWM.CNMB03157-01	OFFICE EDM	DES LQ	CKD WW	REV 0	DRAWING
DATE: June 2022	SHEET No. 4 of 6	DWN RT	APP LQ	STATUS B	C301

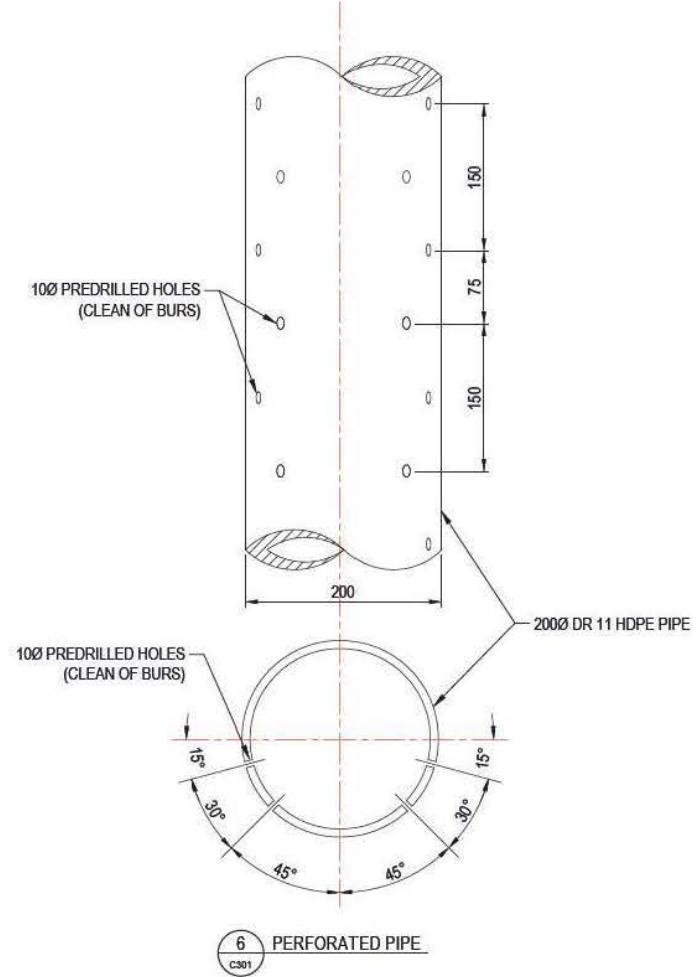
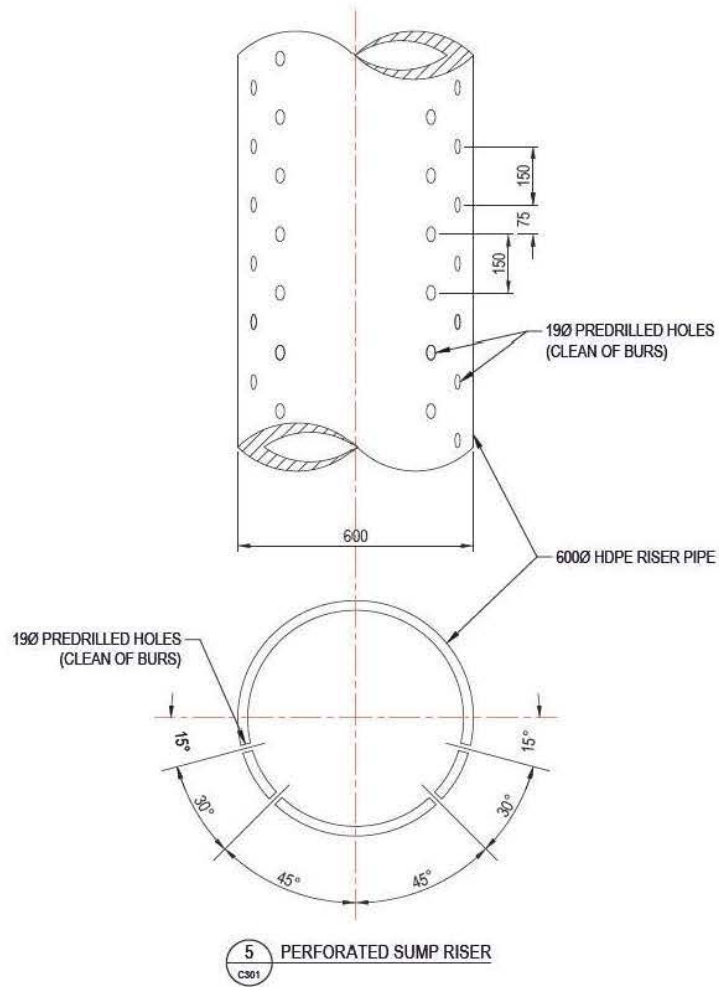
Q:\Environment\enrg\10_MASTERPROJECT_BASE_PLANS\Steinbach_Landfill\PROJECT\SS\MM_C\MMB03157-01_Phase 2\Production\SWM_C\MMB03157-01_Details.dwg (C302) June 18, 2022 - 11:42 am (By: MURPHY, MBE)



NUM	DATE	APR	DESCRIPTION
REVISIONS			
B	JUN 10/22	LQ	ISSUED FOR REVIEW - 90%
A	APR 28/22	LQ	ISSUED FOR REVIEW - 30%
NUM	DATE	APR	DESCRIPTION
DRAWING STATUS			

CLIENT



**CITY OF STEINBACH LANDFILL PHASE 2 DESIGN
STEINBACH, MANITOBA**

DETAILS 2 of 3

PROJECT No. SWM CMMB03157-01	OFFICE EDM	DES LQ	CKD WW	REV 0	DRAWING
DATE: June 2022	SHEET No. 5 of 6	DWN RT	APP LQ	STATUS B	C302

Q:\Environment\enrg\10_MASTERPROJECT_BASE_PLANS\Steinbach Landfill\PROJECT\SS\MM_C\MMB03157-01_Phase 2\production\MM_C\MMB03157-01_Details.dwg (2/28) June 18, 2022 - 11:11:20 am (P: MURPHY, MBE)

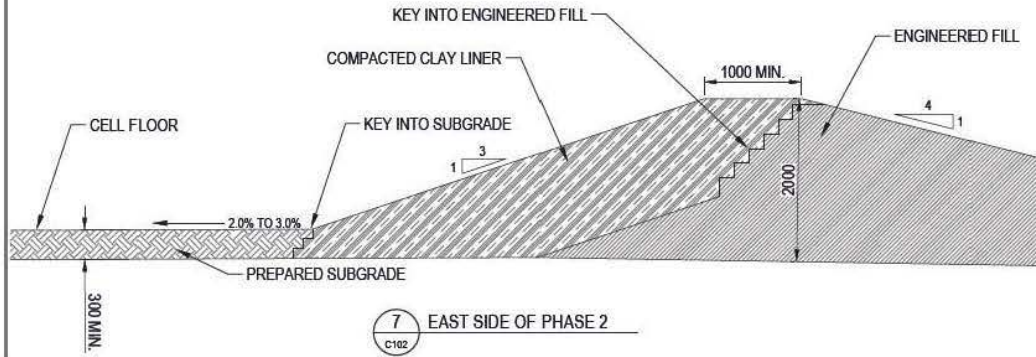

7 EAST SIDE OF PHASE 2
C102

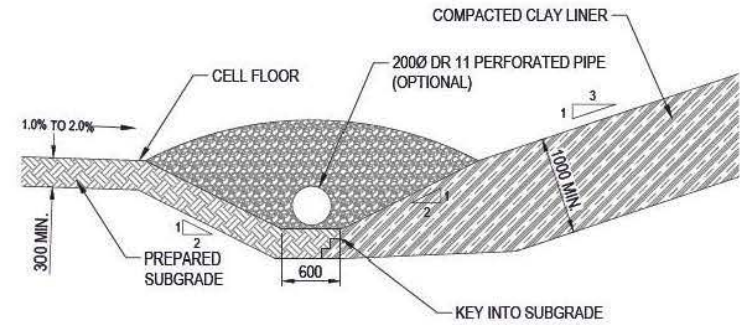

8 SOUTH SIDE OF PHASE 2
C102

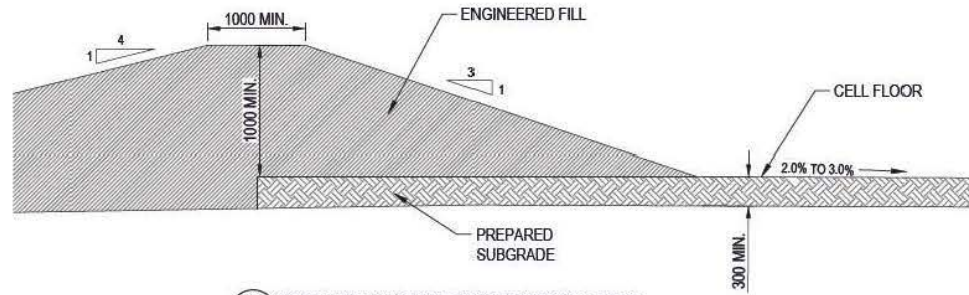

9 WEST SIDE OF PHASE 2 INTERMEDIATE BERM
C102

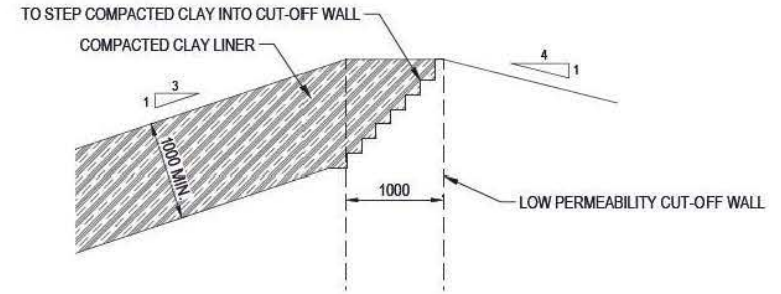

10 TIE INTO PHASE 1
C102

NUM	DATE	APR	DESCRIPTION
REVISIONS			
B	JUN 10/22	LQ	ISSUED FOR REVIEW - 90%
A	APR 28/22	LQ	ISSUED FOR REVIEW - 30%
NUM	DATE	APR	DESCRIPTION
DRAWING STATUS			

CLIENT



CITY OF STEINBACH LANDFILL PHASE 2 DESIGN
STEINBACH, MANITOBA

DETAILS 3 of 3

PROJECT No. SWM CMMB03157-01	OFFICE EDM	DES LQ	CKD WW	REV 0	DRAWING
DATE: June 2022	SHEET No. 6 of 6	DWN MM	APP LQ	STATUS B	C303

Yazon, Edwin (CC)

From: Quan, Lauren <Lauren.Quan@tetrattech.com>
Sent: July 25, 2022 2:43 PM
To: Yazon, Edwin (CC)
Cc: Eldon Wallman; Aaron Rach; Heckert, Kara; Wood, William
Subject: RE: File 5332.00 - Steinbach Landfill Phase 2 Expansion - Request for Additional Information

Hello Edwin,

Thank you for meeting with us this afternoon. My understanding is that we should expect to hear from you tomorrow to confirm the understanding reached during the meeting:

- A cut-off wall liner was constructed around the entire landfill expansion (Phase 1 and Phase 2) area during the 2010 construction.
- As the cut-off wall was previously constructed and tested, Manitoba Environment, Climate, and Parks does not require any additional compacted clay liner in the Phase 2 area.

The City was able to obtain a copy of the previously submitted report on the 2009 supplemental hydrogeological test program. We understand that this information was previously submitted to the Ministry as a response to comments on the City's Environment Act Proposal. We can provide a copy of this report if it is helpful.

Please let me know if there is any other information you require.

Thank you,
Lauren

Lauren Quan, P.Eng. | Lead, Manitoba Solid Waste Management
Direct +1 (204) 954-6850 | Mobile +1 (204) 688-4928 | Lauren.Quan@tetrattech.com

This message, including any attachments, may include privileged, confidential and/or inside information. Any distribution or use of this communication by anyone other than the intended recipient is strictly prohibited and may be unlawful. If you are not the intended recipient, please notify the sender by replying to this message and then delete it from your system.

From: Quan, Lauren
Sent: Thursday, July 21, 2022 4:02 PM
To: Yazon, Edwin (CC) <Edwin.Yazon@gov.mb.ca>
Cc: Eldon Wallman <ewallman@steinbach.ca>; Aaron Rach <aaron.rach@steinbach.ca>; Heckert, Kara <KARA.HECKERT@tetrattech.com>; Wood, William <William.Wood@tetrattech.com>
Subject: RE: File 5332.00 - Steinbach Landfill Phase 2 Expansion - Request for Additional Information

Hello Edwin,

Thank you for responding to this submission. We would like to meet to discuss the proposed approach at your earliest convenience. Are there any times that you are available on Friday (July 22) or Monday (July 25)?

The City of Steinbach has identified that they received approval from Manitoba Conservation to construct their Phase 1 landfill without a 1 meter clay liner. The City is working with Dillon Consulting to retrieve this previous correspondence. We believe that an expanded hydrogeological testing program was submitted to Manitoba Conservation in 2009 to demonstrate the equivalency of the clays underlying the landfill in support of this approach.

Thank you,

Lauren

Lauren Quan, P.Eng. | Lead, Manitoba Solid Waste Management
Direct +1 (204) 954-6850 | Mobile +1 (204) 688-4928 | Lauren.Quan@tetrattech.com

This message, including any attachments, may include privileged, confidential and/or inside information. Any distribution or use of this communication by anyone other than the intended recipient is strictly prohibited and may be unlawful. If you are not the intended recipient, please notify the sender by replying to this message and then delete it from your system.

From: Yazon, Edwin (CC) <Edwin.Yazon@gov.mb.ca>
Sent: Wednesday, July 20, 2022 1:55 PM
To: Quan, Lauren <Lauren.Quan@tetrattech.com>
Cc: Eldon Wallman <ewallman@steinbach.ca>; Aaron Rach <aaron.rach@steinbach.ca>; Heckert, Kara <KARA.HECKERT@tetrattech.com>; Wood, William <William.Wood@tetrattech.com>
Subject: RE: File 5332.00 - Steinbach Landfill Phase 2 Expansion - Request for Additional Information

⚠ CAUTION: This email originated from an external sender. Verify the source before opening links or attachments. **⚠**

Good afternoon Lauren,

May apology for the late response. I was on holidays in the last two weeks. Below is my response to your comments.

While the licence of the site or the regulation does not specify the one metre clay liner requirement, it was (and it is) the standard best practice to use one metre clay liner (e.g. wastewater treatment lagoon, earthen manure storage) for waste containment. I checked the record drawing of Phase 1 (attached), and it was constructed with one metre clay liner.

We would require that Phase 2 expansion be constructed with one metre floor clay liner (similar to Phase 1), including the slopes of the east and south perimeter berms. The cut areas must tie into the same one metre clay unit of the cell bottom of Phase 1.

We can discuss as necessary.

Sincerely,

Edwin Yazon, P. Eng.
Environmental Engineer, Environmental Approvals
Environment, Climate and Parks
Edwin.Yazon@gov.mb.ca / Cel: 431-335-2554
1007 Century St., Winnipeg, MB R3H 0W4

Facts are key in the fight against COVID-19, visit [Manitoba.ca/covid-19](https://www.manitoba.ca/covid-19)

To report an Environmental Emergency please call our
24/7 Environmental Emergency Response Line (204) 944-4888
Toll Free in Manitoba 1-855-944-4888

From: Quan, Lauren <Lauren.Quan@tetrattech.com>
Sent: June 28, 2022 7:09 PM
To: Yazon, Edwin (CC) <Edwin.Yazon@gov.mb.ca>

Cc: Eldon Wallman <ewallman@steinbach.ca>; Aaron Rach <aaron.rach@steinbach.ca>; Heckert, Kara <KARA.HECKERT@tetrattech.com>; Wood, William <William.Wood@tetrattech.com>

Subject: RE: File 5332.00 - Steinbach Landfill Phase 2 Expansion - Request for Additional Information

CAUTION: This email originated from an External Sender. Please do not click links or open attachments unless you recognize the source.

ATTENTION: ce courriel provient d'un expéditeur externe. Ne cliquez sur aucun lien et n'ouvrez pas de pièce jointe, excepté si vous connaissez l'expéditeur.

Hello Edwin,

Thank you for the very prompt review of the City's submission. I have answered your questions below and am happy to discuss further.

- Please confirm the floor thickness of the clay liner for phase 2 expansion. The drawing indicates 300 mm only. The Standards for Landfill document requires 1 m of clay liner.
 - Liner thickness is intended to be:
 - 1 m perpendicular to the slope on the east and south perimeter berms which will form the perimeter of the final landfill development.
 - 1 m where fill is required to reach the desired grade.
 - 300 mm of subgrade preparation to clay liner standards is specified both below clay liner and where cut is required to reach the desired grade. The cut areas are tying into the same clay unit that was previously approved as the cell bottom for the Phase 1 area.
 - Is there a specific section that refers to the requirement for a 1 m thickness of clay liner for Class 1 WDGs? My understanding is the Standards for Landfills in Manitoba specify:
 1. 1 metre thick (perpendicular) liner on above grade berms to 1 m above expected leachate level (section 4.2.1).
 2. 1 metre thick liner for compacted clay lined cells - below grade OR 75 years TOT to groundwater for cut and fill cells at Class 2 and Class 3 WDGs (section 4.2.2).
 3. 1 metre thick clay OR compacted clay for sites designed to include a leachate containment system provided that the material meets the minimum $1 \text{ E}^{-7} \text{ cm/s}$ (section 4.2.4).
 - The site's EAL (No. 2918RR) does not require a clay liner in waste disposal cells. By contrast a clay liner is required in storm water retention and sedimentation ponds and the compost facility.
 - The Phase 1 area was developed based on the original site investigation report which calculated TOT to the usable aquifer at 189 years and only recommended the construction of a perimeter cut-off wall to isolate waste from the surficial sand/gravel layers known observed at the perimeter of the proposed landfill footprint. The City was required to provide soil samples from this cut-off wall. We propose a similar approach for Phase 2 but suggest that a more consistent and reliable clay liner can be constructed on the surface of the perimeter berm rather than as a vertical cut-off wall down the middle of the berm.
- Phase 2 expansion is designed with three leachate trenches with approx. 78 m spacing. The submission describes only two trenches – northern terminus and southern terminus trenches. Drawing 301 also indicates two trenches only.
 - Sorry, that's just a wording difference between the report and the drawings. Section 5.3 of the report can be reworded to refer to three leachate drains leading to two trenches. The three leachate drains run north/south at a spacing of approximately 78 m and two leachate trenches run east/west into the leachate sumps.
- Please include the borrow pit area in the drawing.
 - Approximate outline of the borrow pit is shown in the attached drawing. We can show this on the design set if needed.

- What is the purpose of the septage dewatering area? Please provide more information about septage dewatering?
 - This is a previously approved area that was designed/constructed/approved as a component of the Phase 1 development. The area is used for curb and gutter liquid as well as collection pits from car washes, sucker pump projects, etc. It won't be changed as a component of the proposed construction.

I would be happy to clarify any points at your convenience.

Thank you,
Lauren

Lauren Quan, P.Eng. | Lead, Manitoba Solid Waste Management
Direct +1 (204) 954-6850 | Mobile +1 (204) 688-4928 | Lauren.Quan@tetrattech.com

This message, including any attachments, may include privileged, confidential and/or inside information. Any distribution or use of this communication by anyone other than the intended recipient is strictly prohibited and may be unlawful. If you are not the intended recipient, please notify the sender by replying to this message and then delete it from your system.

From: Yazon, Edwin (CC) <Edwin.Yazon@gov.mb.ca>
Sent: Tuesday, June 28, 2022 9:25 AM
To: Quan, Lauren <Lauren.Quan@tetrattech.com>; Wood, William <William.Wood@tetrattech.com>; Eldon Wallman <ewallman@steinbach.ca>; Aaron Rach <aaron.rach@steinbach.ca>; Heckert, Kara <KARA.HECKERT@tetrattech.com>
Subject: File 5332.00 - Steinbach Landfill Phase 2 Expansion - Request for Additional Information

⚠ CAUTION: This email originated from an external sender. Verify the source before opening links or attachments. ⚠

Good morning,

I have reviewed your submission requesting a phase 2 expansion of the Steinbach landfill. Please clarify/provide the following information:

- Please confirm the floor thickness of the clay liner for phase 2 expansion. The drawing indicates 300 mm only. The Standards for Landfill document requires 1 m of clay liner.
- Phase 2 expansion is designed with three leachate trenches with approx. 78 m spacing. The submission describes only two trenches – northern terminus and southern terminus trenches. Drawing 301 also indicates two trenches only.
- Please include the borrow pit area in the drawing.
- What is the purpose of the septage dewatering area? Please provide more information about septage dewatering?

Sincerely,

Edwin Yazon, P. Eng.
Environmental Engineer, Environmental Approvals
Environment, Climate and Parks
Edwin.Yazon@gov.mb.ca / Cel: 431-335-2554
1007 Century St., Winnipeg, MB R3H 0W4

Facts are key in the fight against COVID-19, visit Manitoba.ca/covid-19

To report an Environmental Emergency please call our
24/7 Environmental Emergency Response Line (204) 944-4888
Toll Free in Manitoba 1-855-944-4888

C:\Users\William.WoodOneDrive - Tetra Tech, Inc\Documents\Steinbach Landfill_Manitoba\SWM.ONMB03157-01_Fig1-3_GW Plan and Sections.dwg [FIGURE 1] May 05, 2022 - 10:28:33 am (BY: WOOD, WILLIAM)



LEGEND:

- MAJOR CONTOUR (1m)
- MINOR CONTOUR (0.2m)
- CUT-OFF WALL
- MONITORING WELL
- BOREHOLE

0 100 m
Scale: 1: 2 000

NUM	DATE	APR	DESCRIPTION
REVISIONS			
A	APR 28/22	LQ	ISSUED FOR REVIEW - 30%
NUM	DATE	APR	DESCRIPTION
DRAWING STATUS			

CLIENT





**CITY OF STEINBACH LANDFILL PHASE 2 DESIGN
STEINBACH, MANITOBA**

**PHASE 2 EXPANSION SHOWING
PREVIOUS BORROW AREA**

PROJECT No. SWM.ONMB03157-01	OFFICE EDM	DES LQ	CKD WW	REV -	DRAWING
DATE: April 2022	SHEET No. 1 of 3	DWN DRG	APP LQ	STATUS -	FIGURE 1

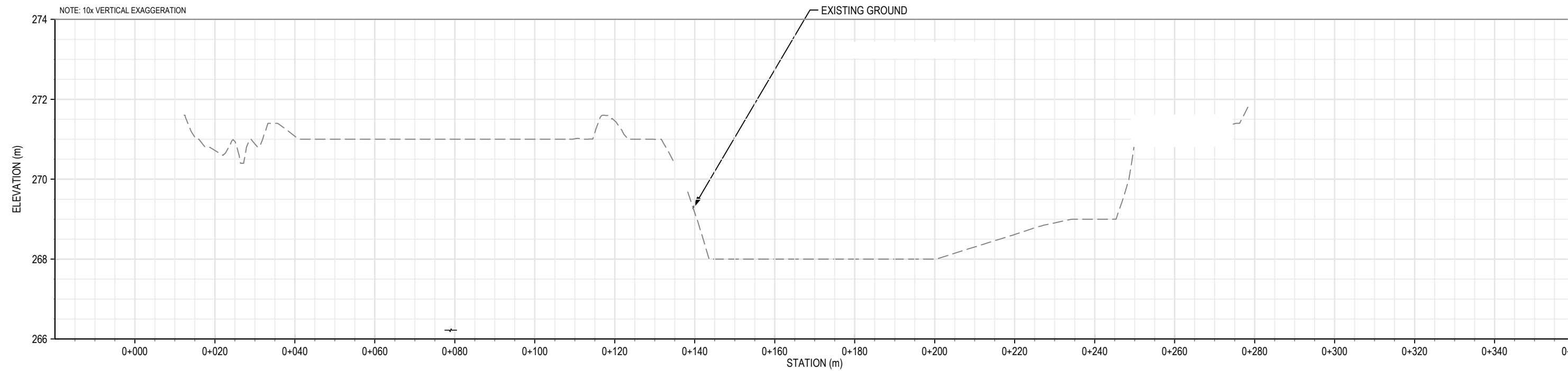
C:\Users\William.WoodOneDrive - Tetra Tech\Incl\Documents\Steinbach Landfill\Manitoba\SWM.ONMB03157-01_Fig.3_GW Plan and Sections.dwg [FIGURE 2] May 05, 2022 - 10:28:54 am (BY: WOOD, WILLIAM)



SECTION A

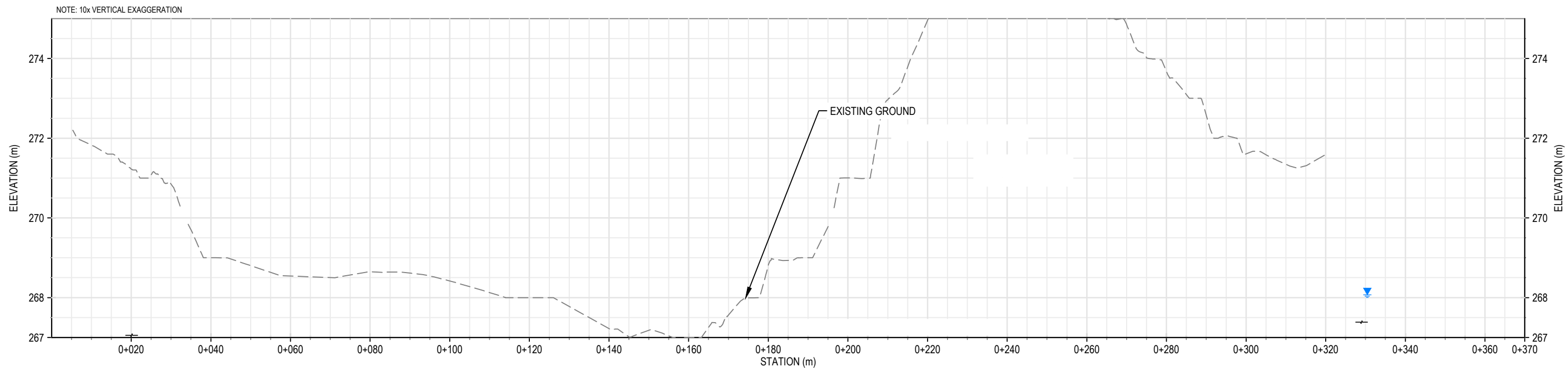

SECTION B

CLIENT



**CITY OF STEINBACH LANDFILL PHASE 2 DESIGN
STEINBACH, MANITOBA**

**PROPOSED PHASE 2
CROSS SECTIONS A AND B**



PROJECT No. SWM.ONMB03157-01	OFFICE EDM	DES LQ	CKD WW	REV -	DRAWING
DATE: April 2022	SHEET No. 2 of 3	DWN DRG	APP LQ	STATUS -	FIGURE 2

C:\Users\William.WoodOneDrive - Tetra Tech\Incl\Documents\Steinbach Landfill\Manitoba\SWM.ONMB03157-01_Fig.3_GW Plan and Sections.dwg [FIGURE 3] May 05, 2022 - 10:29:12 am (BY: WOOD, WILLIAM)

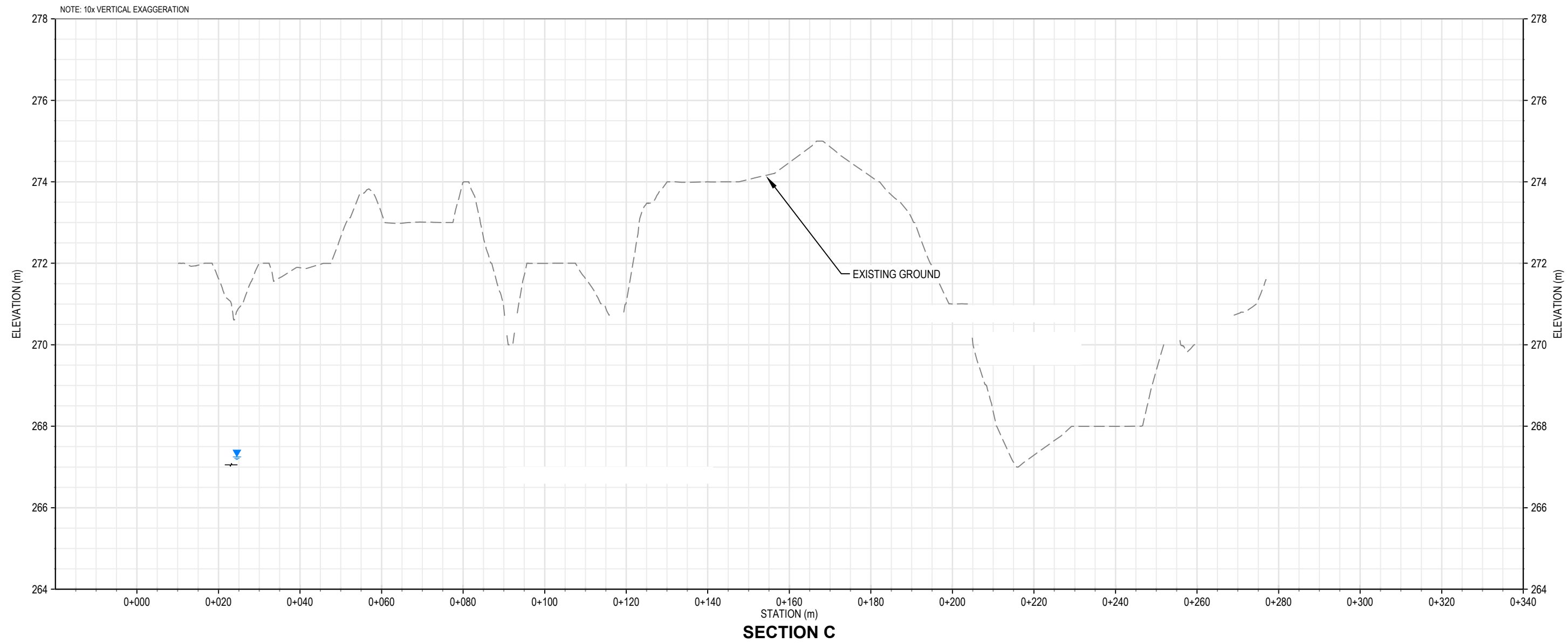

CLIENT



**CITY OF STEINBACH LANDFILL PHASE 2 DESIGN
STEINBACH, MANITOBA**

**PROPOSED PHASE 2
CROSS SECTION C**



PROJECT No. SWM.ONMB03157-01	OFFICE EDM	DES LQ	CKD WW	REV -	DRAWING
DATE: April 2022	SHEET No. 3 of 3	DWN DRG	APP LQ	STATUS -	FIGURE 3