PHASE 2 Technical Memorandum for Red and Assiniboine Ammonia Criteria Study

From: S. Davies
Task Leader, Fish Habitat Workstream

To: City of Winnipeg Project Management Committee
Study Team Members

Subject: **Fish Habitat Technical Memorandum # FH 03**

Title: **WATER CHEMISTRY DATA TO CHARACTERIZE FISH
HABITAT IN THE RED AND ASSINIBOINE RIVERS**

Prepared by: S. Davies and J. Toews

January, 2000

EXECUTIVE SUMMARY

This memorandum is one of a series of three memoranda that have been produced to describe fish habitat in the Red and Assiniboine rivers within the City of Winnipeg Ammonia Criteria Study Area. This document describes the water chemistry component of fish habitat, while two other memoranda describe the physical attributes and benthic invertebrate community. Data from all three memoranda will be used to explain fish distributions within the Study Area.

The objective of this study was to document the water chemistry of those portions of the Red and Assiniboine rivers within the Study Area. The focus of the study was to provide information to describe regional (zone) differences in habitats (macrohabitats) to contribute to explaining potential regional differences in fish distributions.

Three surveys were conducted to describe water chemistry in the Red and Assiniboine rivers. The first sampling period took place during February - March, 1999, the second during July, 1999, and the third during September, 1999. A water chemistry sampling program was developed using the segments previously designated by the physical habitat surveys. The Red and Assiniboine rivers had been divided into five major zones, which were divided further into 86 and 30 segments, respectively.

For all three sampling periods, water chemistry data were collected at each of the fish sampling sites. All tributaries to the Red and Assiniboine rivers in the Study Area, and the mixing zones downstream of the Water Pollution Control Centre (WPCC) effluent outfalls, were also sampled during the second and third periods. Water chemistry data are presented by river segment within each of the major zones.

Water chemistry data collected in the Red and Assiniboine rivers during the open water period of 1999 were gathered under conditions of very high stream discharge. During the autumn sampling period, stream discharges of both rivers were the highest on record. In winter, ammonia was elevated above background concentrations at sites downstream of the WPCCs, with the highest concentrations occurring in Zone 3. Elevated ammonia concentrations downstream of the WPCCs were less evident in summer and autumn, likely due to the breakdown of ammonia by biological processes. The Manitoba Surface Water

Quality Objective (MSWQO) for dissolved oxygen for the protection of cool water species is 47 % saturation (Williamson 1988). All dissolved oxygen measurements made in the Red and Assiniboine rivers in winter, summer, and autumn, 1999, met the MSWQO guideline, with the exception of a single measurement at Segment 59 (within the NEWPCC mixing zone) on July 13.

TABLE OF CONTENTS

	<u>Page</u>
1.0 INTRODUCTION	1
2.0 METHODS	2
2.1 STUDY AREA	2
2.2 WINTER SAMPLING	2
2.3 SUMMER AND AUTUMN SAMPLING	3
2.4 SAMPLING WITHIN THE MIXING ZONE OF THE NEWPCC	4
3.0 RESULTS AND DISCUSSION	5
3.1 RED RIVER	12
3.2 ASSINIBOINE RIVER	52
4.0 REFERENCES	7

List of Tables

	<u>Page</u>
Table 1. Summary of total ammonia nitrogen concentrations measured as part of the Ammonia Criteria Study, 1999	8

List of Figures

	<u>Page</u>
Figure 1. Study Area for the City of Winnipeg Ammonia Criteria Study	9
Figure 2. Fish habitat survey segments on the Red River south of the Forks and on the Assiniboine River	10
Figure 3. Fish habitat survey segments on the Red River north of the Forks	11

Figure 4.	Red River segments 1-5	13
Figure 5.	Red River segments 6-11	16
Figure 6.	Red River segments 11-15	18
Figure 7.	Red River segments 16-21	19
Figure 8.	Red River segments 19-26	22
Figure 9.	Red River segments 25-30	24
Figure 10.	Red River segments 30-35	26
Figure 11.	Red River segments 36-40	28
Figure 12.	Red River segments 41-46	30
Figure 13.	Red River segments 46-51	32
Figure 14.	Red River segments 51-55	34
Figure 15.	Red River segments 56-60	37
Figure 16.	Red River segments 61-65	41
Figure 17.	Red River segments 66-70	44
Figure 18.	Red River segments 71-75	46
Figure 19.	Red River segments 76-80	48
Figure 20.	Red River segments 80-86	50

Figure 21.	Assiniboine River segments 101-105	53
Figure 22.	Assiniboine River segments 106-110	55
Figure 23.	Assiniboine River segments 111-117	58
Figure 24.	Assiniboine River segments 116-120	60
Figure 25.	Assiniboine River segments 121-125	63
Figure 26.	Assiniboine River segments 126-130	66
Figure 27.	Comparison of historical discharge data with 1999 data for the Red River at Emerson, Manitoba	68
Figure 28.	Comparison of historical discharge data with 1999 data for the Red River at Lockport, Manitoba	69
Figure 29.	Comparison of historical discharge data with 1999 data for the Assiniboine River at Headingley, Manitoba	70

List of Appendices

	<u>Page</u>
Appendix 1. Summary of on-site measurements taken during sampling in the vicinity of the NEWPCC outfall, March, 1999	71
Appendix 2. Summary of on-site measurements taken during sampling in the vicinity of the NEWPCC outfall, October, 1999	73

1.0

INTRODUCTION

Fish distribution, abundance, and health are dependent on the quality and quantity of habitat. Fish habitat is generally a function of physical (i.e., substrate, water depth, water velocity, and riparian conditions), chemical (i.e., dissolved oxygen, turbidity, water temperature, pH, and ammonia concentration), and/or biological (i.e., benthic invertebrate community abundance and composition) factors. To explain differences in distribution, abundance, and condition of fish inhabiting various locations, we must have an understanding of how habitat parameters differ among those sites.

This technical memorandum is one of a series of three memoranda that have been prepared to describe fish habitat within the City of Winnipeg Ammonia Criteria Study Area (Figure 1) and contribute to the understanding of fish distributions in the Red and Assiniboine rivers. This document describes the water chemistry component, including measurements of pH, conductivity, turbidity, dissolved oxygen, water temperature, and ammonia concentration. A description of the physical attributes and biological components of fish habitat in the Red and Assiniboine rivers within the Study Area are provided in two other technical memoranda entitled:

Fish Habitat Technical Memorandum #FH 01: Physical Data to Characterize Fish Habitat in the Red and Assiniboine Rivers.

Fish Habitat Technical Memorandum #FH 02: Benthic Invertebrate and Sediment Data to Characterize Fish Habitat in the Red and Assiniboine Rivers.

The primary objective of this portion of the study was to document the basic water chemistry of those portions of the Red and Assiniboine rivers that lie within the Study Area for the City of Winnipeg Ammonia Criteria Study. The focus of the study was to provide information to describe regional (zone) differences in habitats (macrohabitats), which would assist in explaining potential regional differences in fish distributions.

2.0

METHODS

2.1 STUDY AREA

The study area for the City of Winnipeg Ammonia Criteria Study is shown in Figures 1 - 3. The study area is divided into five major zones, which are divided further into segments. Two additional zones were used as controls for some components of the Ammonia Criteria Study. A description of the extent of each zone is as follows:

- C Zone 1A - extends between Ste. Agathe and St. Adolphe on the Red River and was used as a control area for the summer and autumn sampling periods;
- C Zone 1 - extends from St. Adolphe to the South End Water Pollution Control Centre (SEWPCC) on the Red River;
- C Zone 2 - extends from the SEWPCC to the North End WPCC (NEWPCC) on the Red River;
- C Zone 3 - extends from the NEWPCC to the St. Andrews Locks near the town of Lockport on the Red River;
- C Zone 3A - extends from the St. Andrews Locks at Lockport to downstream of the City of Selkirk on the Red River;
- C Zone 4 - extends from the West End WPCC (WEWPCC) on the Assiniboine River to the confluence of the Assiniboine and Red rivers; and,
- C Zone 5 - extends from Headingley to the WEWPCC on the Assiniboine River.

2.2 WINTER SAMPLING

Water chemistry data were collected from February 24 to March 11, 1999 as part of the Fish Habitat component of the Ammonia Criteria Study. Water chemistry data were collected at each site at which a gill net was set, using the holes drilled through the ice for the nets. Measurements were made at both ends of each gill net to provide information on any variation in ammonia concentrations along the length of the net.

Measurements of pH, conductivity (corrected to 25 EC), turbidity, dissolved oxygen, and temperature were made with a Horiba® U-10 Water Quality Checker (Horiba® Ltd., Kyoto,

Japan). At selected sites, measurements were made near the river bottom and at the bottom edge of the ice (referred to as surface measurements). At all other sites, measurements were made 1 m below the bottom of the ice.

Ammonia analysis was performed on 10 ml aliquots of water collected from the river surface. When sampling through ice, the water was mixed vertically to avoid contamination by meltwater from the ice. Immediately upon collection, each sample was fixed for ammonia analysis with a Palintest[®] reagent system (a tablet reagent system based on the indophenol method). Fixed samples were stored in the dark until analysed at the end of the day with a Palintest[®] 5000 spectrophotometer (Palintest[®] Ltd., Tyne & Wear, England). For samples that required dilution, dilution was performed in the field, by adding aliquots of sample into pre-measured volumes of tap water. The tap water was analysed to ensure that it contained no measurable ammonia.

Unionized ammonia for all samples was calculated using the following equation:

$$\text{NH}_3 \text{ (mg NH}_3\text{/L)} = \text{total ammonia (mg/L)} / 10^{(0.09018 + (2729.92 / (273.16 + \text{temperature(}^\circ\text{C)})) - \text{pH}) + 1}$$

2.3 SUMMER AND AUTUMN SAMPLING

Water chemistry data were collected from July 8 to 27 and from September 8 to 19, 1999 as part of the Fish Habitat component of the Ammonia Criteria Study. Measurements were made from an anchored boat.

As in the winter sampling, measurements were made at each gillnet site, but only one set of measurements was made at each site, at a point near the middle of each net. All tributaries to the Red and Assiniboine rivers in the study area were sampled. Measurements were made in the mixing zones downstream of the Water Pollution Control Centre (WPCC) effluent outfalls to determine the spatial extent of elevated ammonia levels within the mixing zones.

Measurements of pH were made at the water's surface with a handheld Oakton[®] Model 35624-35 pH Wand[®]. Turbidity was measured at the surface with a Hach[®] Model 2100P portable turbidimeter (Hach[®] Company, Loveland, Co, USA). All other *in situ*

measurements were made at mid-depth. Dissolved oxygen was measured with a YSI Model 95 handheld meter (YSI Corporation, OH, USA). Conductivity (corrected to 25EC) and temperature were measured with a YSI Model 30 handheld meter.

Surface samples were collected and immediately preserved for ammonia analysis using the same Palintest[®] system used in the winter sampling program.

2.4 SAMPLING WITHIN THE MIXING ZONE OF THE NEWPCC

As part of the Fish Behaviour component of the Ammonia Criteria Study, sampling within the mixing zone of the NEWPCC effluent outfall was performed in March and October, 1999. All measurements were made from an anchored boat.

Measurements of dissolved oxygen, temperature, and pH were made at various depths using the Horiba[®] U-10 meter. Water samples were collected for ammonia analysis from discrete depths with a 1.5 L Kemmerer sampler. Aliquots of each sample were fixed for ammonia analysis with the Palintest[®] system.

3.0 RESULTS AND DISCUSSION

Table 1 summarizes the ammonia data collected from Zone 1A to Zone 5 in winter, summer, and autumn of 1999. Water chemistry data collected as part of the Fish Habitat component of the Ammonia Criteria Study are presented in tabular format by river segment within each of the major zones. Maps to illustrate where data were collected are provided in Figures 4 - 26. Water chemistry data from sampling in the mixing zone of the NEWPCC have been presented in Lawrence (1999) and Lawrence and Barth (2000). The water chemistry data collected in these studies are presented in Appendix 1 (study conducted in March, 1999) and Appendix 2 (study conducted in October, 1999) of this report.

Water chemistry data collected in the Red and Assiniboine rivers during the open water period of 1999 were collected under conditions of very high stream discharge. During July, discharge in the Red and Assiniboine rivers (provisional weekly data provided by Manitoba Conservation, Water Resources Branch) was approximately 2.5 and 3 times, respectively, the historical mean monthly mean discharges (Figures 27 - 29; Environment Canada 1991). During the autumn sampling period, stream discharge of the Red and Assiniboine rivers (provisional weekly data provided by Manitoba Conservation, Water Resources Branch) were the highest on record (Figures 27 - 29; Environment Canada 1991).

Ammonia concentrations were highest in winter, which is expected, as cold temperatures and reduced light in the water column during winter reduce the abundance and activity of bacteria and phytoplankton (algae in the water column), which remove ammonia from the water. In winter, ammonia was elevated above background concentrations at sites downstream of the WPCCs, with the highest concentrations occurring in Zone 3. Elevated ammonia concentrations downstream of the WPCCs were less evident in summer and autumn, likely due to the uptake of ammonia from the river by biological processes.

Three sets of measurements taken in Zone 3 on March 8, 1999 showed higher than anticipated ammonia concentrations. The higher values occurred at Segment 72 (1 measurement) and Segment 74 (both measurements). Under the pH and temperature conditions at these sites at the time, the unionized ammonia concentrations were 0.0246 mg/L at Segment 72 and 0.0223 mg/L and 0.0190 mg/L at Segment 74. Other winter

measurements made in Zone 3 were lower.

The Manitoba Surface Water Quality Objective (MSWQO) for dissolved oxygen for the protection of cool water species is 47 % saturation (Williamson 1988). All measurements made in the Red and Assiniboine rivers in winter, summer, and autumn, 1999, were above this value, with the exception of a single measurement of 3.78 mg/L (46% saturation), which occurred at Segment 59 (within the NEWPCC mixing zone) on July 13.

4.0

REFERENCES

Environment Canada. 1991. Historical Streamflow Summary to 1990. Inland Waters Directorate. Ottawa, Canada. 301 p.

LAWRENCE, M. 1999. Biological and Environmental Data from Experimental Gillnetting in the Vicinity of the NEWPCC Outfall, March, 1999. Fish Behaviour Technical Memorandum # FB 01 submitted to the City of Winnipeg Project Management Committee by North/South Consultants Inc.

LAWRENCE, M. and C.C. BARTH. 2000. Biological and Environmental Data from Experimental Gillnetting in the Vicinity of the NEWPCC Outfall, October, 1999. Fish Behaviour Technical Memorandum # FB 02 submitted to the City of Winnipeg Project Management Committee by North/South Consultants Inc.

WILLIAMSON, D.A. 1988. Manitoba Surface Water Quality Objectives. A Water Standards and Studies Report. 47 p.

Table 1. Summary of total ammonia nitrogen concentrations measured as part of the Ammonia Criteria Study, 1999.

Zone	Winter			Summer			Autumn		
	Median	Range	n	Median	Range	n	Median	Range	n
1A				0.01	0.00 - 0.01	3	0.05	0.01 - 0.17	3
1	0.11	0.09 - 0.14	24	0.04	0.01 - 0.07	3	0.01	0.00 - 0.01	3
2	0.32	0.03 - 0.47	25	0.03	0.00 - 0.08	10	0.15	0.11 - 0.47	6
3	1.80	1.00 - 2.35	8	0.04	0.00 - 0.29	6	0.13	0.06 - 0.36	6
3A	1.00	0.77 - 1.36	12	0.11	0.11 - 0.12	3	0.11	0.02 - 0.27	3
5	0.05	0.03 - 0.06	6	0.03	0.01 - 0.05	2	0.00	0.00 - 0.00	2
4	0.34	0.09 - 0.77	9	0.05	0.02 - 0.13	5	0.09	0.04 - 0.11	3

Ammonia concentrations are expressed in mg nitrogen per litre;

n = number of observations (the number of observations is in most cases highest in winter because two measurements were made at each gillnet site, while only one measurement was made per site in summer and autumn);

Winter samples were collected 24 February - 11 March 1999;

Summer samples were collected 8 - 27 July 1999; and,

Autumn samples were collected 8 - 19 September 1999.

NEWPCC - North End Water Pollution Control Centre
 SEWPCC - South End Water Pollution Control Centre
 WEWPCC - West End Water Pollution Control Centre
 - Study Area

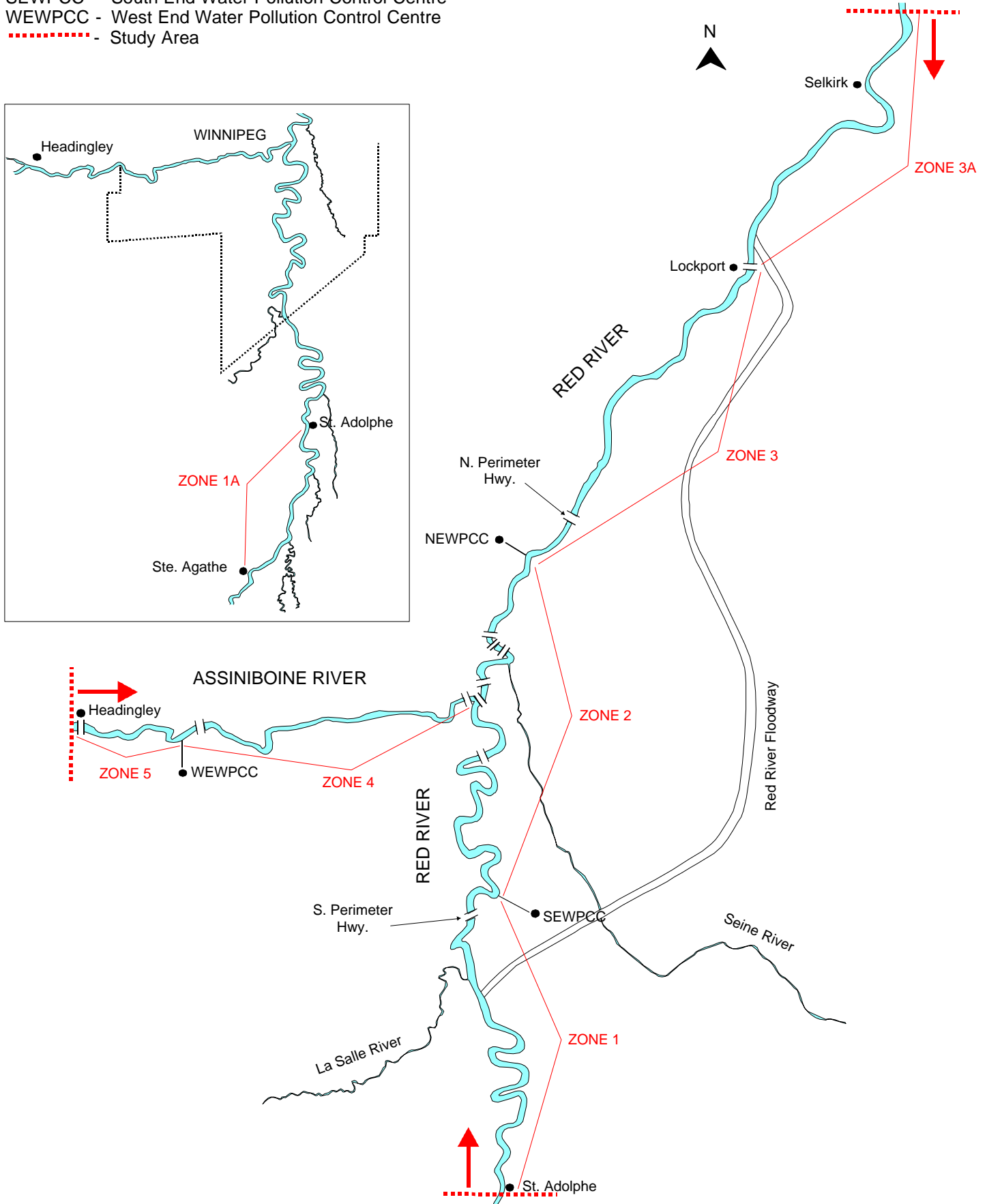

Figure 1. Study Area for the City of Winnipeg Ammonia Criteria Study.



Figure 2. Fish habitat survey segments on the Red River, south of the Forks, and on the Assiniboine River.

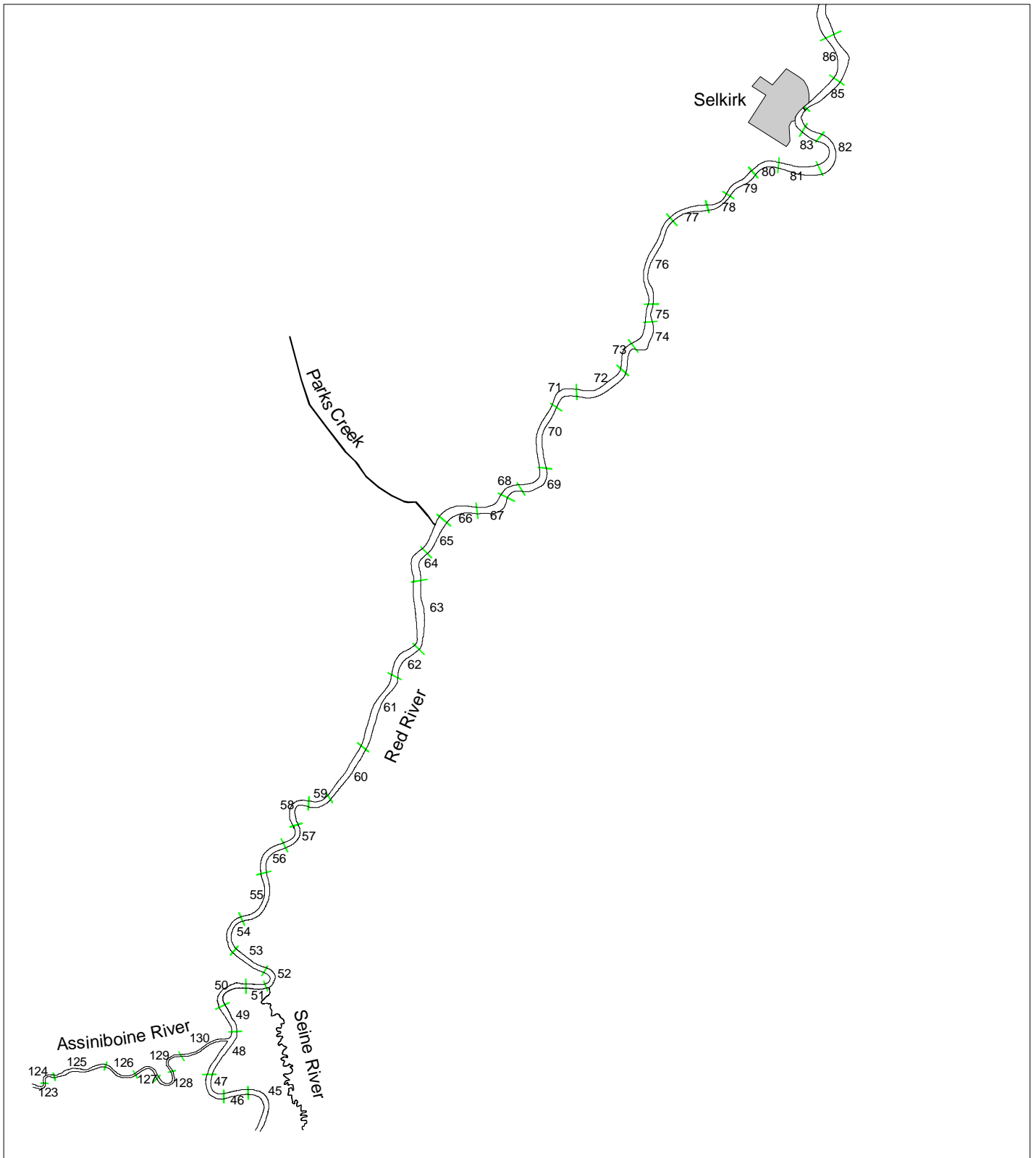

Figure 3. Fish habitat survey segments on the Red River north of the Forks.

3.1 RED RIVER (Segments 1 - 86)

RIVER: Red River
 ZONE: 1A

Location	UTM (14U) NAD 83		Date	Time	Total Depth		Conductivity (mS/cm)	Turbidity (NTU)	Dissolved Oxygen (mg/L)	Temperature (°C)	Total Ammonia Nitrogen (mg N/L)	Unionized Ammonia (mg NH ₃ /L)
	E	N			(m)	pH						
Hard Substrate												
Left bank	631162	5490320	27-Jul-99	10:00			0.595	355	5.21	25.3	0.00	n/a
			19-Sep-99	13:05	4.74	7.73	0.578	134	8.40	14.8	0.01	0.0002
Medium Substrate												
Left bank	635956	5499913	27-Jul-99	13:00			0.591	319	4.58	25.4	0.01	n/a
			19-Sep-99	12:20	5.53	7.74	0.573	134	8.63	14.7	0.05	0.0009
Soft Substrate												
Right bank	636522	5501288	27-Jul-99	14:10			0.591	366	4.32	25.5	0.01	n/a
			19-Sep-99	11:45		7.74	0.572	132	8.10	14.7	0.17	0.0030

n/a - data not available

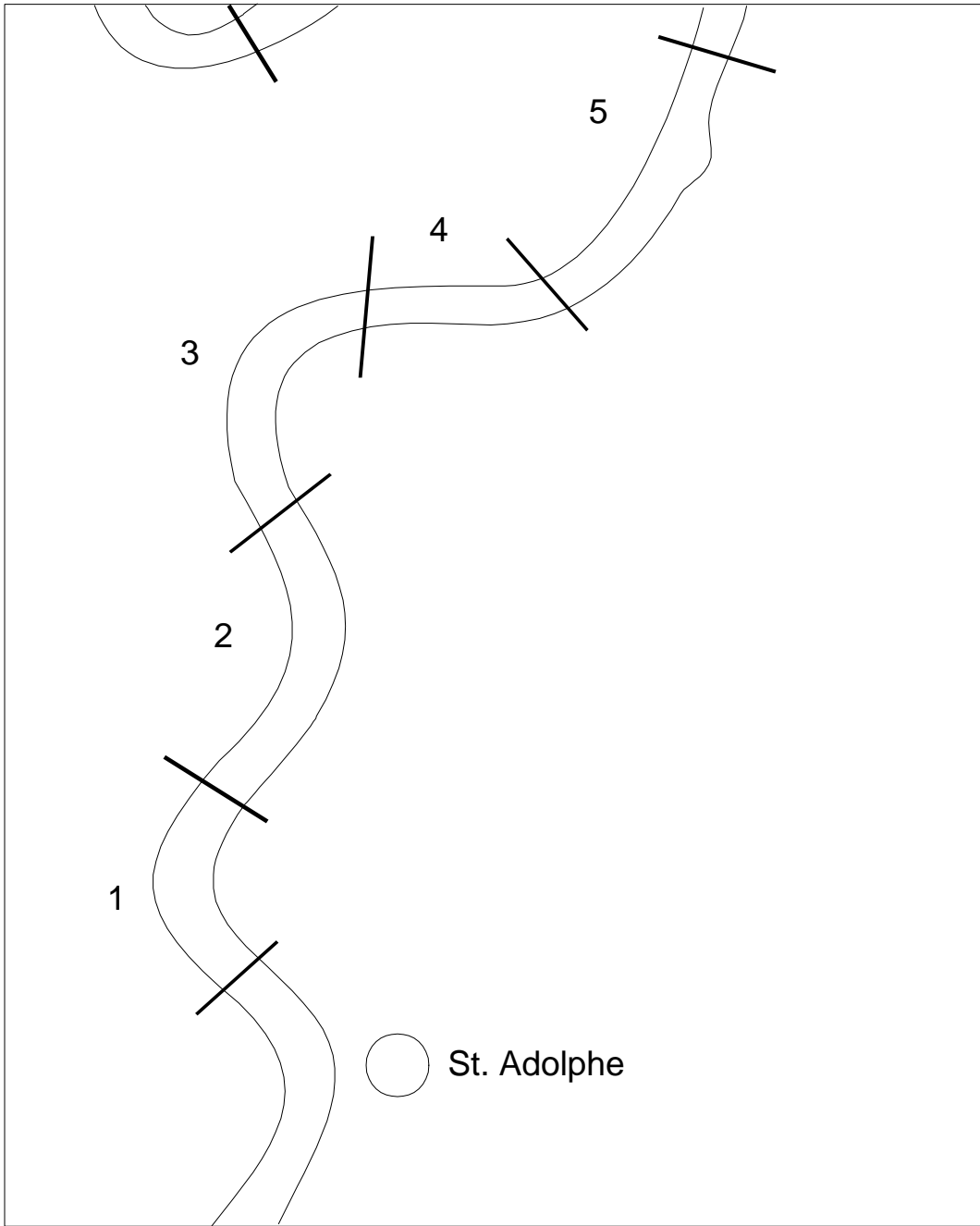

Figure 4. Red River segments 1 - 5.

RIVER: Red River
 ZONE: 1

Location	UTM (14U) NAD 83		Date	Time	Total Depth		Conductivity (mS/cm)	Turbidity (NTU)	Dissolved Oxygen (mg/L)	Temperature (°C)	Total Ammonia Nitrogen (mg N/L)	Unionized Ammonia (mg NH ₃ /L)
	E	N			(m)	pH						
Segment 4												
Left bank			4-Mar-99		2.30	7.55	0.701	11	12.23	0.2	0.09	0.0003
Near mid-channel	636525	5506277	4-Mar-99	9:55	8.10	7.51	0.695	12	12.24	0.4	0.09	0.0003
Segment 5												
Left bank	637041	5506817	9-Mar-99		2.30	8.37	0.732	13	11.88	0.1	0.11	0.0026
Mid-channel			9-Mar-99		3.30	8.25	0.730	13	11.50	0.1	0.11	0.0019

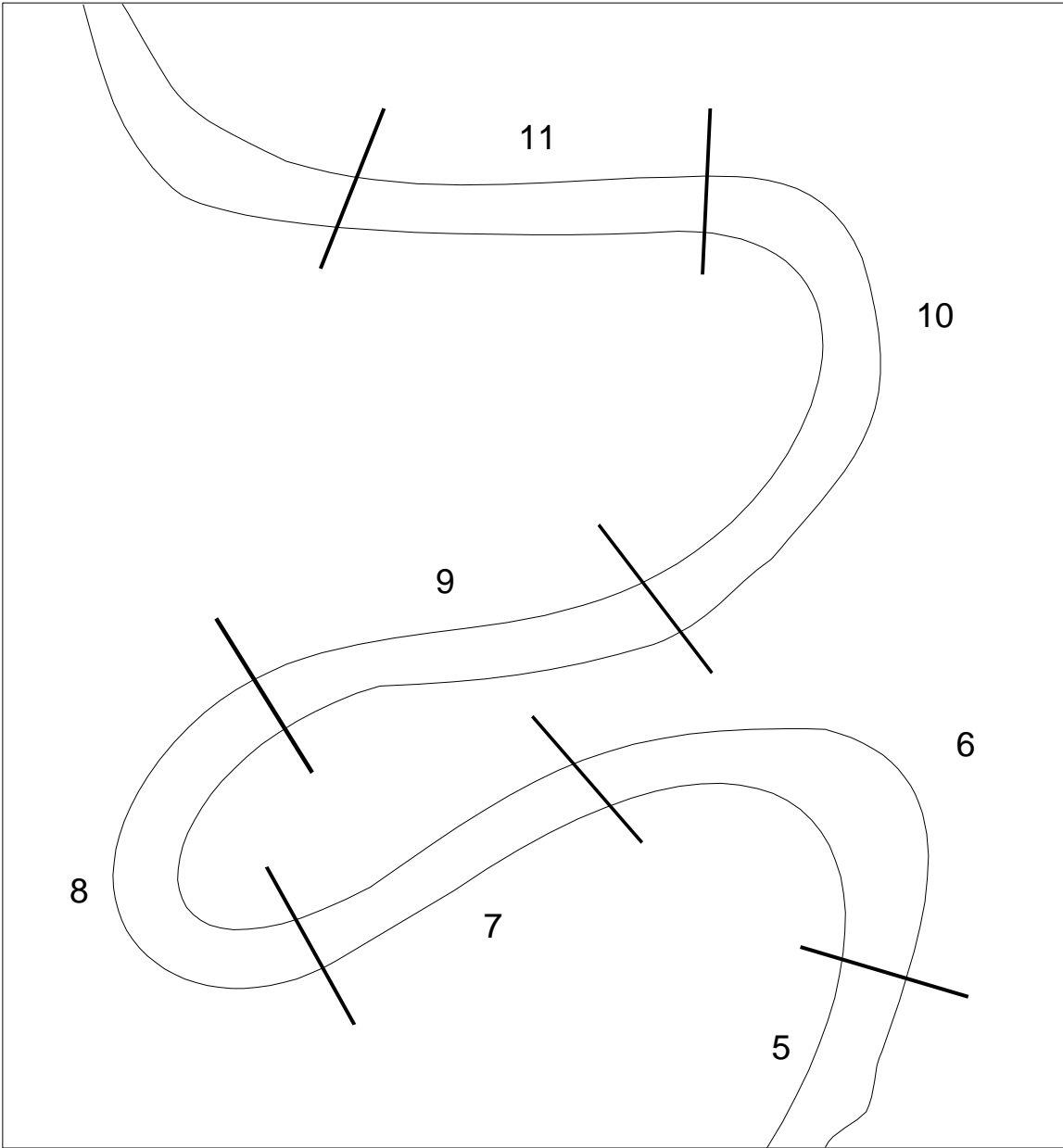

Figure 5. Red River segments 6 - 11.

RIVER: Red River
 ZONE: 1

Location	UTM (14U) NAD 83		Date	Time	Total Depth		Conductivity (mS/cm)	Turbidity (NTU)	Dissolved Oxygen (mg/L)	Temperature (°C)	Total Ammonia Nitrogen (mg N/L)	Unionized Ammonia (mg NH ₃ /L)
	E	N			(m)	pH						
Segment 6												
Left bank			4-Mar-99	14:03	2.70	7.71	0.702	10	11.85	0.1	0.10	0.0005
Near mid-channel	636996	5507548	4-Mar-99	13:50	5.90	7.74	0.692	11	12.07	0.3	0.11	0.0006
Segment 8												
Left bank			4-Mar-99		4.30	7.67	0.666	10	11.97	0.2	0.09	0.0004
Near mid-channel	635332	5507228	4-Mar-99	12:20	6.40	7.69	0.626	11	12.25	0.4	0.11	0.0006
Segment 10												
Near mid channel	636937	5508801	3-Mar-99	10:05	3.40	7.43	0.698	12	11.63	0.4	0.12	0.0003
Right bank			3-Mar-99	10:15	2.30	7.37	0.698	13	11.92	0.1	0.12	0.0003

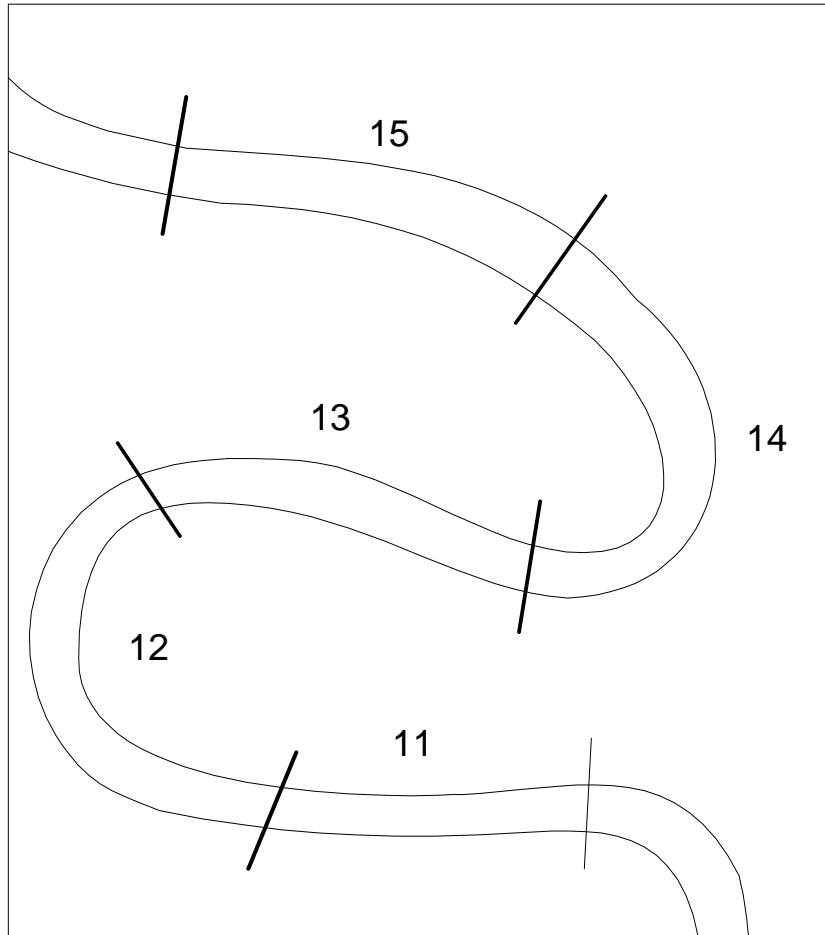

Figure 6. Red River segments 11 - 15.

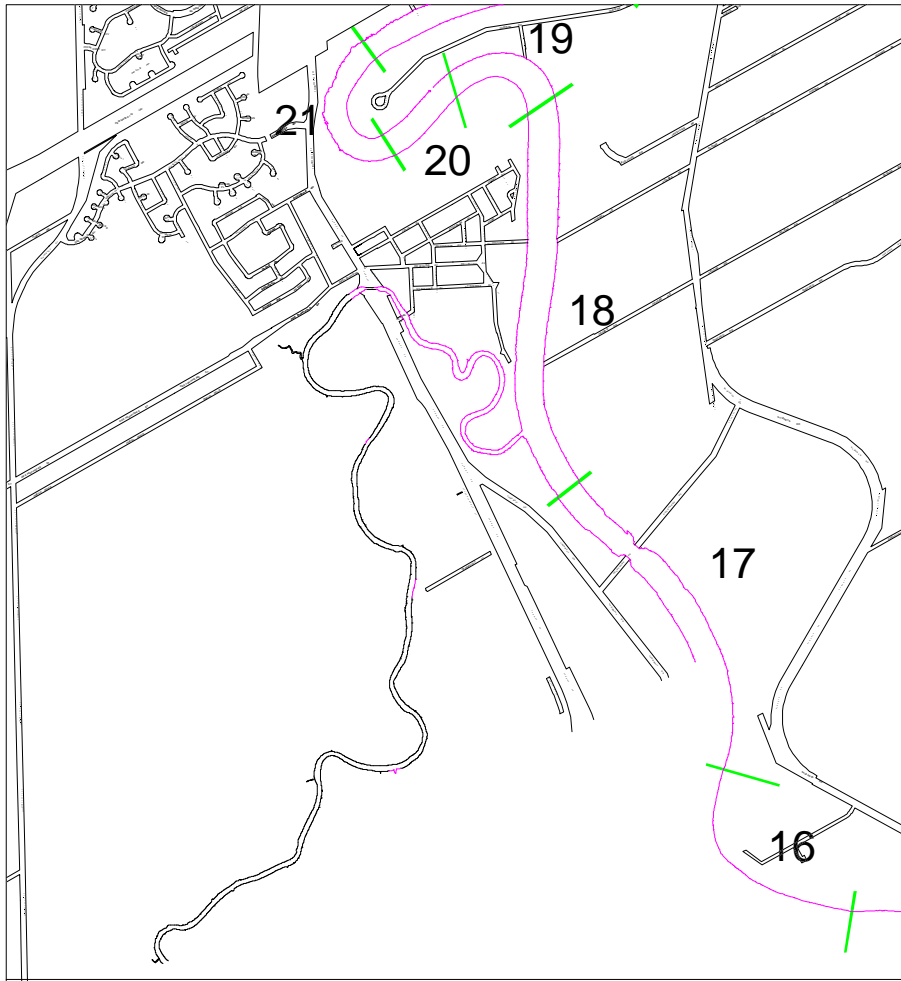

Figure 7. Red River segments 16-21.

RIVER: Red River
 ZONE: 1

Location	UTM (14U) NAD 83		Date	Time	Total Depth		Conductivity (mS/cm)	Turbidity (NTU)	Dissolved Oxygen (mg/L)	Temperature (°C)	Total Ammonia Nitrogen (mg N/L)	Unionized Ammonia (mg NH ₃ /L)
	E	N			(m)	pH						
Segment 16												
Left bank			3-Mar-99	11:29	3.00	7.62	0.719	11	11.87	0.2	0.11	0.0005
Near mid-channel	634859	5511040	3-Mar-99	11:17	2.50	7.63	0.712	11	12.01	0.4	0.11	0.0005
Segment 17												
Near mid-channel	634768	5512080	3-Mar-99		2.70	7.69	0.708	11	11.99	0.4	0.14	0.0007
Right bank			3-Mar-99	12:54	2.40	7.69	0.718	11	11.53	0.3	0.13	0.0007
Segment 18												
Mid-channel			9-Mar-99	10:30	3.40	8.13	0.719	12	12.07	0.2	0.12	0.0016
Right bank	633868	5513233	9-Mar-99	11:10	2.00	8.21	0.697	12	12.37	0.1	0.11	0.0018
			26-Jul-99	14:45			0.590	259	5.85	26.1	0.04	n/a
Left bank			18-Sep-99	10:30		7.67	0.542	150	7.95	15.1	0.01	0.0002
Segment 19												
Mid-channel			9-Mar-99	12:15	3.80	8.36	0.720	12	11.88	0.2	0.11	0.0025
Right bank	633823	5515122	9-Mar-99	12:30	1.70	8.39	0.753	12	11.75	0.1	0.11	0.0027
			26-Jul-99	14:15			0.593	448	5.89	26.1	0.07	n/a
Right bank			18-Sep-99	11:10		7.68	0.543	150	7.89	15.1	0.01	0.0002
Segment 21												
Left bank			1-Mar-99	11:00	2.40	7.71	0.722	11	11.66	0.2	0.10	0.0005
Right bank	633045	5574834	1-Mar-99	10:45	3.70	7.55	0.706		11.70	0.6	0.12	0.0004

n/a - data not available

RIVER: Red River
 ZONE: 1 (Tributary)

Location	UTM (14U) NAD 83		Date	Time	Total Depth (m)	pH	Conductivity (mS/cm)	Turbidity (NTU)	Dissolved Oxygen (mg/L)	Temperature (°C)	Total Ammonia Nitrogen (mg N/L)	Unionized Ammonia (mg NH ₃ /L)
	E	N										
LaSalle River (Segment 18)												
At 20 m upstream of confluence with Red River			26-Jul-99	10:00	2.00		0.632	177	6.43	25.7	0.04	n/a
At confluence with Red River			18-Sep-99	9:50	3.72	7.66	0.550	148	7.87	15.1	0.02	0.0003

n/a - data not available

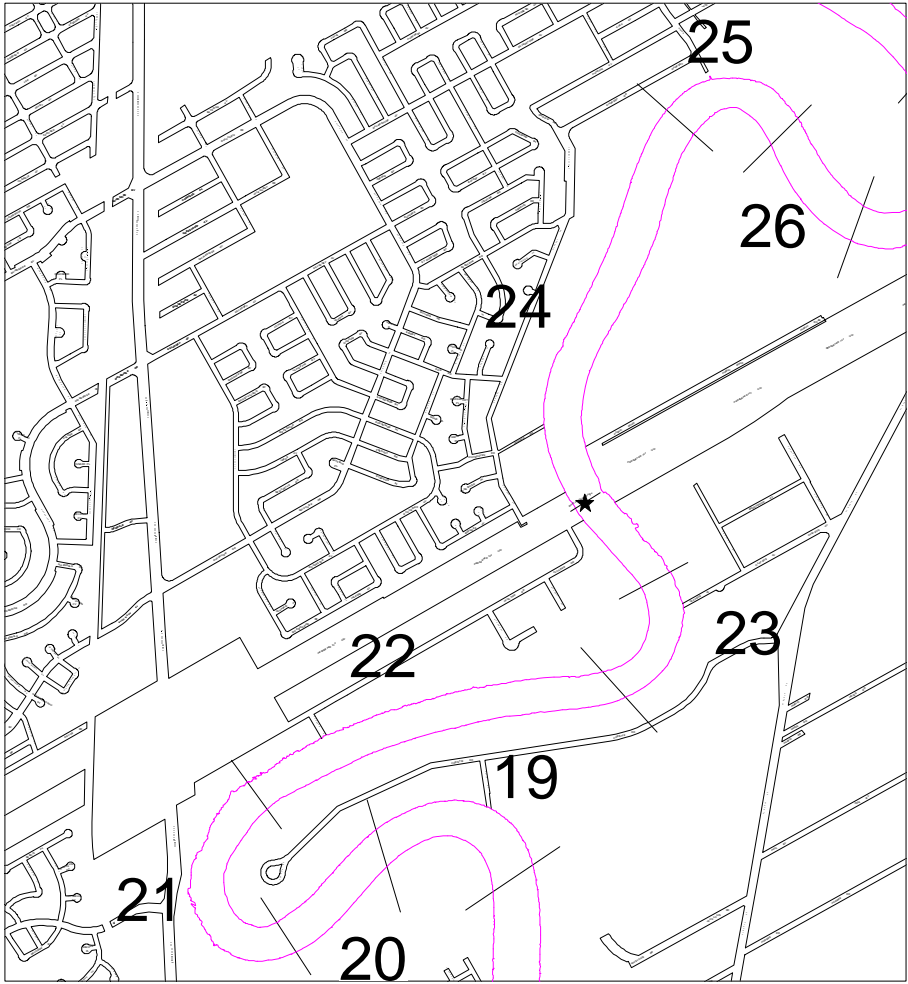

Figure 8. Red River segments 19-26.

RIVER: Red River
 ZONE: 1

Location	UTM (14U) NAD 83		Date	Time	Total Depth		Conductivity (mS/cm)	Turbidity (NTU)	Dissolved Oxygen (mg/L)	Temperature (°C)	Total Ammonia Nitrogen (mg N/L)	Unionized Ammonia (mg NH ₃ /L)
	E	N			(m)	pH						
Segment 23												
Left bank			26-Jul-99	13:15			0.592	213	5.87	26.2	0.01	n/a
			18-Sep-99	11:50	7.68		0.541	148	7.88	15.2	0.00	0.0000
Segment 25												
Left bank			1-Mar-99		4.60	7.64	0.721	11	11.60	0.3	0.12	0.0005
Right bank	634684	5517798	1-Mar-99	12:30	3.70	7.70	0.726	12	11.62	0.5	0.11	0.0006
Segment 26												
Left bank			1-Mar-99	14:00	2.40	7.52	0.730	12	11.51	0.3	0.11	0.0004
Right bank	634996	5517554	1-Mar-99		2.80	7.58	0.725	11	11.67	0.3	0.12	0.0005

n/a - data not available

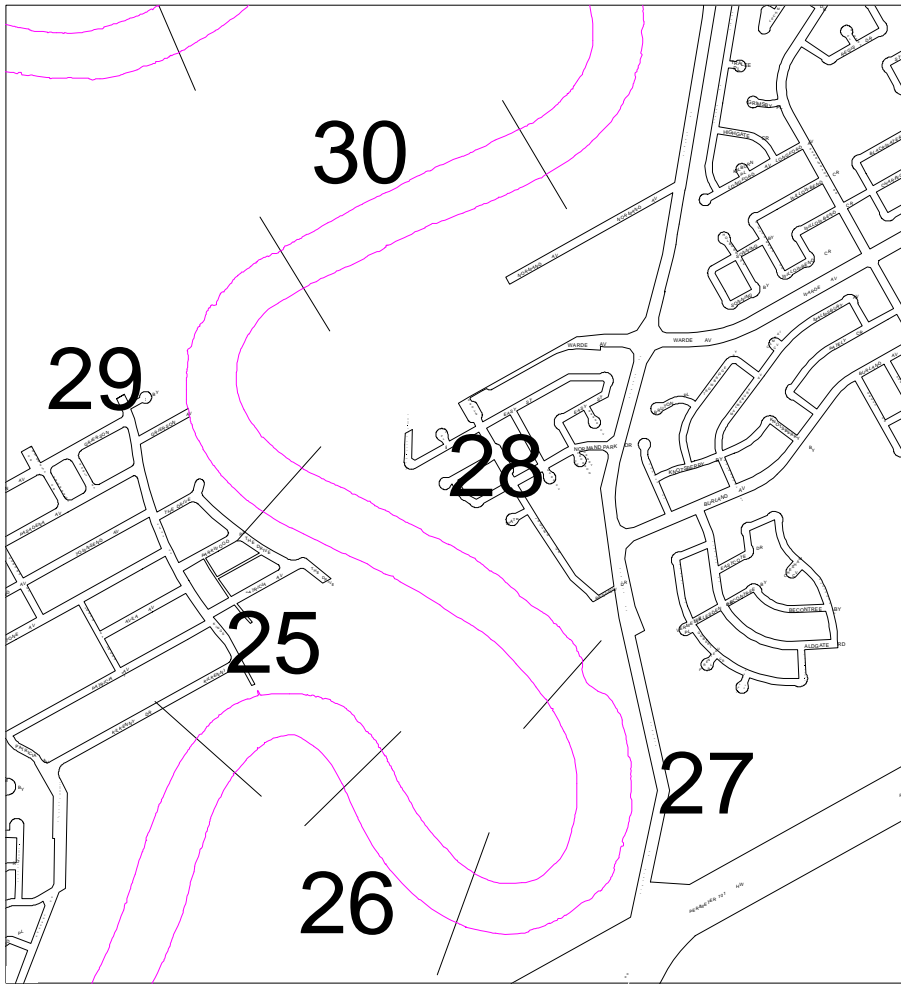

Figure 9. Red River segments 25-30.

RIVER: Red River
 ZONE: 2

Location	UTM (14U) NAD 83		Date	Time	Total Depth		Conductivity (mS/cm)	Turbidity (NTU)	Dissolved Oxygen (mg/L)	Temperature (°C)	Total Ammonia Nitrogen (mg N/L)	Unionized Ammonia (mg NH ₃ /L)
	E	N			(m)	pH						
SEWPCC outfall mixing zone (Segment 27)												
Left bank			26-Jul-99	12:15			0.594	259	7.60	26.1	0.07	n/a
Mid-channel			26-Jul-99	12:30			0.595	239	6.52	26.1	0.05	n/a
Right bank			26-Jul-99	12:46			0.594	145	6.30	26.3	0.00	n/a
10 m from Left bank			18-Sep-99	12:20	3.57	7.65	0.540	153	7.83	15.2	0.05	0.0007
Mid-channel			18-Sep-99	12:40	5.94	7.66	0.541	149	7.79	15.2	0.07	0.0011
5 m from Right bank			18-Sep-99	13:00	2.38	7.67	0.540	157	7.75	15.3	0.01	0.0002
Segment 29												
			9-Jul-99	13:30	6.90	7.62	0.598	237	7.11	21.9	0.00	0.0000
			12-Sep-99		5.25	7.91	0.475	604	7.43	15.4	0.42	0.0114

n/a - data not available

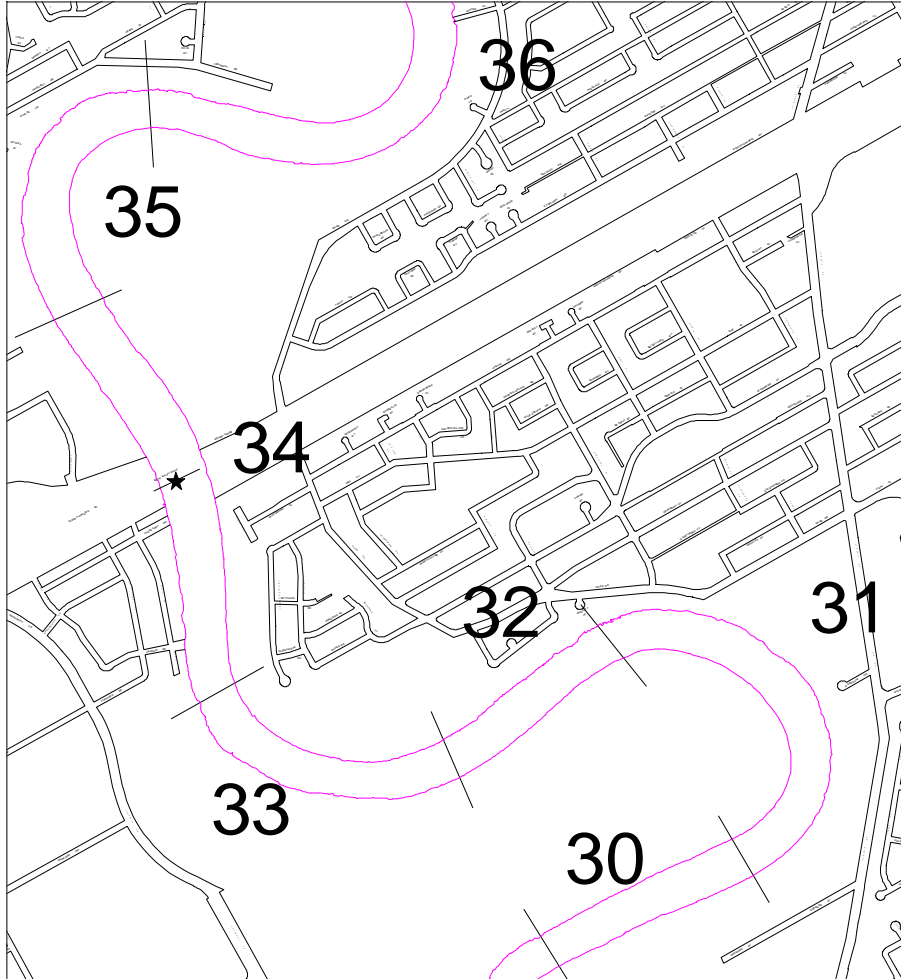

Figure 10. Red River segments 30-35.

RIVER: Red River
 ZONE: 2

Location	UTM (14U) NAD 83		Date	Time	Total Depth		Conductivity (mS/cm)	Turbidity (NTU)	Dissolved Oxygen (mg/L)	Temperature (°C)	Total Ammonia Nitrogen (mg N/L)	Unionized Ammonia (mg NH ₃ /L)
	E	N			(m)	pH						
Segment 33												
30 m from Left bank	634298	5519551	26-Feb-99	14:38	3.50	7.60	0.746	13	11.20	0.5	0.29	0.0012
Left bank			26-Feb-99	14:45	1.70	7.65	0.773	13	11.26	0.2	0.30	0.0014
Segment 34												
Left of mid-channel			26-Feb-99	13:35	2.00	7.62	0.722	10	11.46	0.2	0.27	0.0011
Right of mid-channel	633459	5520646	26-Feb-99	13:30	2.00	7.50	0.719	11	11.54	0.3	0.31	0.0010
			9-Jul-99	12:20	4.40	7.60	0.596	213	6.73	21.8	0.02	0.0004
			12-Sep-99		4.10	7.96	0.478	623	7.46	15.4	0.47	0.0143

RIVER: Red River
 ZONE: 2

Location	UTM (14U) NAD 83		Date	Time	Total Depth		Conductivity (mS/cm)	Turbidity (NTU)	Dissolved Oxygen (mg/L)	Temperature (°C)	Total Ammonia Nitrogen (mg N/L)	Unionized Ammonia (mg NH ₃ /L)
	E	N			(m)	pH						
Segment 37												
Left bank			24-Feb-99	16:14	2.52	7.60	0.716	12	11.61	0.1	0.24	0.0010
Right bank			24-Feb-99	16:03	2.85	7.47	0.722	12	11.56	0.1	0.24	0.0007
Segment 38												
Left bank			26-Feb-99	11:45	3.75	7.52	0.719	11	11.42	0.3	0.45	0.0015
Near mid-channel	634138	5522888	26-Feb-99		2.50	7.62	0.704	11	11.48	0.6	0.39	0.0017
			9-Jul-99	11:45	4.90	7.62	0.595	196	6.68	21.8	0.02	0.0004
			12-Sep-99		4.85	7.95	0.483	7	665.00	15.2	0.12	0.0035
Segment 40												
Mid-channel			7-Mar-99	13:55	5.30	8.16	0.717	10	11.82	0.1	0.27	0.0039
Right bank			7-Mar-99	13:40	1.60	8.11	0.710	9	11.84	0.3	0.32	0.0042

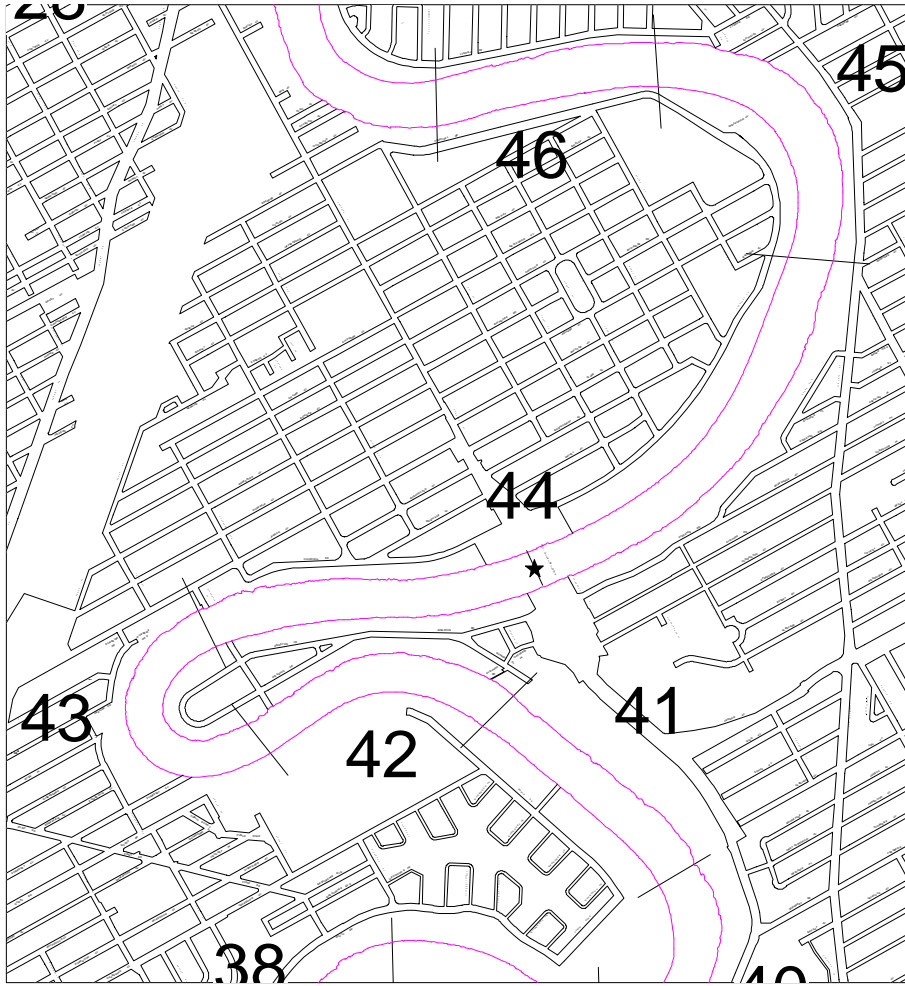

Figure 12. Red River segments 41-46.

RIVER: Red River
 ZONE: 2

Location	UTM (14U) NAD 83		Date	Time	Total Depth (m)	pH	Conductivity (mS/cm)	Turbidity (NTU)	Dissolved Oxygen (mg/L)	Temperature (°C)	Total Ammonia Nitrogen (mg N/L)	Unionized Ammonia (mg NH ₃ /L)
	E	N										
Segment 43												
Left bank			24-Feb-99	17:05	4.64	7.48	0.611	10	11.63	0.1	0.32	0.0010
Right bank	633528	5523360	24-Feb-99	16:54	4.30	7.48	0.713	10	11.72	0.2	0.34	0.0010
			9-Jul-99	10:35	2.40	7.77	0.596	196	6.45	21.7	0.03	0.0009
			13-Sep-99			7.94	0.461	488	7.39	15.2	0.11	0.0032
Segment 44												
Left bank			26-Feb-99		4.60	7.61	0.722	10	11.51	0.2	0.41	0.0017
Right bank	634112	5524124	26-Feb-99		2.30	7.74	0.710	10	11.84	0.6	0.38	0.0022

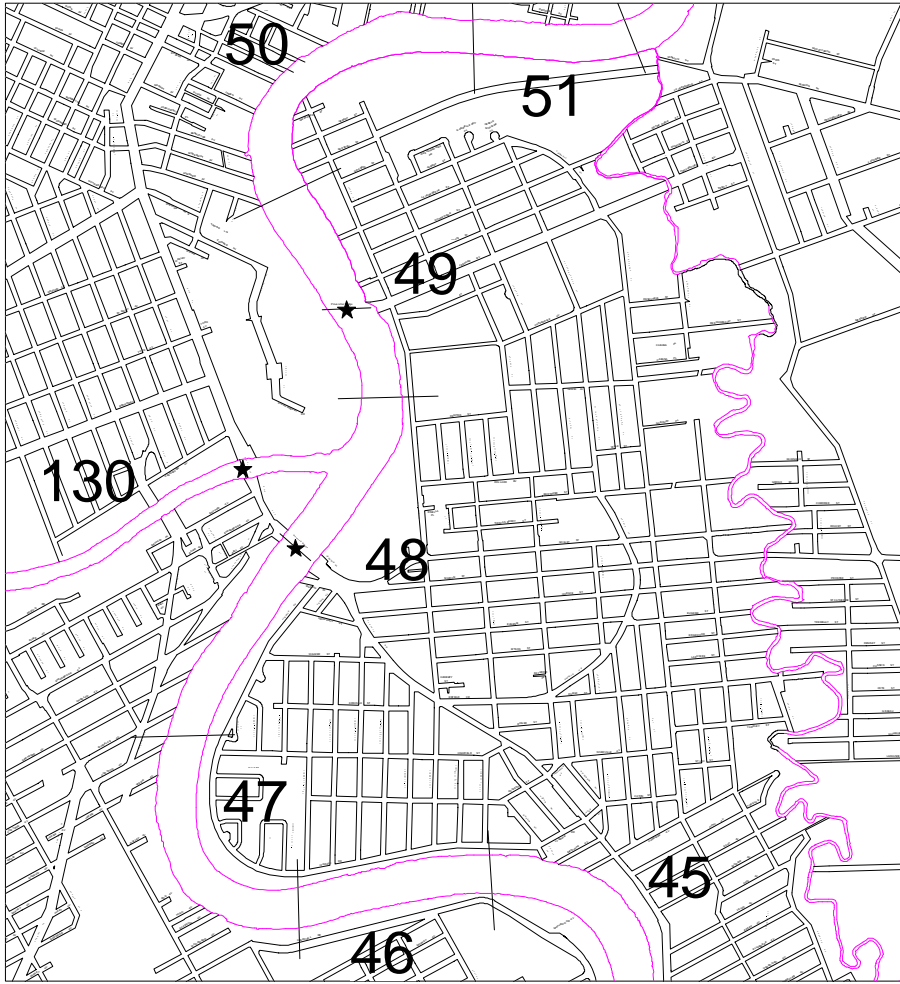

Figure 13. Red River segments 46-51.

RIVER: Red River
 ZONE: 2

Location	UTM (14U) NAD 83		Date	Time	Total Depth		Conductivity (mS/cm)	Turbidity (NTU)	Dissolved Oxygen (mg/L)	Temperature (°C)	Total Ammonia Nitrogen (mg N/L)	Unionized Ammonia (mg NH ₃ /L)
	E	N			(m)	pH						
Segment 50												
30 m from Right bank; Bottom measurements			25-Feb-99	10:45		7.25	0.920	12	12.28	0.1		
30 m from Right bank; Surface measurements			25-Feb-99	10:15	5.80	7.63	0.825	12	10.50	0.1	0.32	0.0014
40 m from Right bank; Bottom measurements			25-Feb-99			7.19	0.865	12	11.59	0.0		
40 m from Right bank; Surface measurements			25-Feb-99	10:55	4.10	7.62	0.812	11	11.03	0.0	0.32	0.0013
Near mid-channel; Bottom measurements			8-Jul-99	15:45	6.00	7.73	0.853	162	7.22	20.7	0.03	0.0008
Near mid-channel; Surface measurements			8-Jul-99	15:25	6.00	7.76	0.842	184	7.53	21.1	0.05	0.0015
Near shore			8-Jul-99	16:15	1.35	7.62	0.879	152	7.25	21.0	0.01	0.0002
			13-Sep-99			7.72	0.730	343	8.15	14.4	0.16	0.0026
Segment 51												
30 m from Right bank; Bottom measurements			25-Feb-99			7.20	0.860	12	11.77	0.4		
30 m from Right bank; Bottom measurements			25-Feb-99			7.20	0.864	12	11.74	0.2		
30 m from Right bank; Surface measurements			25-Feb-99	12:35	4.80	7.62	0.839	11	10.40	0.5	0.36	0.0016
30 m from Right bank; Surface measurements			25-Feb-99		5.00	7.61	0.858	12	10.60	0.2	0.37	0.0015

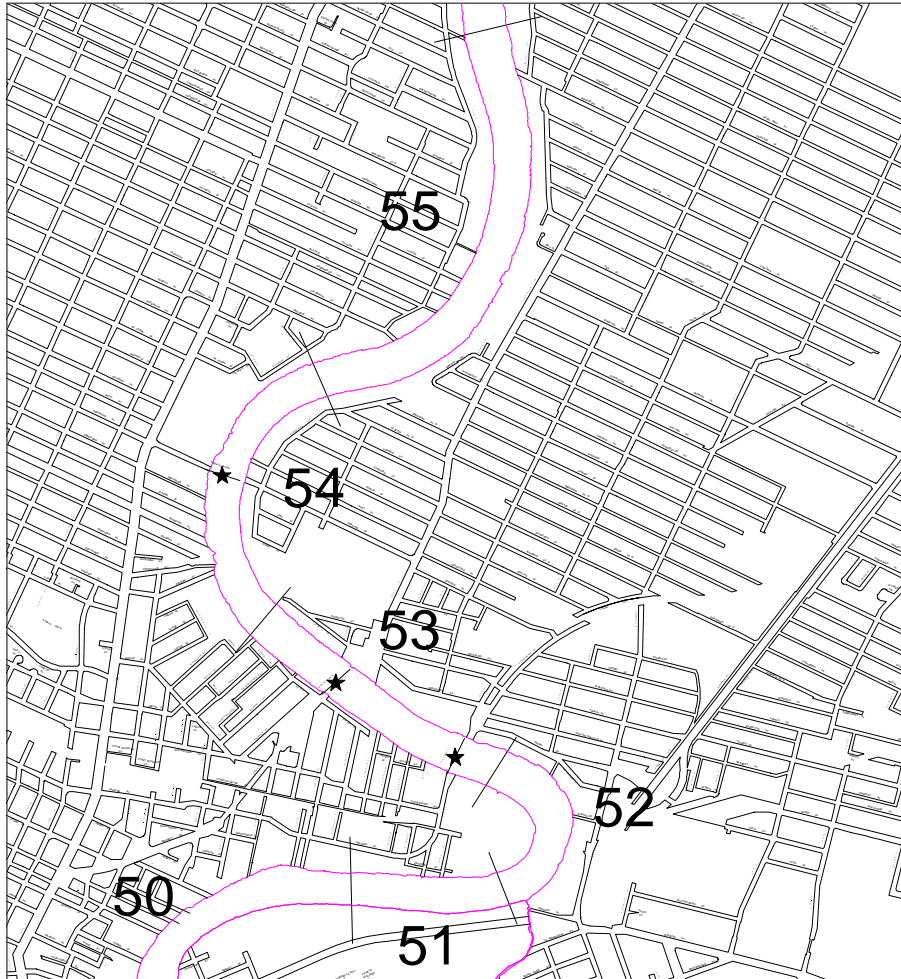

Figure 14. Red River segments 51-55.

RIVER: Red River
 ZONE: 2

Location	UTM (14U) NAD 83		Date	Time	Total Depth		Conductivity (mS/cm)	Turbidity (NTU)	Dissolved Oxygen (mg/L)	Temperature (°C)	Total Ammonia Nitrogen (mg N/L)	Unionized Ammonia (mg NH ₃ /L)
	E	N			(m)	pH						
Segment 52												
Mid-channel			7-Mar-99	10:50	6.40	8.10	0.804	10	11.20	0.3	0.27	0.0035
Right bank	635714	5529450	7-Mar-99	10:40	2.70	8.11	0.817		9.83	0.3	0.31	0.0041
Segment 55												
Left bank; Bottom measurements			25-Feb-99			7.37	0.845	12	10.87	0.1		
Left bank; Surface measurements			25-Feb-99		2.80	7.56	0.843	11	10.52	0.1	0.45	0.0016
Near mid-channel; Bottom measurements			25-Feb-99			7.16	0.844	11	11.75	0.3		
Near mid-channel; Surface measurements	636278	5532851	25-Feb-99	15:05	4.90	7.67	0.832	11	10.43	0.5	0.41	0.0020

RIVER: Red River
 ZONE: 2 (Tributary)

Location	UTM (14U) NAD 83		Date	Time	Total Depth (m)	pH	Conductivity (mS/cm)	Turbidity (NTU)	Dissolved Oxygen (mg/L)	Temperature (°C)	Total Ammonia Nitrogen (mg N/L)	Unionized Ammonia (mg NH ₃ /L)
	E	N										
Seine River (Segment 52)												
5 m upstream of confluence with Red River			22-Jul-99	13:40	1.80		0.677	48	6.07	27.2	0.04	n/a
At confluence with Red River			17-Sep-99	15:10	1.71	7.56	0.521	206	7.92	15.3	0.03	0.0004

n/a - data not available

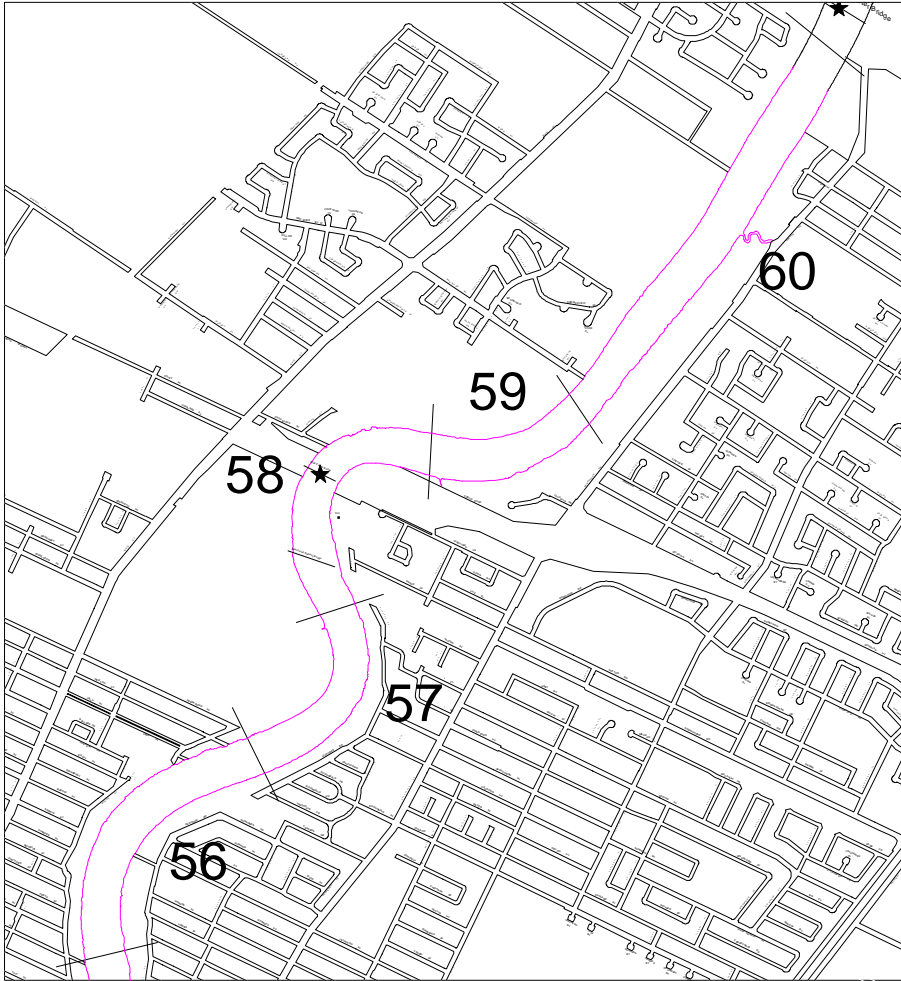

Figure 15. Red River segments 56-60.

RIVER: Red River
 ZONE: 2

Location	UTM (14U) NAD 83		Date	Time	Total Depth (m)	pH	Conductivity (mS/cm)	Turbidity (NTU)	Dissolved Oxygen (mg/L)	Temperature (°C)	Total Ammonia Nitrogen (mg N/L)	Unionized Ammonia (mg NH ₃ /L)
	E	N										
Segment 56												
Right bank; Bottom measurements			25-Feb-99			7.57	0.854	11	10.61	0.1	0.03	0.0001
Right bank; Surface measurements			25-Feb-99		2.20	7.60	0.849	11	10.65	0.2	0.44	0.0018
Near mid-channel; Bottom measurements			25-Feb-99			7.20	0.844	11	11.41	0.3		
Near mid-channel; Surface measurements	635786	5533574	25-Feb-99		3.80	7.58	0.841	12	10.58	0.4	0.47	0.0018
Near mid-channel; Bottom measurements			8-Jul-99	12:40	5.25	7.59	0.713	192	6.68	21.0	0.08	0.0016
Near mid-channel; Surface measurements			8-Jul-99	12:05	5.25	7.57	0.721	140	6.87	21.4	0.01	0.0002
5 m from shore			8-Jul-99	13:35	1.10	7.68	0.720	163	7.04	21.5	0.04	0.0010
			13-Sep-99			7.63	0.528	488	7.71	15.0	0.14	0.0020

RIVER: Red River
 ZONE: 3

Location	UTM (14U) NAD 83		Date	Time	Total Depth (m)	pH	Conductivity (mS/cm)	Turbidity (NTU)	Dissolved Oxygen (mg/L)	Temperature (°C)	Total Ammonia Nitrogen (mg N/L)	Unionized Ammonia (mg NH ₃ /L)
	E	N										
NEWPCC outfall mixing zone (Segment 58)												
300 m downstream of outfall - Left bank	636715	5534697	22-Jul-99	11:00	5.60		0.720	259	8.23	24.4	0.03	n/a
300 m downstream of outfall - Right bank	636611	5534789	22-Jul-99	12:27	4.70		0.725	236	6.90	24.5	0.34	n/a
700 m downstream of outfall - Left bank	637184	5534684	22-Jul-99	12:57	3.60		0.716	257	6.07	24.6	0.03	n/a
700 m downstream of outfall - Right bank	637107	5534764	22-Jul-99	12:15	5.40		0.723	259	7.05	24.5	0.17	n/a
1100 m downstream of outfall - Right bank	637613	5534942	22-Jul-99	12:07	6.00		0.727	271	7.77	24.5	0.24	n/a
300 m downstream of outfall, 7.5 m from Left bank			17-Sep-99	13:15	3.29	7.75	0.570	205	8.20	15.0	0.01	0.0002
300 m downstream of outfall, 15-20 m from Right bank			17-Sep-99	13:45	4.66	7.70	0.585	190	8.21	15.0	0.25	0.0041
700 m downstream of outfall, 7.5 m from Left bank			17-Sep-99	12:55	1.27	7.76	0.570	196	8.16	14.9	0.03	0.0006
700 m downstream of outfall, 15-20 m from Right bank			17-Sep-99	14:05	5.48	7.60	0.581	199	8.18	15.1	0.51	0.0067
1100 m downstream of outfall, 15-20 m from Right bank			17-Sep-99	14:30	7.51	7.66	0.578	202	8.47	15.1	0.38	0.0057
Segment 59												
			13-Jul-99	16:00	6.00	7.68	0.720	202	3.78	23.0	0.29	0.0081
			14-Sep-99		6.00	7.48	0.532	375	7.60	14.7	0.36	0.0035
Segment 60												
			12-Jul-99	13:25	3.70	7.65	0.715	185	5.80	22.6	0.00	0.0000
			14-Sep-99		2.85	7.57	0.527	387	7.62	14.7	0.09	0.0011

n/a - data not available

RIVER: Red River
 ZONE: 3 (Tributary)

Location	UTM (14U) NAD 83		Date	Time	Total Depth		pH	Conductivity (mS/cm)	Turbidity (NTU)	Dissolved Oxygen (mg/L)	Temperature (°C)	Total Ammonia Nitrogen (mg N/L)	Unionized Ammonia (mg NH ₃ /L)
	E	N			(m)								
Bunn's Creek (Segment 60)													
			22-Jul-99	10:10				0.812	190	6.50	24.4	0.14	n/a
			17-Sep-99	12:15	2.47	7.76		0.647	186	7.90	14.8	0.00	0.0000

n/a - data not available

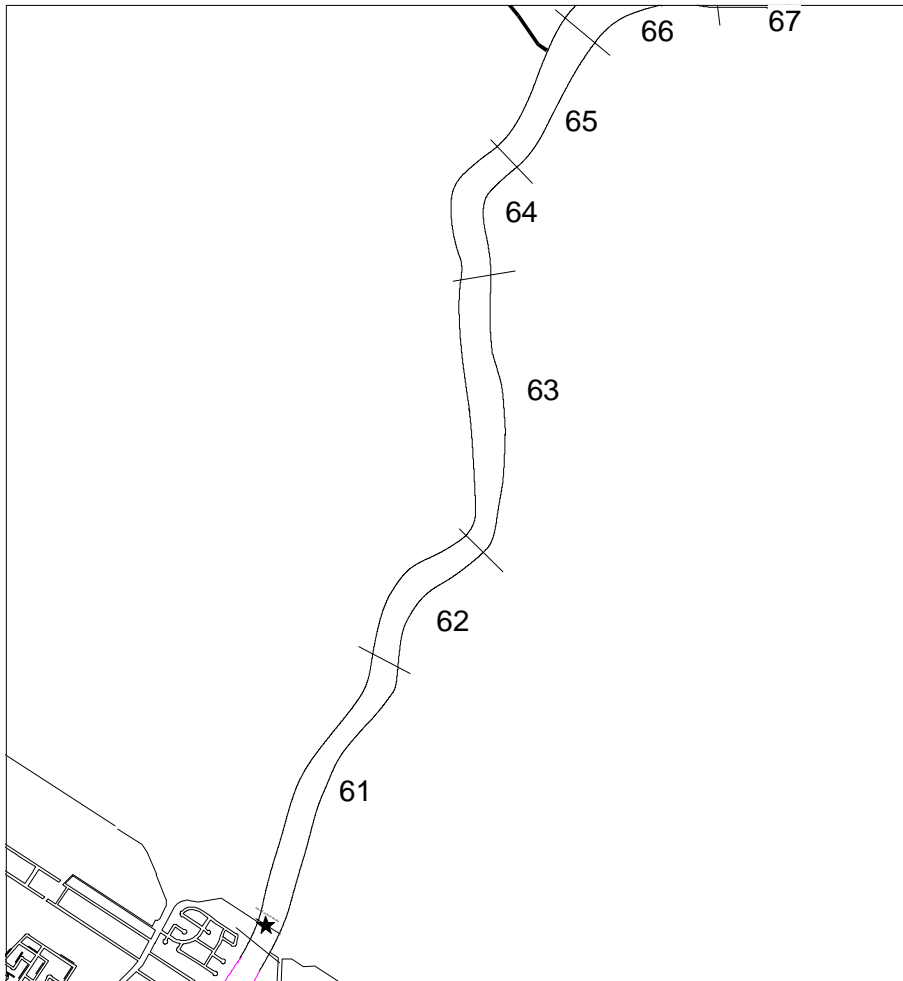

Figure 16. Red River segments 61-65.

RIVER: Red River
 ZONE: 3

Location	UTM (14U) NAD 83		Date	Time	Total Depth		Conductivity (mS/cm)	Turbidity (NTU)	Dissolved Oxygen (mg/L)	Temperature (°C)	Total Ammonia Nitrogen (mg N/L)	Unionized Ammonia (mg NH ₃ /L)
	E	N			(m)	pH						
Segment 61												
			12-Jul-99	12:00	3.20	6.75	0.716	190	5.76	22.7	0.00	0.0000
			14-Sep-99		4.55	7.61	0.526	377	7.65	14.7	0.06	0.0008
Segment 65												
			12-Jul-99	10:50	2.00	6.73	0.716	204	6.38	22.7	0.03	0.0001
			15-Sep-99	13:38		7.40	0.550	328	7.92	14.7	0.13	0.0011

RIVER: Red River
 ZONE: 3 (Tributary)

Location	UTM (14U) NAD 83		Date	Time	Total Depth		Conductivity (mS/cm)	Turbidity (NTU)	Dissolved Oxygen (mg/L)	Temperature (°C)	Total Ammonia Nitrogen (mg N/L)	Unionized Ammonia (mg NH ₃ /L)
	E	N			(m)	pH						
Park's Creek (Segment 65)												
20 m upstream of confluence with Red River			22-Jul-99	9:55			1.265	41	6.08	24.6		
			23-Jul-99	14:30			0.955	84	5.46	30.1	0.05	n/a
			17-Sep-99	11:30	0.61	7.95	0.689	194	8.50	15.0	0.13	0.0038

n/a - data not available

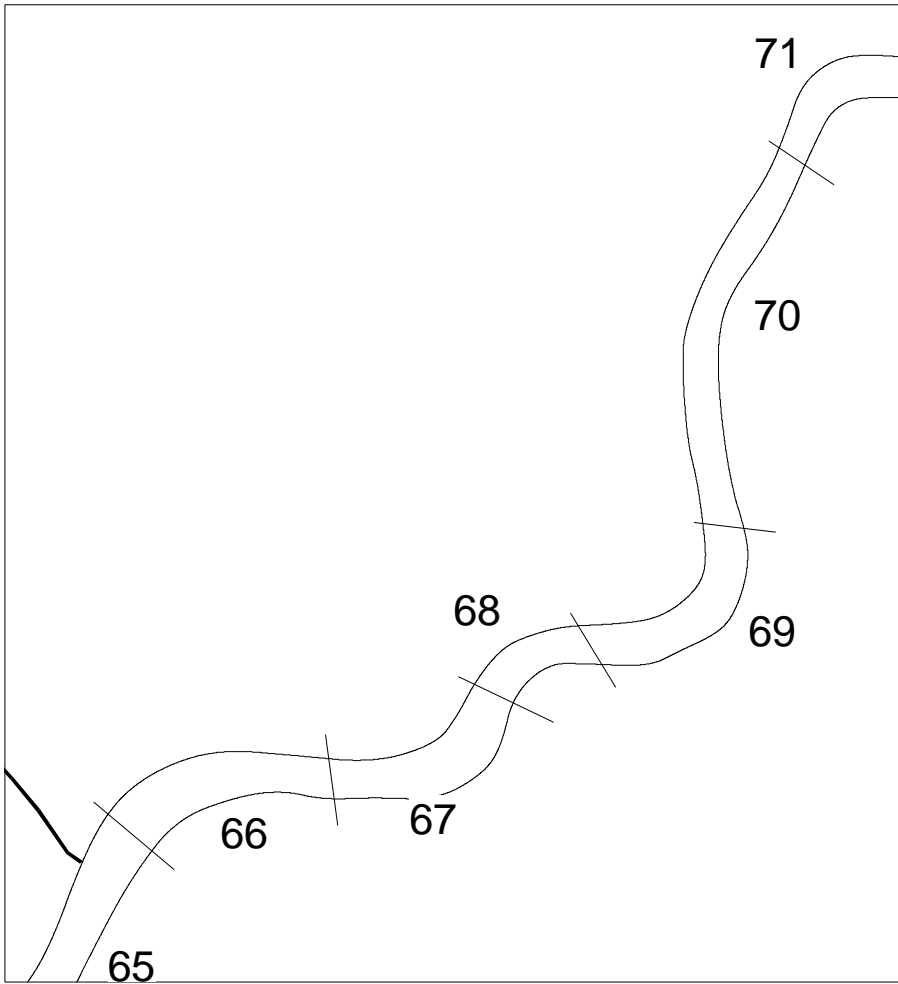

Figure 17. Red River segments 66-70.

RIVER: Red River
 ZONE: 3

Location	UTM (14U) NAD 83		Date	Time	Total Depth		Conductivity (mS/cm)	Turbidity (NTU)	Dissolved Oxygen (mg/L)	Temperature (°C)	Total Ammonia Nitrogen (mg N/L)	Unionized Ammonia (mg NH ₃ /L)
	E	N			(m)	pH						
Segment 68												
Left of mid-channel			27-Feb-99	11:15		7.57	0.946	15	9.88	0.6	2.16	0.0084
Right of mid-channel	643319	5544821	27-Feb-99		2.50	7.61	1.010	14	10.08	0.4	2.32	0.0098

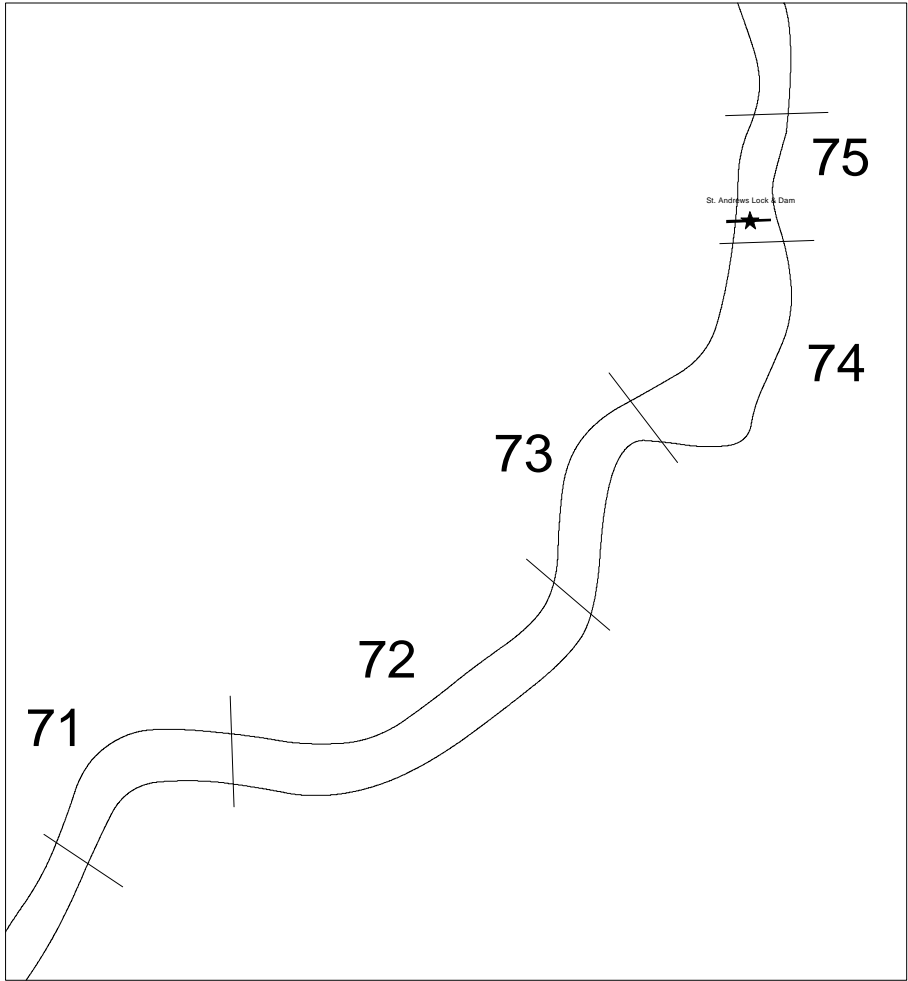

Figure 18. Red River segments 71-75.

RIVER: Red River
 ZONE: 3

Location	UTM (14U) NAD 83		Date	Time	Total Depth		Conductivity (mS/cm)	Turbidity (NTU)	Dissolved Oxygen (mg/L)	Temperature (°C)	Total Ammonia Nitrogen (mg N/L)	Unionized Ammonia (mg NH ₃ /L)
	E	N			(m)	pH						
Segment 71												
Right bank			27-Feb-99	12:55	2.70	7.45	1.010	14	10.28	0.1	2.35	0.0067
Right bank; Bottom measurements			27-Feb-99		2.70				10.22			
Right of mid-channel	645298	5547736	27-Feb-99		2.30	7.50	0.765	15	9.77	0.2	2.25	0.0072
Segment 72												
Mid-channel			8-Mar-99	10:50	3.20	8.23	0.813	11	10.64	0.2	1.44	0.0246
Right bank	646536	5548445	8-Mar-99	10:30	2.00	8.16	0.816	10	10.89	0.2	1.08	0.0157
			13-Jul-99	12:20	3.00		0.719	229	5.79	23.0	0.08	n/a
			15-Sep-99	11:51		7.16	0.547	335	7.87	14.7	0.14	0.0007
Segment 74												
Mid-channel			8-Mar-99	11:50	4.60	8.23	0.814	8	11.56	0.1	1.32	0.0223
Right bank	647471	5549740	8-Mar-99	11:35	2.90	8.28	0.820	8	11.35	0.1	1.00	0.0190
			13-Jul-99	11:35	3.90	6.78	0.716	221	5.79	22.9	0.04	0.0001
20 m from Left bank			15-Sep-99	10:45	1.80	7.14	0.541	396	7.88	14.4	0.12	0.0005

n/a - data not available

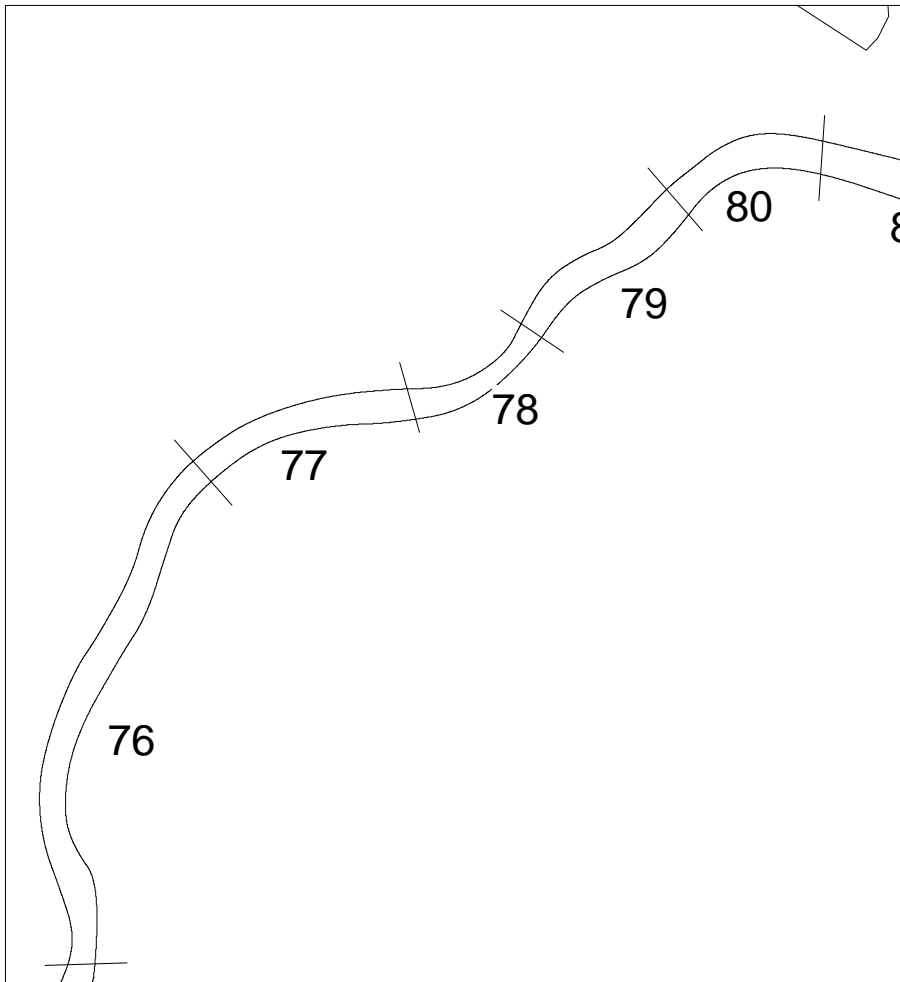

Figure 19. Red River segments 76-80.

RIVER: Red River
 ZONE: 3A

Location	UTM (14U) NAD 83		Date	Time	Total Depth		Conductivity (mS/cm)	Turbidity (NTU)	Dissolved Oxygen (mg/L)	Temperature (°C)	Total Ammonia Nitrogen (mg N/L)	Unionized Ammonia (mg NH ₃ /L)
	E	N			(m)	pH						
Segment 76												
Left bank			2-Mar-99	13:10	3.60	7.57	0.867	10	12.13	0.1	1.00	0.0037
Near mid-channel	647728	5552346	2-Mar-99	12:45	4.00	7.54	0.833	11	12.73	0.3	0.77	0.0027
Mid-channel	647624	5552338	11-Mar-99		3.50						1.36	n/a
Right Bank			11-Mar-99		1.30						1.10	n/a
15 m from Left bank			23-Jul-99	9:50	3.50		0.721	260	6.45	25.2	0.11	n/a
			16-Sep-99		1.83	7.64	0.561	315	9.34	14.9	0.02	0.0003
Segment 79												
Near mid-channel	650224	5554352	2-Mar-99	16:55	5.70	7.70	0.850	11	12.60	0.1	0.96	0.0048
Right bank			2-Mar-99	17:25	3.40	7.75	0.823	11	12.61	0.0	0.96	0.0054

n/a - data not available

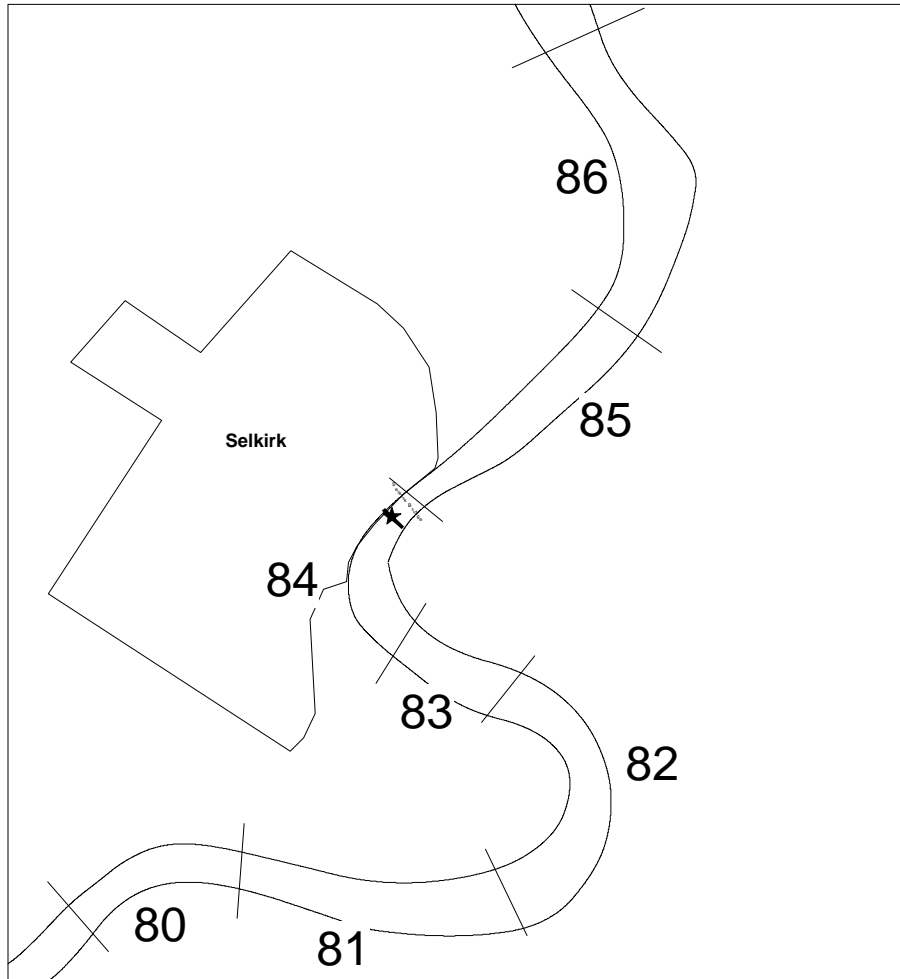

Figure 20. Red River segments 80-86.

RIVER: Red River
 ZONE: 3A

Location	UTM (14U) NAD 83		Date	Time	Total Depth		Conductivity (mS/cm)	Turbidity (NTU)	Dissolved Oxygen (mg/L)	Temperature (°C)	Total Ammonia Nitrogen (mg N/L)	Unionized Ammonia (mg NH ₃ /L)
	E	N			(m)	pH						
Segment 82												
Mid-channel	653137	5555167	11-Mar-99		4.60						0.78	n/a
Right bank			11-Mar-99		3.30						0.78	n/a
Segment 83												
Near mid-channel			2-Mar-99	15:20	5.90	7.55	0.847	12	12.25	0.1	1.00	0.0036
Right bank	652665	5555781	2-Mar-99	15:00	5.00	7.65	0.865	12	12.33	0.2	1.06	0.0048
25 m from Right bank			23-Jul-99	9:27			0.721	258	6.65	24.9	0.11	n/a
			16-Sep-99		2.62	7.65	0.555	351	9.77	14.6	0.11	0.0016
Segment 86												
Mid-channel	653429	5558004	11-Mar-99		4.30						1.14	n/a
Right bank			11-Mar-99		1.50						1.14	n/a
20 m from Right bank			23-Jul-99	12:45	2.00		0.719	179	5.90	25.3	0.12	n/a
			16-Sep-99	10:35	1.72	7.56	0.541	353	9.61	14.6	0.27	0.0031

n/a - data not available

3.2 ASSINIBOINE RIVER (Segments 101 - 130)

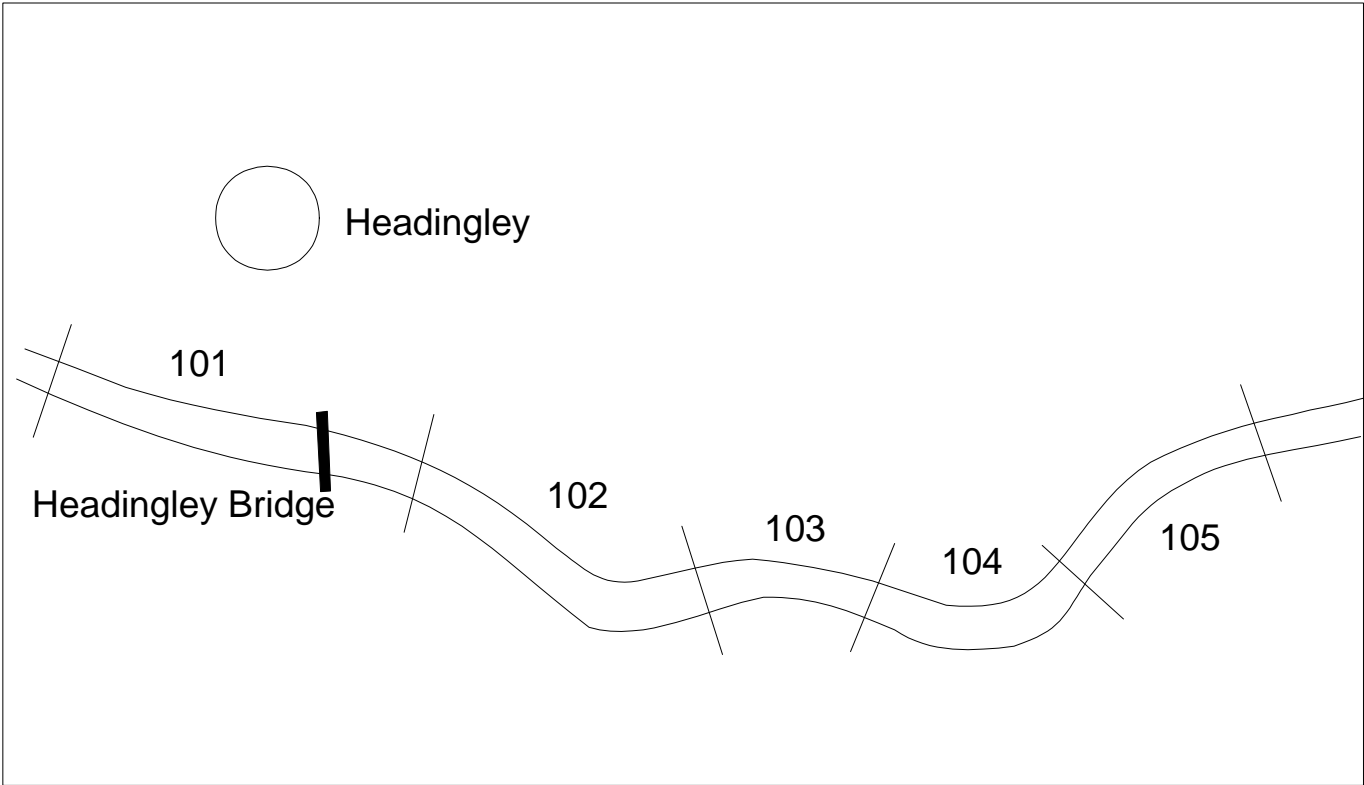

Figure 21. Assiniboine River segments 101 - 105.

RIVER: Assiniboine River
 ZONE: 5

Location	UTM (14U) NAD 83		Date	Time	Total Depth		Conductivity (mS/cm)	Turbidity (NTU)	Dissolved Oxygen (mg/L)	Temperature (°C)	Total Ammonia Nitrogen (mg N/L)	Unionized Ammonia (mg NH ₃ /L)
	E	N			(m)	pH						
Segment 101												
Left bank			5-Mar-99	12:10	1.50	7.81	1.210	12	7.79	0.2	0.03	0.0002
Right bank			5-Mar-99	11:55	1.30	7.79	1.200	12	8.30	0.4	0.03	0.0002
Segment 102												
			16-Jul-99	11:50	2.60	7.86	0.948	124	7.95	22.2		0.0000
			19-Jul-99	14:20							0.01	n/a
			8-Sep-99	9:40	1.60	8.75	1.020	78	8.96	16.9	0.00	0.0000
Segment 104												
Left bank			5-Mar-99	11:36	1.30	7.82	1.210	12	8.29	0.2	0.06	0.0004
Right bank	616588	5524749	5-Mar-99	11:20	1.40	7.79	1.210	12	8.45	0.2	0.06	0.0004
			16-Jul-99	12:10		7.56	0.950	112	7.63	22.2		0.0000
			19-Jul-99	14:10							0.05	n/a
			8-Sep-99	10:05	1.40	8.75	1.030	87	9.08	16.8	0.00	0.0000

n/a - data not available

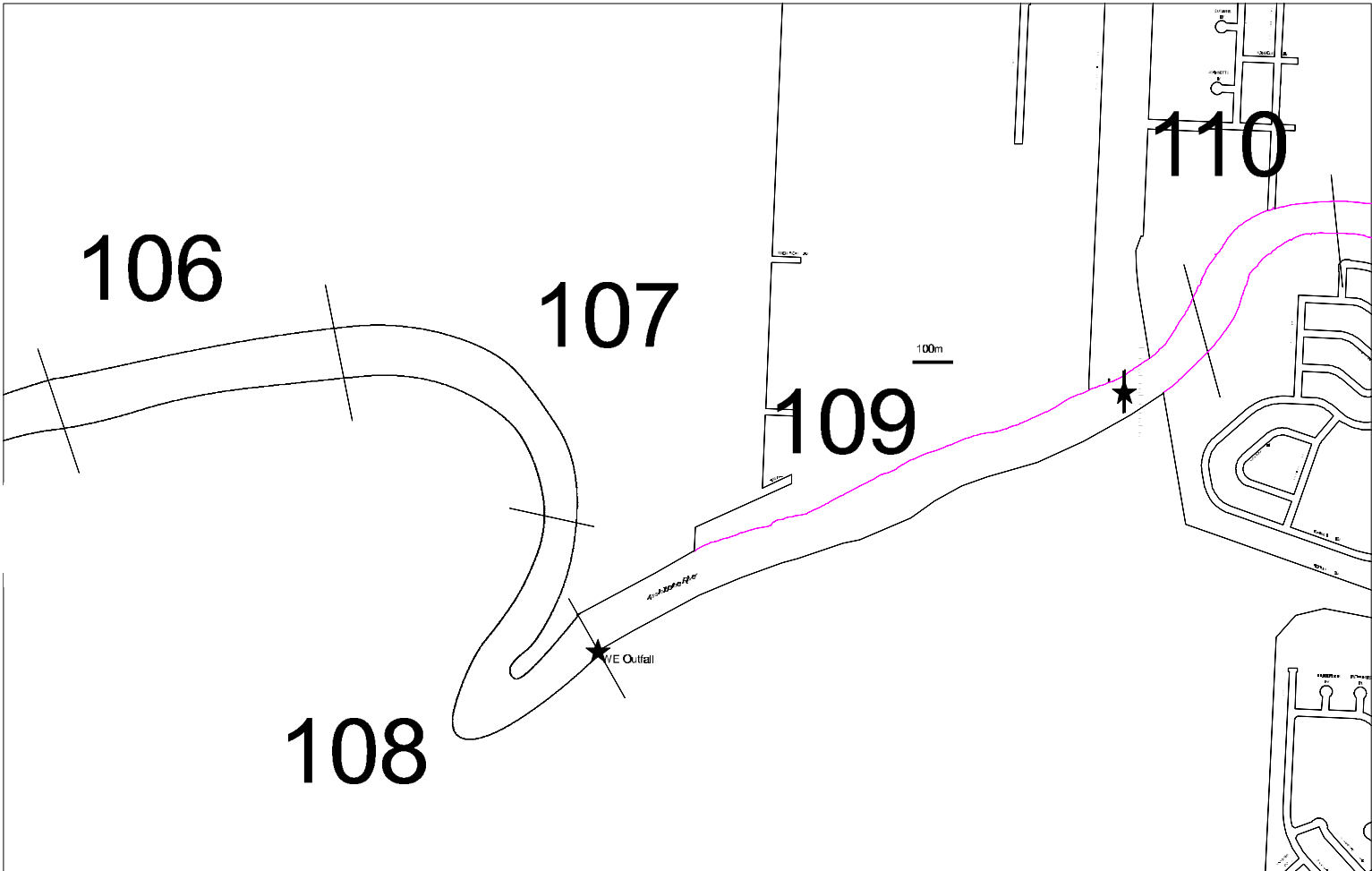

Figure 22. Assiniboine River segments 106-110.

RIVER: Assiniboine River
 ZONE: 5

Location	UTM (14U) NAD 83		Date	Time	Total Depth		Conductivity (mS/cm)	Turbidity (NTU)	Dissolved Oxygen (mg/L)	Temperature (°C)	Total Ammonia Nitrogen (mg N/L)	Unionized Ammonia (mg NH ₃ /L)
	E	N			(m)	pH						
Segment 108												
Left bank			5-Mar-99	10:35	0.70	7.87	1.210	12	8.11	0.3	0.03	0.0002
Right bank	618606	5524627	5-Mar-99	10:15	1.10	7.92	1.130	13	8.24	1.1	0.06	0.0005

RIVER: Assiniboine River
 ZONE: 4

Location	UTM (14U) NAD 83		Date	Time	Total Depth (m)	pH	Conductivity (mS/cm)	Turbidity (NTU)	Dissolved Oxygen (mg/L)	Temperature (°C)	Total Ammonia Nitrogen (mg N/L)	Unionized Ammonia (mg NH ₃ /L)
	E	N										
WEWPCC outfall mixing zone (Segment 108/109)												
100 m downstream of outfall - Left bank	619150	5524645	16-Jul-99	14:15	1.80	7.05	0.947	129	6.54	22.2		
100 m downstream of outfall - Right bank	619093	5524650	16-Jul-99	15:20	2.00	7.74	0.946	162	6.54	22.3		
300 m downstream of outfall	619500	5524728	16-Jul-99	14:35	1.00	7.25	0.948	138	6.42	22.2		
500 m downstream of outfall - Left Bank	619701	5524843	16-Jul-99	14:50	1.80	7.78	0.950	147	6.69	22.2		
500 m downstream of outfall - Right bank	619709	5524973	16-Jul-99	15:35	2.00	7.63	0.946	156	6.13	22.3	0.02	0.0005
900 m downstream of outfall - Left Bank	620180	5525194	16-Jul-99	15:50	1.40	7.75	0.948	150	6.66	22.3		
100 m downstream of outfall - Left bank			19-Jul-99	13:45							0.21	n/a
100 m downstream of outfall - Right bank			19-Jul-99	13:55							0.07	n/a
500 m downstream of outfall - Left Bank			19-Jul-99	13:35							0.20	n/a
900 m downstream of outfall - Left Bank			19-Jul-99	13:28							0.17	n/a
100 m downstream of outfall, Left bank			8-Sep-99	10:35	0.50	8.73	1.040	98	8.94	16.8	0.27	0.0472
100 m downstream of outfall, Right bank			8-Sep-99	10:45	1.15	8.75	1.030	93	9.51	16.8	0.04	0.0073
500 m downstream of outfall, Left bank			8-Sep-99	11:15	1.00	8.73	1.030	97	9.22	16.8	0.33	0.0577
500 m downstream of outfall, Right bank			8-Sep-99	11:00	1.55	8.76	1.020	93	9.48	16.9	0.01	0.0019
900 m downstream of outfall, Left bank			8-Sep-99	11:25	1.00	8.76	1.030	99	9.36	16.9	0.20	0.0373

n/a - data not available

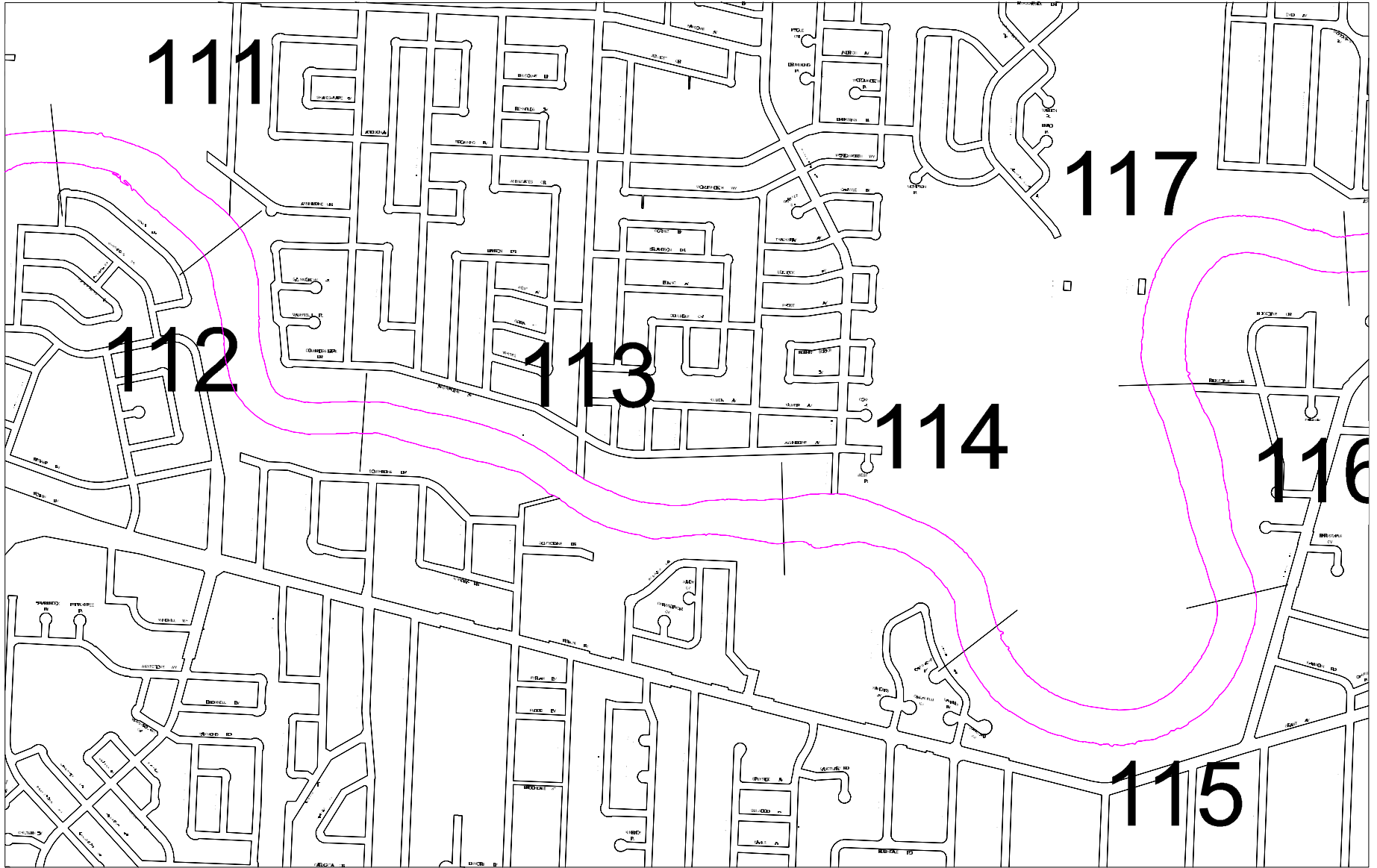

Figure 23. Assiniboine River segments 111-117.

RIVER: Assiniboine River
 ZONE: 4

Location	UTM (14U) NAD 83		Date	Time	Total Depth		Conductivity (mS/cm)	Turbidity (NTU)	Dissolved Oxygen (mg/L)	Temperature (°C)	Total Ammonia Nitrogen (mg N/L)	Unionized Ammonia (mg NH ₃ /L)
	E	N			(m)	pH						
Segment 113												
			14-Jul-99	11:30	1.75	7.59	0.950	132	5.80	22.9	0.13	0.0030
			8-Sep-99	11:50	1.00	8.73	1.030	95	9.48	16.9	0.11	0.0194
Segment 115												
Left bank (Hole 1)	623461	5524365	6-Mar-99	9:30	1.75	7.86	1.200	13	8.31	0.3	0.26	0.0019
Left bank (Hole 2)			6-Mar-99	10:00		7.92	0.940	13	8.47	0.1	0.77	0.0064
Right bank			6-Mar-99	10:15	1.60	7.80	1.210	13	8.39	0.1	0.09	0.0006

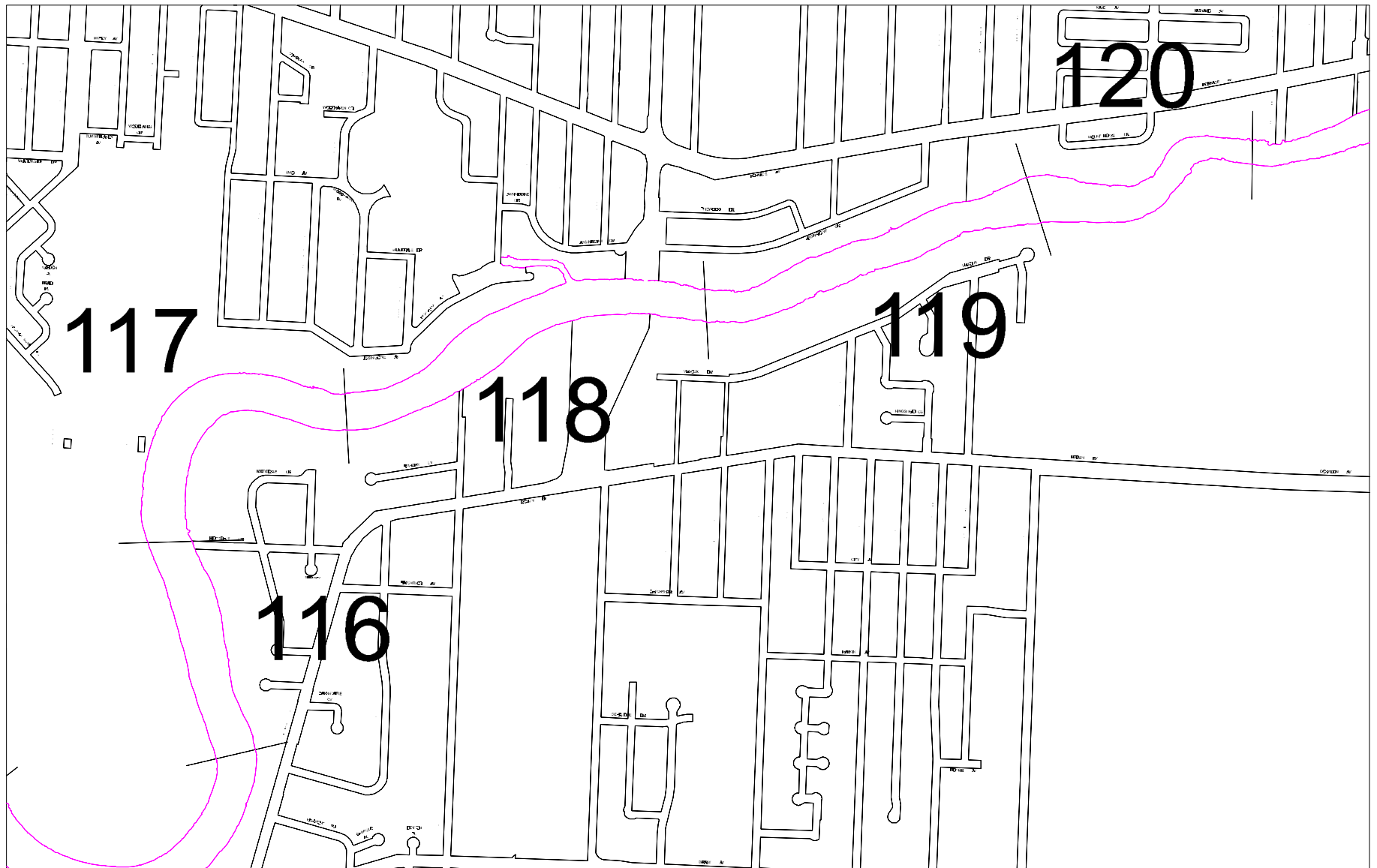

Figure 24. Assiniboine River segments 116-120.

RIVER: Assiniboine River
 ZONE: 4

Location	UTM (14U) NAD 83		Date	Time	Total Depth (m)	pH	Conductivity (mS/cm)	Turbidity (NTU)	Dissolved Oxygen (mg/L)	Temperature (°C)	Total Ammonia Nitrogen (mg N/L)	Unionized Ammonia (mg NH ₃ /L)
	E	N										
Segment 118 10 m upstream of confluence with Sturgeon Creek			19-Jul-99	13:10							0.04	n/a

n/a - data not available

RIVER: Assiniboine River
 ZONE: 4 (Tributary)

Location	UTM (14U) NAD 83		Date	Time	Total Depth (m)	pH	Conductivity (mS/cm)	Turbidity (NTU)	Dissolved Oxygen (mg/L)	Temperature (°C)	Total Ammonia Nitrogen (mg N/L)	Unionized Ammonia (mg NH ₃ /L)
	E	N										
Sturgeon Creek (Segment 118)												
10 m upstream of confluence with Assiniboine River			16-Jul-99	13:00		7.53	0.958	95	6.80	25.1		
10 m upstream of confluence with Assiniboine River			19-Jul-99	13:10							0.04	n/a
At confluence with Assiniboine River			8-Sep-99	12:15	1.60	8.75	1.030	95	9.46	16.8	0.05	0.0091

n/a - data not available

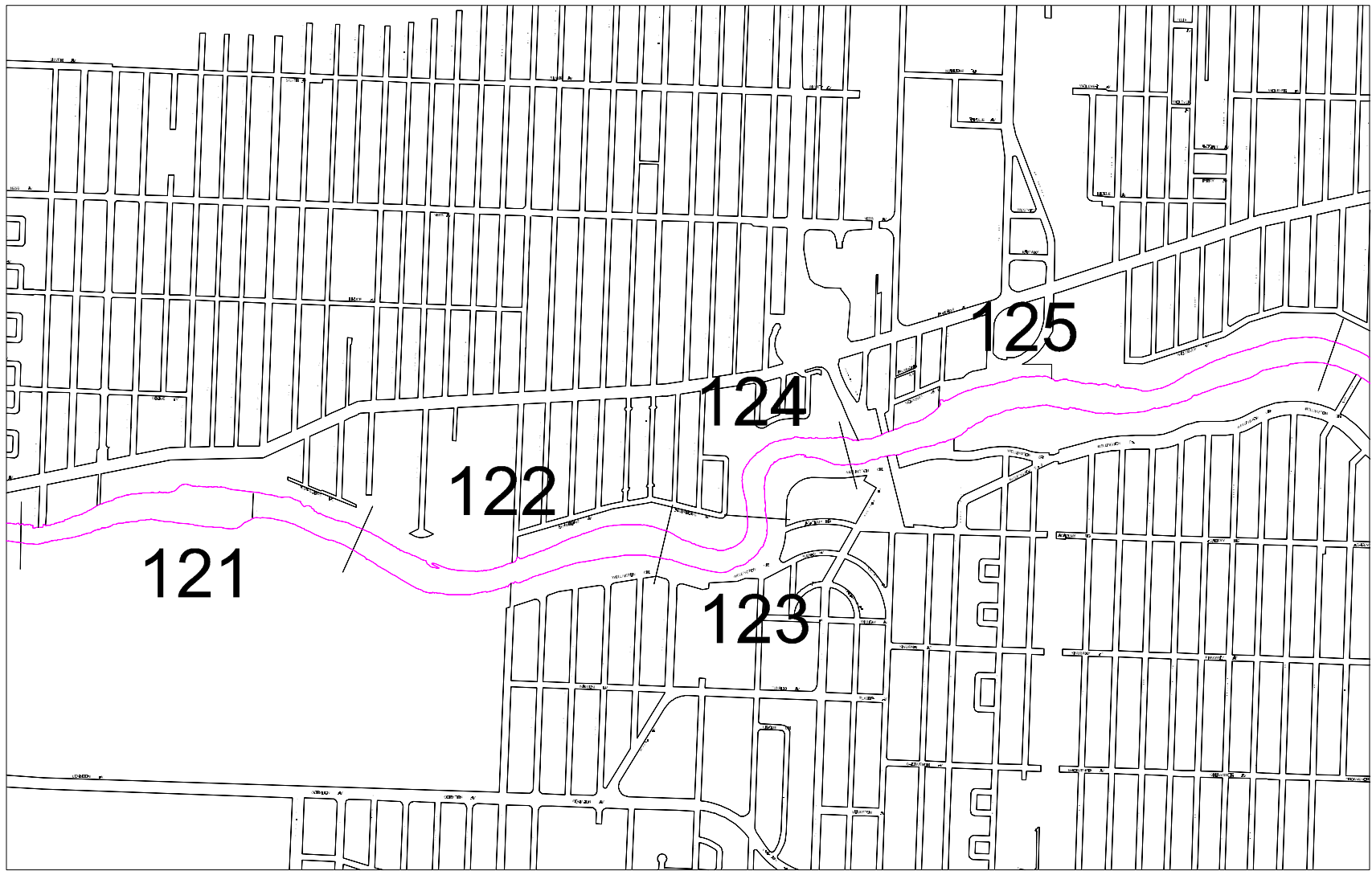

Figure 25. Assiniboine River segments 121-125.

RIVER: Assiniboine River
 ZONE: 4

Location	UTM (14U) NAD 83		Date	Time	Total Depth		Conductivity (mS/cm)	Turbidity (NTU)	Dissolved Oxygen (mg/L)	Temperature (°C)	Total Ammonia Nitrogen (mg N/L)	Unionized Ammonia (mg NH ₃ /L)
	E	N			(m)	pH						
Segment 122												
Left bank	627854	5526064	6-Mar-99	11:30	2.40	8.01	1.140	13	7.99	0.2	0.77	0.0080
Right bank			6-Mar-99	11:15	1.80	8.07	1.220	13	8.69	0.3	0.16	0.0019
Segment 123/124												
			14-Jul-99	10:40		7.97	0.977	119	5.85	22.8	0.02	0.0011
			10-Sep-99	13:05		8.64	1.030	82	9.78	14.6	0.04	0.0050
Segment 125												
10 m upstream of confluence with Omand's Creek			19-Jul-99	12:50							0.05	n/a

n/a - data not available

RIVER: Assiniboine River
 ZONE: 4 (Tributary)

Location	UTM (14U) NAD 83		Date	Time	Total Depth		Conductivity (mS/cm)	Turbidity (NTU)	Dissolved Oxygen (mg/L)	Temperature (°C)	Total Ammonia Nitrogen (mg N/L)	Unionized Ammonia (mg NH ₃ /L)
	E	N			(m)	pH						
Omand's Creek (Segment 125)												
5 m upstream of confluence with Assiniboine River			16-Jul-99	13:30		7.29	1.030	61	7.50	19.0		
10 m upstream of confluence with Assiniboine River			19-Jul-99	12:50							0.05	n/a
			10-Sep-99	15:00	1.95	8.57	1.080	88	9.96	14.6	0.12	0.0131

n/a - data not available

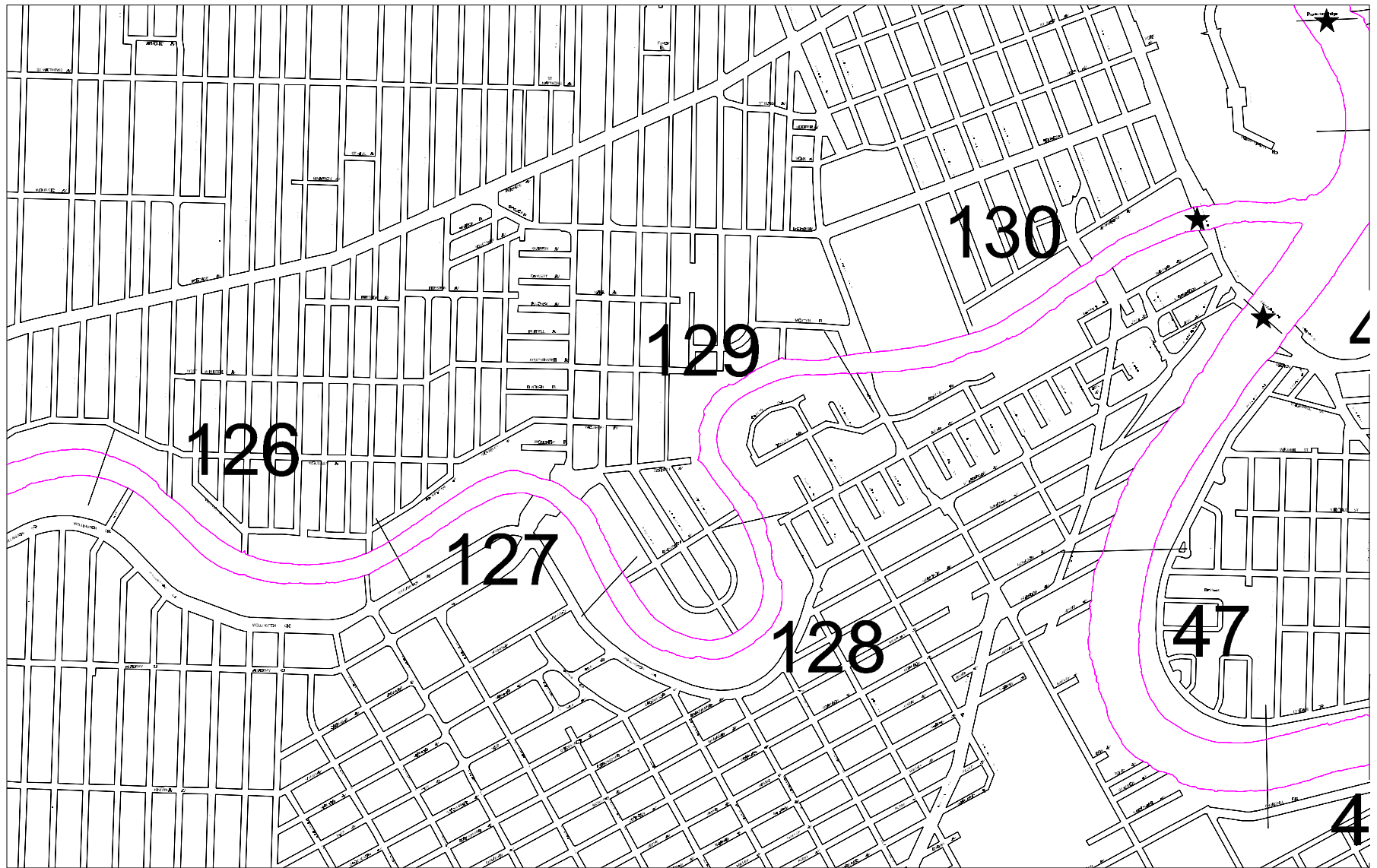

Figure 26. Assiniboine River segments 126-130.

RIVER: Assiniboine River
 ZONE: 4

Location	UTM (14U) NAD 83		Date	Time	Total Depth		Conductivity (mS/cm)	Turbidity (NTU)	Dissolved Oxygen (mg/L)	Temperature (°C)	Total Ammonia Nitrogen (mg N/L)	Unionized Ammonia (mg NH ₃ /L)
	E	N			(m)	pH						
Segment 126												
Mid-channel			28-Feb-99	11:25	2.80	7.73	1.280	17	7.06	0.2	0.50	0.0027
Right bank	630883	5526719	28-Feb-99	11:15	2.50	7.60	1.280	17	7.35	0.3	0.37	0.0015
Segment 128												
Left bank	627886	5526072	6-Mar-99		3.20	8.03	1.220	15	8.24	0.3	0.34	0.0037
Mid-channel			6-Mar-99		2.70	8.08	1.200	15	8.81	0.7	0.26	0.0033
			14-Jul-99	9:35		7.83	0.952	125	5.59	22.5	0.06	0.0023
			10-Sep-99	16:15		8.69	1.030	97	10.17	14.7	0.09	0.0127

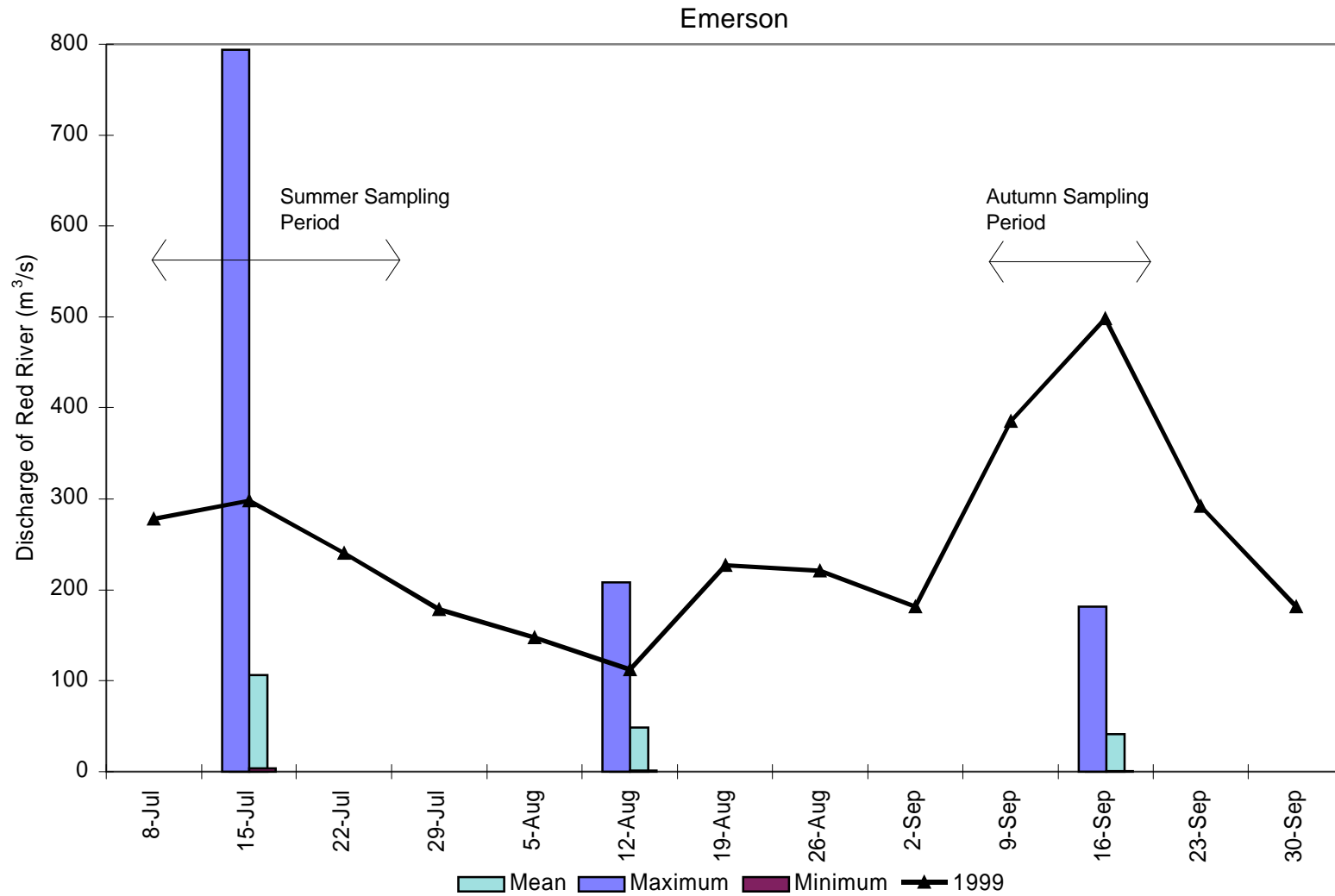

Figure 27. Comparison of historical discharge data with 1999 discharge data for the Red River at Emerson, Manitoba. Historical data based on monthly mean discharge data from 1912 - 1990 (Environment Canada 1991); 1999 data based on provisional weekly mean data provided by Manitoba Conservation, Water Resources Branch.

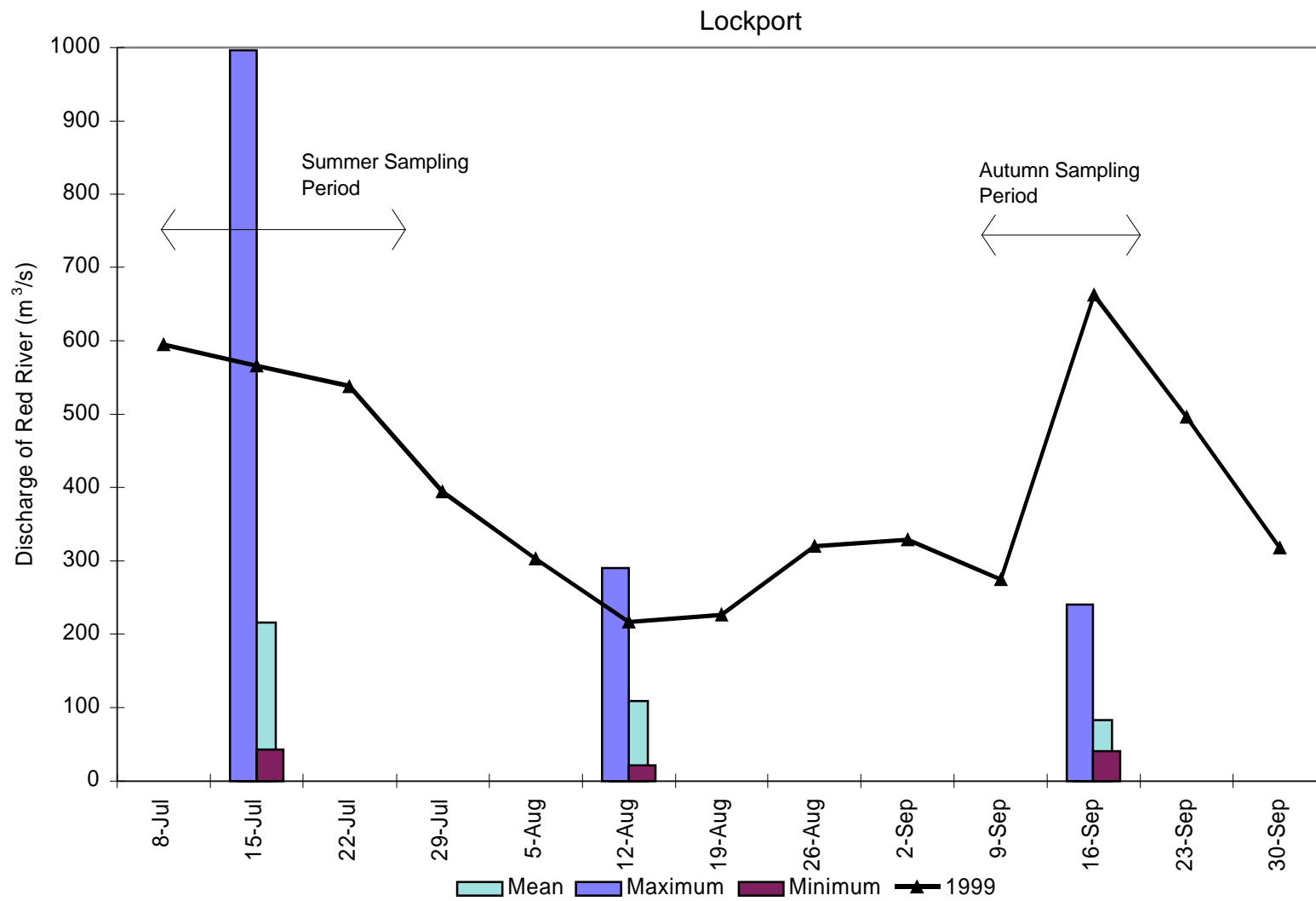

Figure 28. Comparison of historical discharge data with 1999 discharge data for the Red River at Lockport, Manitoba. Historical data based on monthly mean discharge data from 1962 - 1990 (Environment Canada 1991); 1999 data based on provisional weekly mean data provided by Manitoba Conservation, Water Resources Branch.

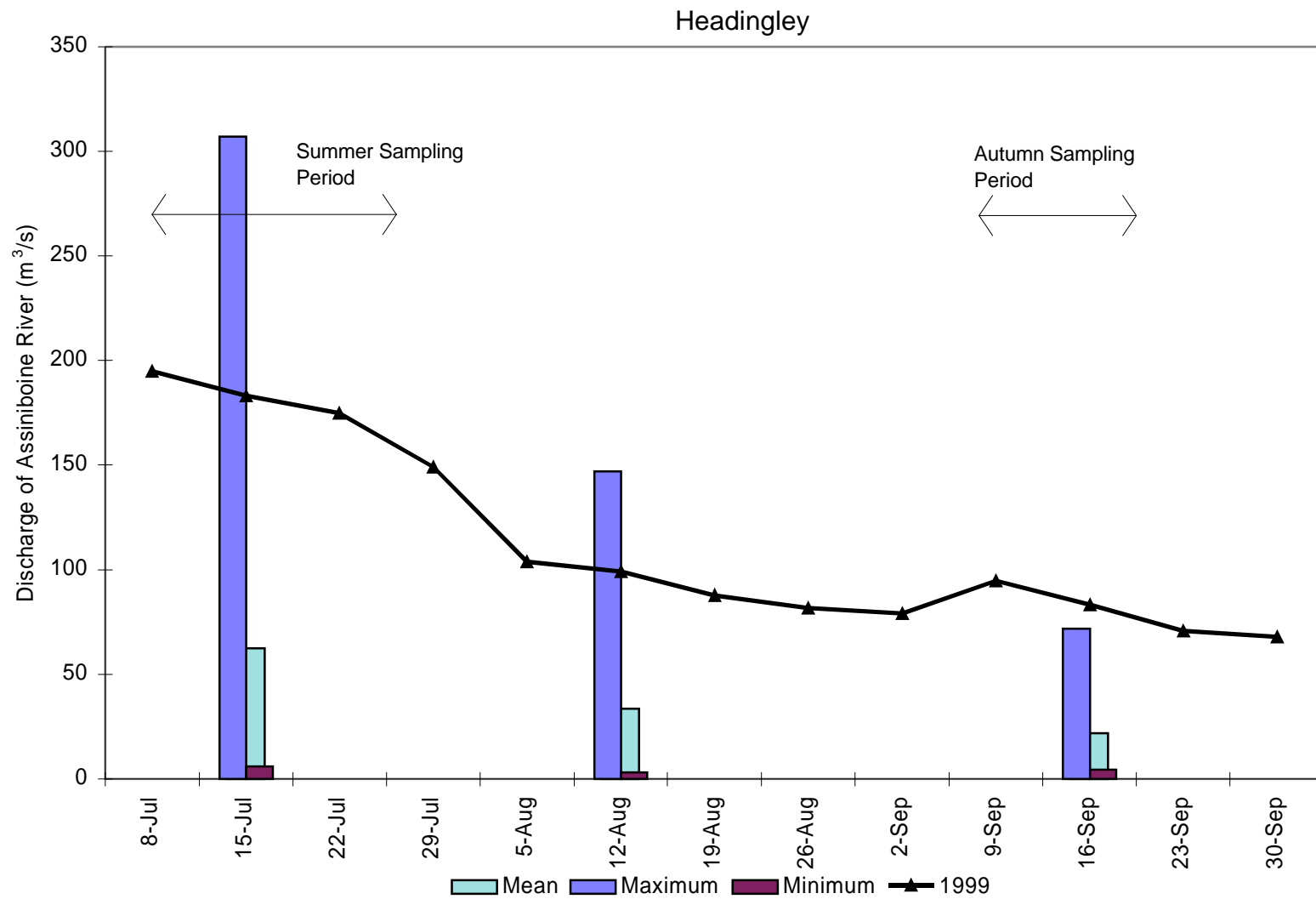

Figure 29. Comparison of historical discharge data with 1999 discharge data for the Assiniboine River at Headingley, Manitoba. Historical data based on monthly mean discharge data from 1913 - 1990 (Environment Canada 1991); 1999 data based on provisional weekly mean data provided by Manitoba Conservation, Water Resources Branch.

Appendix 1.

Summary of on-site measurements taken during sampling in the vicinity of the NEWPCC outfall, March, 1999.

Site	Position ¹	Location ²		Date	Sample Time	Water Depth (m)	Sample Depth (m)	Water Temperature (°C)	pH	Dissolved Oxygen (mg/L)	Total Ammonia (mg/L)	Unionized Ammonia ³ (mg/L)	Velocity/Depth (m/s) (m)
Outfall	RBN	E0636385	N5534730	16-Mar-99	13:35	-	0.10	1.6	8.17	9.20	5.70	0.0783	-
Net1	RBN	E0636390	N5534820	16-Mar-99	13:20	2.50	0.10	1.0	8.19	8.96	1.66	0.0227	0.10 / 1.80
Net1	RBO	E0636445	N5534825	16-Mar-99	13:25	5.80	0.10	1.1	8.60	8.80	0.66	0.0229	-
Net1	RBO	E0636445	N5534825	16-Mar-99	13:30	5.80	3.00	0.9	8.56	9.58	1.22	0.0381	0.26 / 3.50
Net2	RBN	E0636505	N5534958	16-Mar-99	13:40	3.80	0.10	1.0	8.41	9.57	1.92	0.0432	-
Net2	RBN	E0636505	N5534958	16-Mar-99	13:45	3.80	3.50	0.9	8.32	9.33	1.66	0.0303	0.12 / 2.60
Net3	LBN	E0636925	N5534865	16-Mar-99	13:15	1.70	0.50	0.7	8.16	8.68	0.55	0.0069	0.27 / 1.20
Net3	LBO	E0636935	N5534905	16-Mar-99	12:50	2.40	0.10	0.5	8.41	8.65	0.53	0.0115	-
Net3	LBO	E0636935	N5534905	16-Mar-99	12:55	2.40	1.90	0.8	8.49	8.72	0.47	0.0125	0.37 / 1.60
Net3	RBN	E0636940	N5535020	16-Mar-99	13:10	3.10	0.10	0.5	8.45	8.80	0.80	0.0189	0.36 / 2.00
Net4	LBN	E0636595	N5534255	16-Mar-99	17:30	5.05 ⁴	0.85 ⁴	0.3	-	8.77	0.21	-	0.41 / 3.00 ⁴
Outfall	RBN	E0636385	N5534730	17-Mar-99	pm	-	0.10	-	7.64	-	5.30	-	-
Net1	RBN	E0636390	N5534820	17-Mar-99	14:55	1.25	0.10	0.6	7.88	8.99	1.82	0.0119	-
Net1	RBO	E0636445	N5534825	17-Mar-99	14:50	4.50	0.10	0.6	7.87	8.83	2.44	0.0156	-
Net1	RBO	E0636445	N5534825	17-Mar-99	14:45	4.50	4.30	0.5	7.85	10.13	1.66	0.0100	-
Net2	RBN	E0636505	N5534730	17-Mar-99	15:30	3.00	0.10	0.7	7.89	9.02	1.92	0.0129	-
Net2	RBN	E0636505	N5534730	17-Mar-99	15:25	3.00	2.80	0.8	7.88	9.64	1.92	0.0128	-
Net3	LBN	E0636925	N5534865	17-Mar-99	pm	1.60	0.10	0.2	8.04	8.75	0.41	0.0037	-
Net3	LBO	E0636935	N5534905	17-Mar-99	pm	2.40	0.10	0.4	8.03	8.73	0.29	0.0026	-
Net3	LBO	E0636935	N5534905	17-Mar-99	pm	2.40	1.50	0.3	7.88	9.11	0.50	0.0032	-
Net3	RBN	E0636940	N5535020	17-Mar-99	pm	2.40	0.10	0.2	8.04	8.65	0.61	0.0056	-
Net4	LBN	E0636595	N5534255	17-Mar-99	pm	5.05 ⁴	0.85 ⁴	0.1	7.84	8.93	0.32	0.0018	-
Net61	MID	E0638969	N5537729	18-Mar-99	15:49	5.00	0.10	-	7.79	-	0.71	-	0.27 / 2.50
Net62	MID	E0639713	N5539400	18-Mar-99	15:08	1.25	0.10	-	7.93	-	0.44	-	0.37 / 0.50
Net63	MID	E0640390	N5540123	18-Mar-99	14:25	2.50	0.10	-	7.97	-	0.41	-	0.31 / 1.50
Net61	LBN	-	-	19-Mar-99	13:51	3.30	0.10	0.7	7.77	8.87	0.38	0.0019	-
Net61	MID	-	-	19-Mar-99	14:04	5.00	0.10	0.6	7.81	8.87	0.31	0.0017	-
Net61	RBN	E0638969	N5537729	19-Mar-99	14:28	2.20	0.10	0.6	7.79	9.79	0.44	0.0023	-
Net62	MID	E0639713	N5539400	19-Mar-99	12:18	-	0.10	0.4	7.73	8.91	0.23	0.0010	-
Net63	MID	E0640390	N5540123	19-Mar-99	10:45	3.10	0.10	0.5	7.82	8.84	0.44	0.0025	-
Outfall	RBN	E0636385	N5534730	22-Mar-99	11:18	-	0.10	0.8	7.97	9.05	0.20	0.0016	-
Net1	RBN	E0636385	N5534820	22-Mar-99	11:51	3.25	0.10	0.8	7.93	9.97	0.96	0.0071	-
Net1	RBN	E0636390	N5534820	22-Mar-99	11:45	3.25	3.00	0.7	7.92	10.07	1.02	0.0074	-
Net1	RBO	E0636445	N5534825	22-Mar-99	11:35	5.00	0.10	0.5	7.97	9.11	0.46	0.0037	-
Net1	RBO	E0636445	N5534825	22-Mar-99	11:27	5.00	4.50	0.2	8.03	10.27	0.38	0.0034	-

Appendix 1. (continued)

Site	Position ¹	Location ²		Date	Sample Time	Water Depth (m)	Sample Depth (m)	Water Temperature (°C)	pH	Dissolved Oxygen (mg/L)	Total Ammonia (mg/L)	Unionized Ammonia (mg/L)	Velocity/Depth (m/s) (m)
Net2	RBN	E0636505	N5534730	22-Mar-99	12:06	3.00	0.10	0.9	7.94	9.47	0.88	0.0068	-
Net2	RBN	E0636505	N5534730	22-Mar-99	12:00	3.00	2.50	0.8	7.82	9.88	1.06	0.0061	-
Net3	LBN	E0636925	N5534865	22-Mar-99	12:21	1.60	0.10	0.4	7.94	9.93	0.32	0.0024	-
Net3	MID	E0636950	N5534940	22-Mar-99	12:35	2.00	0.10	0.6	7.78	9.32	0.59	0.0031	-
Net3	MID	E0636950	N5534940	22-Mar-99	12:29	2.00	1.75	0.4	7.75	9.77	0.66	0.0031	-
Net3	RBN	E0636940	N5535020	22-Mar-99	12:42	1.75	0.10	0.7	7.73	9.60	0.83	0.0039	-
Outfall	RBN	E0636385	N5534730	23-Mar-99	9:56	-	0.10	0.4	7.56	10.07	4.10	0.0126	-
Net1	RBN	E0636390	N5534820	23-Mar-99	10:35	2.75	0.10	0.7	7.69	10.01	1.18	0.0050	-
Net1	RBN	E0636390	N5534820	23-Mar-99	10:29	2.75	2.50	0.6	7.65	10.04	1.18	0.0046	-
Net1	RBO	E0636445	N5534825	23-Mar-99	10:16	4.25	0.10	0.7	7.94	10.07	0.36	0.0027	-
Net1	RBO	E0636445	N5534825	23-Mar-99	10:08	4.25	4.00	0.2	7.79	10.77	1.14	0.0059	-
Net2	RBN	E0636505	N5534730	23-Mar-99	11:20	3.00	0.10	0.9	7.61	9.85	1.66	0.0060	-
Net2	RBN	E0636505	N5534730	23-Mar-99	11:14	3.00	2.50	0.8	7.60	10.34	1.54	0.0054	-
Net3	LBN	E0636925	N5534865	23-Mar-99	13:21	1.60	0.10	0.2	7.80	10.33	0.36	0.0019	-
Net3	MID	E0636950	N5534940	23-Mar-99	13:15	2.25	0.10	0.3	7.75	10.34	0.63	0.0030	-
Net3	MID	E0636950	N5534940	23-Mar-99	13:08	2.25	2.00	0.3	7.70	10.44	0.63	0.0027	-
Net3	RBN	E0636940	N5535020	23-Mar-99	12:57	2.25	0.10	0.7	7.78	10.40	0.59	0.0031	-

¹ codes for position: R - right; L - left; B - bank; N - nearshore (10-20 m); O - offshore (~50m); MID - mid-channel

² locations in zone 14U; measured in UTM's using NAD27

³ calculated values

⁴ depth measured from ice surface; ice thickness 0.75 m

Appendix 2. Summary of on-site measurements taken during sampling in the vicinity of the NEWPCC outfall, October, 1999.

Site	Date	Sample Time	Sample Depth (m)	Water Temperature (°C)	pH	Dissolved Oxygen (mg/L)	Total Ammonia (mg/L)	Unionized Ammonia ¹ (mg/L)
1	4-Oct-99	13:20	Surface	9.50			0.74	n/a
1	4-Oct-99		0.50	9.50				
1	4-Oct-99		1.00	9.50				
1	4-Oct-99		1.50	9.50				
1	4-Oct-99	13:18	Bottom				0.59	n/a
2	4-Oct-99	13:06	Surface	9.50			0.45	n/a
2	4-Oct-99		0.50	9.50				
2	4-Oct-99		1.00	9.50				
2	4-Oct-99		1.50	9.50				
2	4-Oct-99	13:05	Bottom				0.57	n/a
3	4-Oct-99	12:57	Surface	9.20			0.63	n/a
3	4-Oct-99		0.50	9.20				
3	4-Oct-99		1.00	9.40				
3	4-Oct-99		1.50	9.30				
3	4-Oct-99		2.00	9.30				
3	4-Oct-99		2.50	9.30				
3	4-Oct-99	12:53	Bottom				0.55	n/a
4	4-Oct-99	13:36	Surface	8.80			0.04	n/a
4	4-Oct-99		0.50	8.80				
4	4-Oct-99		1.00	8.80				
4	4-Oct-99		1.50	8.80				
4	4-Oct-99		2.00	8.80				
4	4-Oct-99		2.50	8.80				
4	4-Oct-99		3.00	8.80				
4	4-Oct-99		3.50	8.80				
4	4-Oct-99	13:32	Bottom				0.03	n/a
Outfall	4-Oct-99	13:26	Surface	11.00			0.68	n/a
1	5-Oct-99	11:45	Surface	9.10		7.59	1.80	n/a
1	5-Oct-99		0.50	9.10		7.71		
1	5-Oct-99		1.00	9.10		7.78		
1	5-Oct-99		1.50	9.10		7.88		
1	5-Oct-99	11:40	Bottom				0.56	n/a
2	5-Oct-99	12:01	Surface	9.10		8.55	1.70	n/a
2	5-Oct-99		0.50	9.10		8.67		
2	5-Oct-99		1.00	9.10		8.71		
2	5-Oct-99	11:58	Bottom				1.30	n/a
3	5-Oct-99	12:13	Surface	8.80		8.65	0.88	n/a
3	5-Oct-99		0.50	8.70		8.72		
3	5-Oct-99		1.00	8.70		8.84		
3	5-Oct-99		1.50	8.70		8.95		
3	5-Oct-99		2.00	8.80		9.21		
3	5-Oct-99		2.50	8.80		9.36		
3	5-Oct-99	12:09	Bottom				0.62	n/a
4	5-Oct-99	11:28	Surface	9.00		7.72	0.05	n/a
4	5-Oct-99		0.50	8.90		7.70		
4	5-Oct-99		1.00	8.80		7.69		
4	5-Oct-99		1.50	8.80		8.03		
4	5-Oct-99		2.00	8.70		7.99		
4	5-Oct-99	11:24	Bottom				0.11	n/a
Outfall	5-Oct-99	11:51	Surface	9.80		8.17	4.50	n/a

Appendix 2. (continued)

Site	Date	Sample Time	Sample Depth (m)	Water Temperature (°C)	pH	Dissolved Oxygen (mg/L)	Total Ammonia (mg/L)	Unionized Ammonia ¹ (mg/L)
1	6-Oct-99	11:25	Surface	9.10	7.76	7.68	2.00	0.0197
1	6-Oct-99		0.50	9.10	7.77	7.72		
1	6-Oct-99		1.00	9.00	7.78	7.73		
1	6-Oct-99		1.50	9.00	7.78	7.82		
1	6-Oct-99		2.00	9.10	7.79	8.07		
1	6-Oct-99	11:20	2.50	9.00	7.77	8.13	2.70	0.0270
2	6-Oct-99	11:35	Surface	9.10	7.83	7.81	2.80	0.0324
2	6-Oct-99		0.50	9.10	7.84	7.83		
2	6-Oct-99		1.00	9.10	7.76	7.92		
2	6-Oct-99	11:30	1.50	9.10	7.76	8.02	2.80	0.0276
3	6-Oct-99	11:45	Surface	9.00	7.95	7.87	0.90	0.0136
3	6-Oct-99		0.50	8.80	7.99	7.86		
3	6-Oct-99		1.00	8.80	8	7.93		
3	6-Oct-99		1.50	8.90	7.96	8.11		
3	6-Oct-99		2.00	8.90	7.93	8.12		
3	6-Oct-99	11:40	2.50	8.90	7.94	8.28	2.20	0.0322
4	6-Oct-99	11:05	Surface	8.70	8.35	7.61	0.02	0.0007
4	6-Oct-99		0.50	8.60	8.34	7.50		
4	6-Oct-99		1.00	8.60	8.32	7.65		
4	6-Oct-99		1.50	8.60	8.31	7.78		
4	6-Oct-99		2.00	8.50	8.29	7.93		
4	6-Oct-99		2.50	8.50	8.26	8.17		
4	6-Oct-99		3.00	8.50	8.24	8.37		
4	6-Oct-99	11:00	3.50	8.50	8.21	8.67	0.01	0.0003
Outfall	6-Oct-99	11:13	Surface	10.00	6.97	7.30	6.30	0.0109
1	7-Oct-99	9:00	Surface	9.20	7.8	7.41	3.40	0.0370
1	7-Oct-99		0.50	9.10	7.74	7.27		
1	7-Oct-99		1.00	9.10	7.81	7.46		
1	7-Oct-99		1.50	9.10	7.78	7.55		
1	7-Oct-99		2.00	8.90	7.82	7.64		
1	7-Oct-99		2.50	8.90	7.84	7.83		
1	7-Oct-99		3.00	8.90	7.83	8.12		
1	7-Oct-99	8:58	3.50	8.90	7.83	8.34	3.40	0.0387
2	7-Oct-99	9:20	Surface	8.80	8	7.76	4.50	0.0748
2	7-Oct-99		0.50	8.80	7.92	7.65		
2	7-Oct-99		1.00	8.80	7.87	7.66		
2	7-Oct-99	9:17	1.50	8.80	7.88	7.73	2.50	0.0316
3	7-Oct-99	9:30	Surface	8.30	8.32	7.85	0.32	0.0105
3	7-Oct-99		0.50	8.30	8.28	7.71		
3	7-Oct-99		1.00	8.40	8.28	7.74		
3	7-Oct-99		1.50	8.40	8.24	7.79		
3	7-Oct-99		2.00	8.40	8.24	7.91		
3	7-Oct-99	9:25	2.50	8.40	8.21	8.17	0.82	0.0212
4	7-Oct-99	8:42	Surface	8.60	8.47	7.20	0.04	0.0019
4	7-Oct-99		0.50	8.60	8.47	7.35		

Appendix 2. (continued)

Site	Date	Sample Time	Sample Depth (m)	Water Temperature (°C)	pH	Dissolved Oxygen (mg/L)	Total Ammonia (mg/L)	Unionized Ammonia ¹ (mg/L)
4	7-Oct-99		1.00	8.60	8.44	7.42		
4	7-Oct-99		1.50	8.50	8.41	7.48		
4	7-Oct-99		2.00	8.50	8.38	7.41		
4	7-Oct-99		2.50	8.50	8.35	7.63		
4	7-Oct-99		3.00	8.40	8.36	7.93		
4	7-Oct-99	8:40	3.50	8.40	8.35	8.14	0.01	0.0004
Outfall	7-Oct-99	8:54	Surface	11.00	7.34	6.77	9.60	0.0420
1	8-Oct-99	9:53	Surface	9.20	7.92	7.10	3.20	0.0458
1	8-Oct-99		0.50	9.20	7.8	7.07		
1	8-Oct-99		1.00	9.10	7.77	7.18		
1	8-Oct-99		1.50	9.10	7.76	7.23		
1	8-Oct-99		2.00	9.00	7.76	7.42		
1	8-Oct-99		2.50	9.00	7.82	7.72		
1	8-Oct-99	9:50	3.00	9.10	7.73	7.83	2.30	0.0212
2	8-Oct-99	10:12	Surface	9.00	8.02	7.38	3.00	0.0530
2	8-Oct-99		0.50	8.90	8.06	7.42		
2	8-Oct-99		1.00	8.80	8.1	7.44		
2	8-Oct-99		1.50	8.70	8.04	7.47		
2	8-Oct-99		2.00	8.70	8.04	7.55		
2	8-Oct-99	10:08	2.50	8.70	8.11	7.99	3.10	0.0655
3	8-Oct-99	10:21	Surface	8.70	8.14	7.70	1.74	0.0394
3	8-Oct-99			8.70	8.13	7.60		
3	8-Oct-99			8.70	8.12	7.63		
3	8-Oct-99			8.60	8.13	7.71		
3	8-Oct-99			8.60	8.12	7.74		
3	8-Oct-99	10:25		8.60	8.11	7.91	1.60	0.0336
4	8-Oct-99	9:38	Surface	8.70	8.4	7.15	0.03	0.0012
4	8-Oct-99		0.50	8.60	8.39	7.09		
4	8-Oct-99		1.00	8.60	8.39	7.19		
4	8-Oct-99		1.50	8.60	8.37	7.37		
4	8-Oct-99		2.00	8.50	8.35	7.48		
4	8-Oct-99		2.50	8.50	8.33	7.64		
4	8-Oct-99		3.00	8.50	8.31	7.81		
4	8-Oct-99	9:34	3.50	8.50	8.29	8.05	0.05	0.0016

¹ calculated values
n/a - data not available