

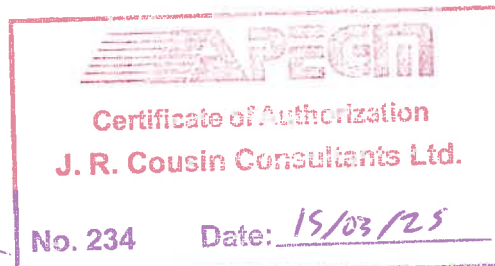

**Rural Municipality of Pipestone
Environment Act Proposal
for the
Reston Wastewater Treatment Lagoon
Upgrade/Expansion**



Prepared by:

Oswald Wohlgemut, M.Sc.
Environmental Scientist

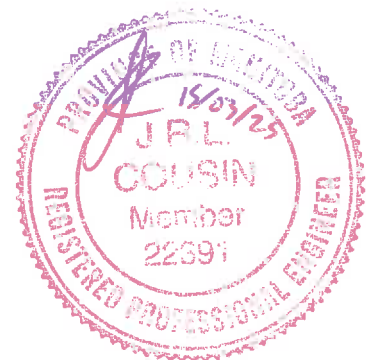

Reviewed by:

Jason Cousin, P.Eng.
Senior Municipal Engineer

March 2015



ACKNOWLEDGMENTS

To prepare this report various sources of information were investigated and researched. JR Cousin Consultants Ltd. (JRCC) wishes to thank the RM of Pipestone and the Manitoba Water Services Board (MWSB) who contributed to the data and content of this study. In addition, we wish to commend the RM of Pipestone and the Manitoba Water Services Board for their fortitude in addressing the need for a long-term solution to wastewater treatment for the Community of Reston.

REMARKS

JR Cousin Consultants Ltd. has conducted this environment act proposal in accordance with generally accepted professional engineering principles and practices for the purpose of identifying conditions that may have an environmental impact on the site. The findings and recommendations reached in this report are based on information made available to JRCC during the investigation and conditions at the time of the site investigation. Conclusions derived in this report are intended to reduce, but not wholly eliminate the uncertainty regarding potential environmental concerns on the site, and recognizes reasonable limitations with regards to time, accuracy, work scope and cost. It is possible that environmental conditions may change from the date of this report. If conditions appear different from those encountered and expressed in this report, JRCC should be informed so that mitigation recommendations can be reviewed and adjusted as required. Historical data and information obtained from personal communication used in this report, are assumed to be correct, however JRCC has not conducted further investigations into the accuracy of this data. JRCC has produced this report for the use of the client, and takes no responsibility for any third party decisions or actions based on information contained in this report.

TABLE OF CONTENTS

Section	Page of Section
ENVIRONMENT ACT PROPOSAL FORM	i
EXECUTIVE SUMMARY	1
1.0 INTRODUCTION AND BACKGROUND	1
1.1 Introduction.....	1
1.2 Contact Information.....	1
1.3 Background Information.....	1
1.4 Description of Previous Studies.....	2
2.0 DESCRIPTION OF THE DEVELOPMENT	1
2.1 Land Title/Location.....	1
2.2 Owner of Land and Mineral Rights.....	1
2.3 Existing Land Use.....	1
2.4 Land Use Designation/Zoning Designation.....	2
2.5 Description of Development.....	2
2.5.1 Project Schedule.....	2
2.5.2 Basis for Proposed Lagoon Upgrading Site Selection.....	2
2.5.3 Existing Lagoon Drainage Route.....	3
2.5.3.1 Fish Species Information.....	4
2.5.3.2 Water Quality Information.....	4
2.5.4 Access Road.....	4
2.5.5 Population Contributing Effluent.....	5
2.5.5.1 Reston.....	5
2.5.5.2 Reston Commercial.....	5
2.5.5.3 Reston School.....	5
2.5.5.4 Rural Population.....	6
2.5.5.5 Population Summary Table.....	6
2.5.6 Wastewater Production.....	6
2.5.6.1 Organic Loading.....	7
2.5.6.2 Hydraulic Loading.....	8
2.5.7 Existing Lagoon Assessment and Capacity.....	9
2.5.7.1 Lagoon Assessment.....	9
2.5.7.2 Existing Organic Capacity.....	9
2.5.7.3 Existing Hydraulic Storage Capacity.....	10
2.5.8 Lagoon Sizing Requirements.....	10
2.5.8.1 Design for Expansion of the Existing Lagoon.....	10
2.5.9 Topography and Geotechnical Investigation.....	11
2.5.9.1 Topography.....	11
2.5.9.2 Past Geotechnical Data.....	12
2.5.9.3 Site Investigation.....	13
2.5.9.4 Laboratory Analysis.....	15
2.5.10 Design Guidelines.....	17
2.5.11 Typical Lagoon Liner Construction Options.....	17

Section	Page of Section
2.5.12 Proposed Lagoon Expansion Liner Design	17
2.5.13 Review of Regulatory Requirements	18
2.5.13.1 Organic Loading.....	18
2.5.13.2 Hydraulic Loading.....	18
2.5.13.3 Lagoon Liner	18
2.5.13.4 Effluent Quality Requirements	18
2.5.14 Nutrient Management Plan	19
2.5.15 Upgraded Lagoon Design Requirements	21
2.5.15.1 Primary Cell	21
2.5.15.2 Storage Cells	22
2.5.15.3 Cell Repairs.....	22
2.5.15.4 Summary of Selected Design Criteria	23
2.5.16 Lagoon Construction Details.....	24
2.5.17 Decommissioning.....	25
2.5.18 Lagoon Maintenance.....	25
3.0 POTENTIAL ENVIRONMENTAL IMPACTS.....	1
3.1 Releases to Air, Water, Land	1
3.1.1 Air.....	1
3.1.2 Water.....	1
3.1.3 Land	2
3.2 Wildlife	2
3.3 Fisheries.....	2
3.4 Forestry.....	3
3.5 Vegetation.....	3
3.6 Noise Impacts	3
3.7 Health and Safety	3
3.8 Heritage Resources.....	3
3.9 Socio-Economic Implications	3
3.10 Aesthetics	4
4.0 MANAGEMENT PRACTICE	1
4.1 Mitigation of Impacts to Air	1
4.2 Mitigation of Impacts to Water	1
4.3 Mitigation of Impacts to Land.....	2
4.4 Mitigation of Noise Impacts	3
4.5 Mitigation of Impacts to Health and Safety.....	3
4.6 Mitigation of Impacts to Heritage Resources	3
5.0 RESIDUAL AND CUMULATIVE EFFECTS.....	1
6.0 MONITORING AND FOLLOW-UP.....	1
7.0 FUNDING AND APPROVALS	1
8.0 PUBLIC CONSULTATION	1
9.0 CONCLUSION.....	1

Appendix A

Land Title

Crown Lands & Property Agency - Lands Branch, March 17, 2014 Email Correspondence

Appendix B

Table 1: Reston Lagoon Population, Hydraulic, and Organic Loading Projections to Design Year 20

Manitoba Conservation and Water Stewardship - Wildlife and Ecosystem Protection Branch, January 2, 2014 Email Correspondence

Manitoba Culture, Heritage, Tourism and Sport – Historic Resources Branch, January 13, 2014 Email Correspondence

Manitoba Conservation and Water Stewardship - Fisheries Branch, January 17, 2014 Email Correspondence

Appendix C

Test Hole Logs

National Testing Laboratories Ltd. Soils Analysis Report, October 11, 2013

National Testing Laboratories Ltd. Soils Analysis Report, November 8, 2013

Stantec Consulting Ltd. Soils Analysis Report, August 28, 2014

Stantec Consulting Ltd. Soils Analysis Report, October 6, 2014

Driller's Well Logs

Appendix D

Title Page

Plan L1: Existing Lagoon and Test Hole Plan

Plan L2: Expanded Lagoon with Setbacks

Plan L3: Proposed Lagoon Layout Plan

Plan L4: Proposed Lagoon Drainage Route

Plan L5: Lagoon Dike Details

Plan L6: Lagoon Fence, Silt Fence, Valve and Rip Rap Details

Environment Act Proposal Form

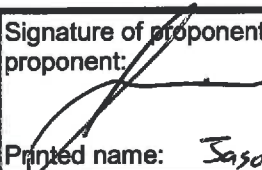

Name of the development: Reston Wastewater Treatment Lagoon Upgrade/Expansion	
Type of development per Classes of Development Regulation (Manitoba Regulation 164/88): Class 2	
Legal name of the applicant: Rural Municipality of Pipestone	
Mailing address of the applicant: Box 99, 401 - 3rd Avenue	
Contact Person: Ms. June Greggor	
City: Reston	Province: Manitoba Postal Code: R0M 1X0
Phone Number: (204) 877-3327	Fax: (204) 877-3999 email: admin@rmofpipestc
Location of the development: Rural Municipality of Pipestone	
Contact Person: Ms. June Greggor	
Street Address:	
Legal Description: NE 5-7-27 WPM	
City/Town: RM of Pipestone	Province: Manitoba Postal Code: R0M 1X0
Phone Number: (204) 877-3327	Fax: (204) 877-3999 email: admin@rmofpipestc
Name of proponent contact person for purposes of the environmental assessment: Jason Cousin, JR Cousin Consultants Ltd.	
Phone: 204-489-0474	Mailing address: 91 A Scurfield Blvd
Fax: 204-489-0487	Winnipeg, Manitoba
	R3Y1G4
Email address: jrccousin@jrcc.ca	
Webpage address: www.jrcc.ca	
Date: 15/03/25	Signature of proponent, or corporate principal of corporate proponent: 
	Printed name: Jason Cousin

EXECUTIVE SUMMARY

General

The RM of Pipestone has requested assistance from the Manitoba Water Services Board (MWSB) to upgrade and expand the existing wastewater treatment lagoon for the Local Urban District (LUD) of Reston, Manitoba. An Environment Act Licence will be required from Manitoba Conservation for the construction and operation of the proposed expanded and upgraded lagoon. JR Cousin Consultants Ltd. (JRCC) was retained for the engineering services.

Description

The existing Reston wastewater treatment lagoon is at hydraulic and organic capacity and is in need of upgrading and expansion due to the proposed future expansion of the community. The most feasible option considered by the Project Team was lagoon expansion by constructing two new storage cells (Storage Cell #3 and #4) to the southeast and east of the existing cells, and to combine the existing primary cell with Storage Cell #1 to form an expanded primary cell, to increase capacity. In addition, significant erosion has occurred on the inner slopes of the existing storage cells that require repair. Repairs to the existing cells would include addition of compacted clay soil material and rip rap stone along the inner slopes of existing Storage Cells #1 and #2, to prevent future erosion. A perimeter fence would be installed around the new Storage Cells #3 and #4.

Population Contributing Effluent

The projected year 20 population used for sizing the upgraded and expanded lagoon consists of: the residential population in Reston (1,000 people), the equivalent commercial population from the community (8 people) the equivalent population of bussed in students and staff at the school (34 people), and the surrounding rural residents (638 people). The residential population is projected to experience an annual population growth of approximately 3.04%, the school population is projected to experience an annual population growth of approximately 0.4%, and the rural population is projected to experience an annual population growth of 0.4%. Therefore, the total equivalent population projected to be contributing effluent in year 20 from the piped collection system in the community is 1,042 people, and the projected population from the surrounding rural residents truck hauling wastewater is approximately 638 people.

Lagoon Loading

The total projected year 20 organic loading to the lagoon primary cell would be approximately 91.6 kg BOD₅/day, which considers average daily loading from the community and a peak daily load of septage from the surrounding rural residents (three tank pump outs per day or one truckload of septage per day).

Based on a per capita hydraulic loading rate of 371 L/person/day, the projected year 20 hydraulic load to the lagoon would be approximately 387 m³/day. Therefore, the lagoon would require a total hydraulic capacity of 88,920 m³ in year 20 for 230 days of storage, which was utilized in design for sizing the new lagoon storage cells.

Lagoon Capacity

Based on a review of the existing lagoon “as constructed” drawings, the lagoon expanded primary cell would have an organic loading capacity of 147.6 kg BOD₅/day which would be more than sufficient for the projected organic loadings in year 20. The expanded lagoon would have a total hydraulic storage capacity of 89,089 m³, which would be sufficient, for a 230 day storage period in year 20, based on the projected hydraulic loadings.

Topographical Survey and Geotechnical Investigation

The general area adjacent to the lagoon to the southeast was gently undulating grassland, with the exception of a low lying area used previously as a soil borrow area in the original lagoon construction. The land generally slopes towards the north. The previous borrow area is located in the central portion of this expansion area and has an elevation of approximately 2 to 3 m below the ground elevation in the remainder of the southeast expansion area.

The expansion area to the east of the Manitoba Hydro transmission lines was a mixture of undulating grassland and wetlands. The low lying wetland areas are utilized as part of the lagoon discharge route, and contained areas of standing water and wetland vegetation (cattails and reeds), while the grassland area is proposed for the construction of the lagoon cells. The surface of the grassland area has a general slope towards the east however is undulating throughout the area.

The general soil profile to the southeast consisted of a thin layer of surficial black topsoil followed by a layer of sand and sandy clay down to a depth of 0.5 m - 0.8 m below the surface. Below this was a layer of medium plastic, sandy clay down to approximately 3.5 m – 4.8 m below the surface, followed by layers of clay till and silt till to the bottom of the test holes at 6.0 m. The general soil profile to the east consisted of a thin layer of surficial topsoil followed by a layer of silty clay and/or low plastic sandy clay down to approximately 4.5 m – 6.0 m, followed by a layer of high plastic sandy clay. Refusal or bedrock was not encountered at any of the test holes. Standing water was recorded in two of the test holes (TH12 and TH16) at depths ranging from 4.1 m to 4.4 m below the surface.

Based on the laboratory analysis, the layer of medium plastic silty and sandy clay had an in situ hydraulic conductivity value of 1.3×10^{-6} cm/sec, and a hydraulic conductivity value of 5.5×10^{-9} cm/sec and 1.2×10^{-8} cm/sec after re-working. The existing lagoon dikes had an in situ hydraulic conductivity value of 1.9×10^{-8} cm/sec, which is within the Manitoba Conservation requirements for hydraulic conductivity in a lagoon liner.

Lagoon Liner

Based on the onsite geotechnical investigation and laboratory analysis, it is proposed that the lagoon liner in Storage Cells #3 and #4 be constructed of reworked clay soils from the site excavation. The hydraulic conductivity analysis of the soils in the expansion area indicated that the soils would achieve a hydraulic conductivity value less than 1×10^{-7} cm/sec after re-working, as required by Manitoba Conservation for clay lined lagoons. The hydraulic conductivity analysis of the soils in the existing lagoon dikes indicated that the existing soils would achieve a hydraulic conductivity value of less than 1×10^{-7} cm/sec, which was originally constructed from the reworked silty clay soil material observed at the site.

Nutrient Management Plan

Based on the 2011 *Manitoba Water Quality Standards, Objectives and Guidelines*, the municipal wastewater effluent discharge requirement is a limit of 1.0 mg/L of phosphorus. The exception being small wastewater treatment facilities that serve less than 2,000 equivalent people, which have the option of implementing a nutrient reduction strategy instead of the 1.0 mg/L phosphorus limit.

Various options were considered for meeting the required phosphorus limit, however the most feasible option included utilizing a trickle discharge from the lagoon into the existing wetland area to the east to increase nutrient uptake along the discharge route, prior to discharge into the nearest body of surface water (Stony Creek).

1.0 INTRODUCTION AND BACKGROUND

The development described herein is for upgrading the existing wastewater treatment lagoon in the Local Urban District (LUD) of Reston, in the RM of Pipestone, Manitoba.

1.1 Introduction

The RM of Pipestone and the Manitoba Water Services Board (MWSB) are proposing to upgrade and construct an expansion to the existing wastewater treatment lagoon for Reston, Manitoba. A lagoon expansion is required to accommodate the future proposed growth in Reston. In addition, repairs are required on the inner slope of the existing storage cell due to significant erosion. An Environment Act Licence is required from Manitoba Conservation for the construction and operation of the proposed lagoon expansion and upgrade. JR Cousin Consultants Ltd. (JRCC) was retained for the related engineering services.

1.2 Contact Information

Mr. Jason Cousin, P.Eng.
JR Cousin Consultants Ltd.
91A Scurfield Boulevard
Winnipeg, Manitoba
R3Y 1G4
Phone: (204) 489-0474, Fax (204) 489-0487

Ms. June Greggor, CAO
Rural Municipality of Pipestone
Box 99
401 - 3rd Avenue
Reston, Manitoba
R0M 1X0
Phone: (204) 877-3327, Fax (204) 877-3999

Ms. Dee Genaille, P. Eng.
Manitoba Water Services Board
PO Box 22080
2010 Currie Boulevard
Brandon, Manitoba
R7A 6Y9
Phone: (204) 726-6080, Fax (204) 726-7196

1.3 Background Information

Reston is located approximately 88 km southeast of Brandon, Manitoba, along PTH 2, in the RM of Pipestone. The existing lagoon site is located at NE 5-7-27 WPM, to the southwest of the residential centre of Reston. The service population utilizing the Reston lagoon will include residential and

commercial populations within Reston, bussed in students at the public school, and surrounding rural residents. The residents within Reston are currently serviced with a gravity sewer collection system, while the surrounding rural residents utilize septic systems with truck hauling of septage to the lagoon.

The Reston wastewater treatment lagoon was constructed in 2002 with a primary cell and two storage cells of compacted clay soils. The lagoon is currently being operated under Environmental Licence No. 2564, issued in 2002. Due to the proposed expansion and upgrade a new Environmental Act Licence will be required. This lagoon currently discharges to a low lying wetland area to the east of the lagoon cells. Based on a planned residential development within Reston, the wastewater treatment lagoon is in need of expansion to increase capacity.

1.4 Description of Previous Studies

A total of four previous reports for Reston were reviewed. The most recent report was the 2015 *RM of Pipestone Feasibility Study for Reston Lagoon Upgrade*, prepared by JR Cousin Consultants Ltd. This report discusses the various options for lagoon expansion and upgrading, complete with cost estimates for the recommended options.

A Lagoon Capacity Review Report, prepared by Genivar Consultants Ltd. in November 2012 was reviewed. The report assessed the hydraulic and organic capacity of the existing lagoon.

Stantec Consulting Ltd. prepared a 2002 report entitled *Reston Wastewater Lagoon Feasibility Study*. This report discussed the water and wastewater demands from the community, the contributing population and the existing lagoon capacity. This report was written prior to the 2002 lagoon expansion.

JR Cousin Consultants Ltd. prepared a report entitled *RM of Pipestone Sites Soil Report for Reston Wastewater Lagoon*, in June 2000. This report reviewed potential lagoon locations and soils for the potential lagoon sites.

The Stantec “As Constructed” plans of the Reston lagoon construction [2002] were also reviewed to assess the current organic and hydraulic capacity of the lagoon, and to review the construction details.

2.0 DESCRIPTION OF THE DEVELOPMENT

For each heading there is an information request from the Environment Act Proposal Form. These requests are repeated herein in italics followed by the pertaining response.

2.1 Land Title/Location

Certificate of Title showing the owner(s) and legal description of the land upon which the development will be constructed; or, in the case of highways, rail lines, electrical transmission lines, or pipelines, a map or maps at a scale no less than 1:50,000 showing the location of the proposed development:

The existing lagoon is located in NE 5-7-27 WPM, while the proposed lagoon expansion will be located east of the existing lagoon, also within NE 5-7-27 WPM. The RM of Pipestone currently owns the land of the proposed expansion. A copy of the current Certificate of Title (No. 1891748/2) for the land on which the lagoon expansion is proposed is attached in Appendix A. The location of the existing lagoon and proposed expansion layout is included on Plans L1 and L2 in Appendix D.

2.2 Owner of Land and Mineral Rights

Owner of land upon which the development is intended to be constructed, and of mineral rights beneath the land, if different from surface owner:

Based upon the Certificate of Title for the proposed expansion area, the land is owned by the RM of Pipestone and the Mines and Minerals are owned with the surface title. The Crown Lands & Property Agency was contacted regarding the location of the proposed development for comment on the land title. According to the Crown Lands & Property Agency, one-third of the mines and minerals are privately owned, which includes interest in all petroleum, natural gas and related hydrocarbons. The ownership of the remaining two-thirds of the mines and minerals is unknown; however, the sand and gravel resources may stay with the surface title, which is owned by the RM. Refer to the Crown Lands & Property Agency's March 17, 2014 email correspondence, attached in Appendix A.

2.3 Existing Land Use

Existing land use on the site and on land adjoining it, as well as changes that will be made in such land use for the purposes of the development:

The proposed lagoon expansion site is the land directly east and southeast of the existing lagoon cells. The land to the southeast appeared to be abandoned grassland during the site investigation, while the land to the east is grassland with low lying wetland areas and also contains a utility corridor for overhead Hydro transmission lines. The surrounding lands to the south, north and west are agricultural and are currently being used for grain production.

Soil would be excavated in the area of the proposed lagoon expansion, for construction of the lagoon cell dikes and surrounding drainage ditches. The existing access road (Government Road South) would continue to be utilized for maintenance vehicles and for truck haul dumping.

2.4 Land Use Designation/Zoning Designation

Land use designation for the site and adjoining land as identified in a development plan adopted under The Planning Act or The City of Winnipeg Act, and the zoning designation as identified in a zoning by-law, if applicable:

The lagoon expansion site is zoned as Agricultural General, based on zoning designations in the RM of Pipestone.

2.5 Description of Development

Description of proposed development and schedule for stages of the development, including proposed dates for planning, design, construction, commissioning, operation, and decommissioning and/or termination of operation (if known), identifying major components and activities of the development as applicable (e.g. access road, airstrip, processing facility, waste disposal area, etc.).

2.5.1 Project Schedule

The lagoon expansion/upgrade design is proposed to begin upon receipt of the Environment Act Licence with site works beginning in the fall of 2015. Commissioning and operation of the lagoon would begin upon completion of construction and after approval for use is obtained from Manitoba Conservation. No date for decommissioning has been set for the lagoon; however, a lagoon assessment should be conducted when the lagoon approaches the year 20 design life.

2.5.2 Basis for Proposed Lagoon Upgrading Site Selection

The locations for the lagoon expansion were chosen based on discussions with the Project Team, considering proximity to the existing residences, future development, and adjacent property boundaries as well as utilizing the existing infrastructure.

Manitoba Conservation's guidelines for the location of a wastewater treatment lagoon (*Design Objectives for Standard Sewage Lagoons, Province of Manitoba, Environmental Management, July 1985*) are outlined in the following table. A description of the proposed site in relation to each of the guidelines is also provided in the table.

Table A: Location of Proposed Lagoon Expansion Site in Relation to Manitoba Conservation Guidelines

Manitoba Conservation Guideline	Proposed Relation to Site
Lagoons must be located a minimum of 460 m from any community centre.	The proposed lagoon expansion area is located beyond the 460 m setback from the residential centre of Reston.
Lagoons must be located a minimum of 300 m from any residence. (The distance is to be measured from the centreline of the nearest dike).	The proposed lagoon expansion area is located beyond the 300 m setback from the nearest resident.

Manitoba Conservation Guideline	Proposed Relation to Site
Consideration should be given to sites in which prevailing winds are in the direction of uninhabited areas.	The prevailing winds are typically from the north and west. The proposed lagoon expansion area is located south and west of Reston.
Sites with an unobstructed wind sweep across the lagoon are preferred.	The proposed lagoon expansion area is located in an open area surrounded by agricultural land.
Areas that are habitually flooded shall be avoided.	The proposed lagoon expansion area is not located in an area that is habitually flooded. The dikes of the proposed lagoon expansion would be constructed at elevations of 1 m to 3 m above the existing ground surface.
Sewage lagoons are to be designed and constructed such that the interior surface of the proposed lagoon is underlain by at least one metre of soil having a hydraulic conductivity of 1×10^{-7} cm/sec or less. In areas sensitive to groundwater contamination or without suitable soils, a flexible synthetic liner may be utilized.	As the excavated soils at the site can provide a consistent permeability of less than 1×10^{-7} cm/sec when re-worked, the lagoon expansion/upgraded cells will be lined with a re-worked soil liner to provide containment.

The lagoon expansion area is located beyond all setback distances required by Manitoba Conservation and is in an area that meets other provincial siting requirements; therefore, there are no expected concerns for the location of the expansion cells. Plan L2 in Appendix D, shows the minimum setback distance requirements for the expanded lagoon to the nearby residences and the population centre. While no flooding at the lagoon site has been reported, the proposed expansion areas are located adjacent to low lying wetland areas to the southeast and east of the existing cells, which is utilized as the existing lagoon discharge route. Surface flow in this area was reported to be towards the southeast, away from the lagoon, which was confirmed through a topographic investigation, therefore issues with flooding at the lagoon expansion sites are unlikely. A portion of the expansion area to the southeast was also identified as a past borrow pit during the original lagoon construction and therefore is low lying, with standing surface water. This portion of the expansion area will be filled in as part of the expansion cell construction.

2.5.3 Existing Lagoon Drainage Route

The proposed lagoon expansion would utilize the existing discharge route that extends east of the existing storage cell, through a low lying natural wetland area and into the municipal road ditches that flow southeast for approximately 10 km and eventually connect with Stony Creek (Third Order Provincial Drain). From this point Stony Creek flows approximately 10 km northeast to Maple Lake (See Plan L4 in Appendix D). The ground along the drainage route is reported to be sandy, and it is expected that the treated effluent will seep into the soils along the drainage route and are unlikely to impact surface waters downstream.

2.5.3.1 Fish Species Information

Fathead minnows and brook stickleback have been identified in Stony Creek, according to the Fisheries Inventory Habitat and Classification System (FIHCS). Fisheries information was also available from a fish distribution study conducted by AEC Ltd. for the West Souris Conservation District, which listed the following additional fish species in Stony Creek: northern pike, white sucker, emerald shiners, longnose dace, Johnny darter, and blackside darter.

According to the FIHCS, Stony Creek is rated as a Class 4 water body, which has severe limitations. The AEC study indicated that Stony Creek would be rated as having a low value fish habitat. Email correspondence with Manitoba Conservation and Water Stewardship – Fisheries Branch, is included in Appendix B.

2.5.3.2 Water Quality Information

Manitoba Conservation and Water Stewardship were contacted for water quality data in Stony Creek. Historic water quality data was available for Stony Creek and average values are summarized in the table provided below. Samples were retrieved from the nearest monitoring station to the lagoon site (No. MB05NGS084), which is located southeast of Reston, Manitoba, approximately 15 km southeast of the proposed lagoon expansion site. The samples were recorded between April 1997 and April 2009.

Table B: Average Water Quality in the Stony Creek

Parameter	Average Concentration	Unit
Ammonia Dissolved	0.06	mg/L
Coliforms, Fecal	<10	MPN/100 mL
E. Coli	<10	CFU/100 mL
Conductivity (at 25 °C)	615	uS/cm
pH	7.86	pH units
Nitrogen Dissolved NO ₃ & NO ₂	0.11	mg/L
Nitrogen Total Kjeldahl (TKN)	1.74	mg/L
Oxygen Dissolved	6.55	mg/L
Total Phosphorus (TP)	0.28	mg/L
Total Phosphorus Dissolved	0.21	mg/L
Total Dissolved Solids (TDS)	455.77	mg/L
Total Suspended Solids (TSS)	8.68	mg/L

2.5.4 Access Road

The lagoon site has an existing all-weather access road (Government Road South) that would continue to be utilized for maintenance vehicles and for truck dumping after the lagoon expansion. The access road approach and truck turnaround area was constructed from granular

material and appeared to be in good condition, along with the concrete spillway into the existing primary cell.

2.5.5 Population Contributing Effluent

Population data was obtained from Statistics Canada and the August 27, 2013 meeting with the RM of Pipestone. The service population utilizing the Reston lagoon includes residents within Reston, the Reston School and the surrounding rural residents.

2.5.5.1 Reston

Reston consists of residential and commercial populations. Statistics Canada reported a population for Reston of 550 people in 2011. There are three planned developments in Reston. The first planned development is a 24 lot residential subdivision. Utilizing the average population per household (2.2 people/household) within Reston, as reported by Statistics Canada, the expected population increase would be 53 people. The second planned development is a 20 unit seniors complex. The seniors complex is anticipated to have double occupancy, resulting in a growth of 40 people. The third development is land Reston has recently purchased east of town. There are currently no lots identified, however an allowance for a growth of 357 people has been included (as per discussion with the RM). Reston is projected to have a year 20 population of approximately 1,000 people, resulting in an annual growth rate of 3.04%.

2.5.5.2 Reston Commercial

Reston is expected to undergo a population increase of seven commercial lots within a new subdivision development. There are currently no planned wet industries being developed within Reston. The current population of commercial people working in, but not living in Reston is estimated to be 15 people. The commercial population is assumed to have an occupancy equivalence of 1/3, based on the amount of time spent at the commercial facilities, and would therefore represent an equivalent population of 5 people (15/3). Within the proposed seven commercial lots, it is assumed that one person at each new lot will not live in Reston, increasing the commercial population by 3 (7/3). Therefore the year 20 equivalent commercial population is estimated to be 8 people.

2.5.5.3 Reston School

The Reston School includes students from Kindergarten to Grade 12 and services Reston and surrounding RM of Pipestone. Based on discussions with the Fort La Bosse School Division on August 19, 2013, the additional population to consider from the bussed-in students is 94. The population of bussed in students would have an assumed occupancy of 1/3 the population, based on the amount of time spent at school, and would therefore represent an equivalent population of 31 people (94/3).

The population of the school is estimated to have a growth rate matching the RM of 0.4%, therefore the year 20 equivalent population is estimated to be 34 people.

2.5.5.4 Rural Population

Additional wastewater loading from other sources would include the population from the surrounding rural residents in the RM of Pipestone. Statistics Canada reported an RM of Pipestone population of 1,447 people in 2011. The community of Pipestone has an estimated population of 154 people on the piped system and Reston has a population of 550 people, leaving a balance on 743 people in the RM. Based on the location of the Reston lagoon and the Pipestone lagoon, which both service the RM, it is assumed that 80% of the trucked septic load will go to the Reston lagoon and 20% of the trucked septic load will go to the Pipestone lagoon, resulting in 594 people assumed to currently have septic truck service to the Reston lagoon. This population would be considered for truck hauling to the lagoon from the surrounding rural community. The RM of Pipestone population has been growing at 0.4% per year from 2006 to 2011. Therefore, a 0.4% growth rate was considered for the surrounding rural population to design year 20.

2.5.5.5 Population Summary Table

The current and projected populations for the service area have been included in the summary table below and in Table 1 of Appendix B.

Table C: Summary of Population for the Service Area

Contributing Population	Current Population	Year 20 Population
Reston	550	1000
Reston Commercial	5	8
Reston School	31	34
Rural Population	594	638

The residential, commercial and school populations all utilize a gravity sewer collection system, while the rural residents utilize septic fields and truck hauling for septage disposal. Therefore, the total projected year 20 population estimated to utilize the gravity sewer collection system is 1,042 people and the projected rural service population is 638 people.

2.5.6 Wastewater Production

Reston currently utilizes a gravity sewer collection system for the collection of residential wastewater, and utilizes lift station pumps to send the influent to the lagoon primary cell. Truck haul dumping of septic tank wastewater also occurs in the lagoon primary cell. The expanded wastewater treatment lagoon is to service the projected year 20 populations as stated above, for Reston, school and rural residents.

2.5.6.1 Organic Loading

The organic loading calculation is based upon the organics in typical residential wastewater and septage. A typical value of 0.076 kg BOD₅/person/day was utilized to estimate the organic loading from the residents and school population within Reston, through the piped collection system. Based on the projected year 20 population of 1,042 people on the piped collection system, an organic load of 79.2 kg BOD₅/day will be generated.

Truck hauled septage from surrounding rural septic tanks also needs to be considered as additional organic loading to the lagoon, as it will typically impact the peak daily Biochemical Oxygen Demand (BOD) loading. Using the rural housing population of 2.4 people/household and assuming each septic tank is 4,500 L and is pumped out annually, each septic tank pump out generates 4.15 kg BOD₅. The tank loading is based on 200 L/person/year of septage at 0.007 kg BOD₅/L and 0.000196 kg BOD₅/L of non-septage sewer. Therefore, the BOD production from each septic tank is $(200 \times 2.4 \times 0.007) + (4,500 - (200 \times 2.4)) \times 0.000196 = 4.15$ kg BOD₅.

Septage is permitted to be hauled to the lagoon over the time period of 135 days, as specified by Manitoba Conservation in the Environmental Licence. Within the 135 day hauling period, it is likely the majority of the hauling will occur during the normal Monday to Friday work week resulting in only 96 days effluent is hauled to the lagoon. Based on the rural population of 594 people, a housing density of 2.4 people/household and 96 hauling days, an average of 2.6 tanks need to be pumped out daily. With the projected year 20 rural population of 638 people, an average of 2.8 tanks would need to be pumped out daily in the 96 hauling days. Since only full tanks will be pumped out, the organic load will be based on three tank pump outs daily, resulting in a truck haul organic load of 12.5 kg BOD₅/day.

The RM of Pipestone will be responsible for limiting truck haul dumping to the lagoon from septic tanks to three tank loads per day. The estimated organic loading in the expanded lagoon is based on three tank loads per day. Based on the size of a typical septic hauling truck, this would be the equivalent of one truck load of septage per day. One of the concerns from Manitoba Conservation with truck hauling and septage dumping are the odours generated at the lagoon during disposal and therefore, this is accounted for in the primary cell sizing.

Manitoba provincial guidelines state the peak organic loading to the primary cell of the lagoon is limited to 56 kg BOD₅/ha/day. The 56 kg BOD₅/ha/day is based on the surface area of the primary cell(s) at a minimum height of 0.75 m from the cell floor.

The current total daily organic loading from piped sources and from truck haul loading of septage (considered peak day loading), is approximately 57.0 kg BOD₅/day. The daily loading is expected to increase to 91.6 kg BOD₅/day (peak day) in year 20, due to the projected increase in population. The existing lagoon primary cell has a total

organic capacity of 46.6 kg BOD₅/day. Table 1, in Appendix B, shows the current and projected year 20 organic loadings to the lagoon.

2.5.6.2 Hydraulic Loading

The hydraulic loading to the wastewater treatment lagoon is comprised of three waste streams: water usage, water treatment plant backwash water and infiltration. Manitoba Conservation requires a facultative lagoon to have sufficient storage for a 230 day period over the winter and spring months (November 1 to June 15).

The historical water usage, backwash water and lift station hour meters were reviewed between December 2011 and August 2013. A lift station pump test was performed on both existing Gorman Rupp pumps, model T6A3-B/F with 20 HP motor belt drive operating a 1,050 RPM on August 27, 2013. The pump test indicated that Pump 1 was operating at 19.8 L/s and Pump 2 was operating at 20.9 L/s.

Based on the hour meters on the lift station and a current population of 586 people (550 + 5 + 31), the average per capita daily flow to the lagoon between December 2011 and August 2013 was 484 L/p/day. Comparing the sewage flows to the water treatment plant flows and backwash flows, the average infiltration rate over that period was determined to be 200 L/p/day.

For lagoon hydraulic storage requirements, only the flow between November 1 and June 15 is of importance as it represents the lagoon storage period. During the lagoon storage period, the average day sewage flow to the lagoon was 371 L/person/day. During the same period, the average water usage at the water treatment plant was 254 L/person/day and the backwash was 18 L/person/day. Therefore, the balance of sewage flow of 99 L/person/day was considered to be infiltration.

In 2012, Genivar reported a per capita wastewater production to the lagoon of 388 L/person/day during the storage period, which is very similar to the results for the lift station test completed on August 27, 2013.

The summer flows to the lagoon are significantly higher, however since the lagoon can be discharged multiple times during the period from June 15 to November 1 as hydraulics require, the higher summer flows are not included in the lagoon sizing.

Based on the above per capita wastewater production rate of the 371 L/person/day, the current hydraulic loading to the lagoon from the piped collection system would be approximately 218 m³/day during the storage period. The projected hydraulic loading to the lagoon in year 20 from the piped collection system would be approximately 387 m³/day.

The additional volume of wastewater from truck hauled septage has not been included as the septage is not permitted to be hauled to the lagoon during the majority of the 230 day storage period.

The total hydraulic capacity of the lagoon would need to be 88,920 m³ over the required 230 day storage period to meet the year 20 demand. The existing lagoon has an overall hydraulic capacity of 48,973 m³. The existing and proposed lagoon cells would be sized for the projected year 20 hydraulic loading. Table 1, in Appendix B, shows the current and projected year 20 hydraulic loadings to the lagoon.

2.5.7 Existing Lagoon Assessment and Capacity

The organic and hydraulic storage capacities of the existing Reston lagoon were determined from a review of the Stantec 2002 “As Constructed” drawings of the lagoon, provided by the Manitoba Water Services Board. The requirements for lagoon loading and sizing were based on the Manitoba Conservation *Design Objectives for Standard Sewage Lagoons* (July, 1985).

2.5.7.1 Lagoon Assessment

The existing lagoon cells were visually assessed during the 2013 geotechnical investigation by JRCC. From the investigation, significant erosion was observed on the inner slope of the existing Storage Cells #1 and #2. Soil samples were taken from the existing lagoon dikes and were found to consist of medium plastic silty clays throughout and were deemed suitable for lagoon construction based on the results of the soils analysis. No significant concerns (discernible leakage or strong odours) were identified during the investigation, however a portion of the proposed expansion area was previously utilized for borrow soil in the original lagoon construction, and was therefore a low lying area had standing water. The perimeter and discharge ditch appeared to be in good condition and would likely be suitable for continued use after the expansion. The existing access road approach was constructed from granular material and appeared to be in good condition, along with the concrete spillway into the primary cell.

The following sections summarize the current organic and hydraulic capacities of the existing lagoon, based on the lagoon “as constructed” drawings. The information utilized for determining capacity included the inside slope of the primary and storage cell dikes that were constructed at 4H:1V; the operating depth of the lagoon cells (1.5 m); and the invert of the discharge pipe in the storage cell that is located at 0.3 m above the cell floor.

2.5.7.2 Existing Organic Capacity

Provincial guidelines stipulate that the organic loading rate of a lagoon must not exceed 56 kg BOD₅/ha/day in the primary cell. The effluent surface area at a 0.75 m depth in the primary cell is used to determine the treatment surface area. The existing lagoon primary cell currently has a surface area of 8,319 m² at a depth of

0.75 m, resulting in a total organic capacity of 46.6 kg BOD₅/day. Based on the estimated organic loading rate discussed above, the primary cell requires a minimum surface area of 16,366 m² at a depth of 0.75 m, in design year 20 for a total organic loading rate of 91.6 kg BOD₅/day. The existing lagoon organic capacity in the primary cell is not sufficient for the projected population in design year 20 and will require expansion.

2.5.7.3 Existing Hydraulic Storage Capacity

Provincial guidelines stipulate that the hydraulic storage capacity of a lagoon is determined from the volume of the top half of the primary cell and the storage cell(s) volume, between the discharge pipe invert and the maximum liquid level (1.5 m depth). The existing lagoon primary cell has a storage capacity of 6,677 m³, Storage Cell #1 has a capacity of 21,187 m³, and Storage Cell #2 has a capacity of 21,109 m³, resulting in an overall lagoon storage capacity of 48,973 m³. Based on the estimated year 20 hydraulic loading from the community, the lagoon requires a total storage volume of 88,920 m³ over the 230 day storage period. Therefore, the existing lagoon does not have sufficient hydraulic storage for the projected hydraulic loading from the service population and requires expansion.

2.5.8 Lagoon Sizing Requirements

As discussed above, the existing lagoon will not have sufficient capacity to meet the 20 year organic and hydraulic design loadings. Expansion of the primary and storage cell(s) is required to meet the future organic and hydraulic loading requirements.

Various options were considered for achieving the increased organic and hydraulic storage necessary, which included various combinations of converting existing cells and constructing new cells. However, through discussion with the Project Team the most feasible option considered was to expand the primary cell by converting the existing Storage Cell #1 into another primary cell, and constructing two new storage cells (see Plan L3 in Appendix D).

2.5.8.1 Design for Expansion of the Existing Lagoon

The expansion of the existing lagoon will include converting the existing Storage Cell #1 into an expanded primary cell through the removal of the intercell dike between the existing primary cell and Storage Cell #1. Based on this design, the expanded primary cell will have a surface area at a height of 0.75 m from the cell floor of approximately 26,354 m². This surface area will be capable of treating approximately 147.6 kg BOD₅/day, which is more than the projected year 20 organic loadings to the lagoon, therefore the primary cell will have additional buffering capacity.

Two new storage cells (Storage Cells #3 and #4) would be constructed to the southeast and east of the existing lagoon cells. Storage Cell #3 will be bordered to the east by the Manitoba Hydro overhead transmission line right of way, while Storage Cell #4 would be located to the east of the Hydro transmission line right of way (see

Plan L2 in Appendix C). The RM currently owns this parcel of land, therefore land purchase would not be required, however, due to the location of the Hydro transmission line, Storage Cell #4 cannot be located adjacent to the existing lagoon cells, therefore effluent from Storage Cell #2 will need to be piped approximately 150 m to Storage Cell #4 to utilize the additional storage capacity in this cell. Storage Cell #4 would have an independent discharge pipe and would discharge into the existing lagoon discharge route. Storage Cell #3 would work in combination with the existing Storage Cell #2, Storage Cell #4 and the primary cell, utilizing intercell pipes in the adjacent intercell dikes. Storage Cell #3 would not discharge directly, but would flow through Storage Cells #2 and #4 for discharging.

Storage Cells #3 and #4 would be constructed with inner slopes of 4H:1V, operating depths of 1.5 m and freeboard heights of 1.0 m to the top of dike. The top of dike elevation in Storage Cell #3 would match the elevation of the existing Storage Cell #2 top of dike. As the top of dike elevation in Storage Cell #1 (proposed primary cell) is approximately 1.0 m higher than the top of dike elevation in Storage Cell #2, the top of dike elevation in Storage Cell #3 would also be approximately 1.0 m below the top of dike elevation in Storage Cell #1. The top of dike elevation in Storage Cell #4 would be 2.0 m lower than the top of dike elevation in Storage Cell #3, to allow for gravity flow from Storage Cell #3 to Storage Cell #4 (see Plan L5 in Appendix D).

2.5.9 Topography and Geotechnical Investigation

An onsite geotechnical and topographical investigation was completed on September 19, 2013 and August 14, 2014 to determine the suitability of the site for the proposed upgrades and expansion of the existing lagoon.

2.5.9.1 Topography

A topographical survey of the test holes in the proposed lagoon expansion area was completed using GPS survey equipment. Based on site observations, the general area adjacent to the lagoon to the southeast was gently undulating grassland, with the exception of a low lying area used previously as a soil borrow area in the original lagoon construction. The land generally slopes towards the north and an elevation difference of approximately 2.0 m was observed from the south end of the expansion area to the north end over a distance of 120 m (a surface slope of approximately 1.7%). The previous borrow area is located in the central portion of this expansion area and has an elevation of approximately 2 to 3 m below the ground elevation in the remainder of the southeast expansion area.

The expansion area to the east of the Manitoba Hydro transmission lines was a mixture of undulating grassland and wetlands. The wetland areas are utilized as part of the lagoon discharge route, and contained areas of standing water and wetland vegetation (cattails and reeds), while the grassland area is proposed for the lagoon cell construction. The surface of the grassland area has a general slope towards the

east and has a maximum elevation difference of approximately 1.6 m across the proposed expansion area.

2.5.9.2 Past Geotechnical Data

Driller's Well Logs for the quarter section of the existing lagoon were not available, however, well logs for the surrounding quarter sections were reviewed for background soils and groundwater information (attached in Appendix C). These well logs indicated that the subsoil profile generally consists of surficial sand and silt, followed by till. The groundwater level was recorded at a depth of 6.4 m below the surface.

Reconnaissance Soils Survey data of the area indicate the soils at the existing lagoon site consist of Oxbow loam to heavy loam. Detailed soil survey information was not available for the project area. Based on agricultural capability mapping for the lagoon area, the lands are considered Class 1, which has no significant limitations on agricultural activities. According to the *Nutrient Management Regulations* under the *Water Protection Act*, lands with Agricultural Capability Classes 1, 2 or 3 are considered as Nutrient Management Zone N1 and do not have restrictions for the application of nutrients from a wastewater treatment lagoon.

A previous soils investigation was conducted by JRCC in 2000, for a proposed new lagoon site. These test holes were conducted in areas surrounding the lagoon, however not in the location of the current proposed expansion. This investigation described the soil profile as having a surficial layer of topsoil, followed by low plastic clay with silt and sand down to a depth of approximately 0.45 m. Underlying this was medium plastic clay with silt, sand and gravel down to the bottom of the test holes (7.6 m). Some test holes had observed layers of sand and till. Laboratory analysis indicated that the soils in the layer of medium plastic clay achieved a hydraulic conductivity of 1.4×10^{-7} cm/sec, which is slightly higher than the allowable rate. It was determined that obtaining a hydraulic conductivity of 1×10^{-7} cm/sec after reworking the soil would be difficult to achieve.

As part of a lagoon feasibility study in 2002, Stantec Consulting Ltd. also completed test holes in the area surrounding the existing lagoon site. The study indicated that the soil profile generally consisted of surficial topsoil, followed by medium plastic silty clay down to approximately 2.2 m, followed by medium plastic clay with silt down to the bottom of the test holes at 3.0 m. Results of hydraulic conductivity testing of the in situ silty clay material indicated that the soils would not be suitable for liner construction in an undisturbed in situ state. However the results of hydraulic conductivity testing on a reworked sample of the same silty clay material indicated that these soils would be suitable for liner construction when reworked and remolded.

2.5.9.3 Site Investigation

The onsite geotechnical investigation for the proposed lagoon upgrade and expansion was conducted on September 19, 2013 and August 14, 2014 by JRCC. A tracked drill rig was employed to conduct the test hole drilling under direct supervision by JRCC's field representative.

There were 18 test holes drilled during the geotechnical investigation, to a maximum depth of 6.0 m. The test holes were located in the existing lagoon dikes and in the land surrounding the existing lagoon cells to the south, southeast and east. The lands investigated were open grass lands, and were tested to determine whether the soils were suitable for use as a clay lagoon liner in an undisturbed state (in situ) or after reworking, and whether soils could be used for potential borrow material. Test hole locations are shown on Plan L1, attached in Appendix D.

The subsurface soil profile within each test hole was logged, water conditions were noted and representative soil samples were collected as the soils varied along the profile. The samples were visually field-classified and confirmed through laboratory analysis. Shelby tubes of undisturbed in situ soil were collected in various test holes and at depths appropriate for a lagoon liner. Bulk samples were also collected in various test holes and at various depths if testing of a reworked soil sample was deemed necessary. Following completion of drilling and prior to backfilling, an assessment of the short term groundwater conditions was completed by measuring the level of standing water in the test holes. Test holes in the lagoon dikes were backfilled with bentonite, while test holes in the expansion areas were backfilled with the auger cuttings.

Southeast Expansion Area

Based on the soils observed in the test holes, the general soil profile consisted of a thin layer of surficial black topsoil (approximately 0.075 m of organic soil with roots and 0.125 m to 0.225 m of clayey organic soil) followed by a layer of sand and sandy clay down to a depth of 0.5 m to 1.8 m below the surface. This sand layer was not present in TH1, but instead black, high plastic organic clay was located down to approximately 0.5 m below the surface. Below this was a layer of medium plastic, silty, sandy clay down to approximately 3.5 m - 4.8 m below the surface, followed by layers of clay till and silt till to the bottom of the test holes. The layer of medium plastic sandy clay was not present in TH3, but instead alternating layers of silt till and sand were observed. This test hole was located next to a former borrow pit, and may have been impacted by previous site activities, as the adjacent test holes (TH17 and TH18) did not show the same layering as TH3, but contained the same medium plastic sandy clay found in the majority of the test holes. Details of the soil profile in each test hole can be found in the Test Hole Logs attached in Appendix C. Refusal or bedrock was not encountered at any of the test holes.

Standing water was recorded in two of the test holes (TH1 and TH2) at depths ranging from 1.2 m to 4.3 m below the surface. Standing water in the test holes can vary based on static groundwater levels and on seasonal conditions, i.e. snowmelt and rainy seasons. Other assumptions relating to the groundwater elevation cannot be made at this time, as water levels will normally fluctuate seasonally.

Contractors should be made aware of the geotechnical conditions encountered onsite, as dewatering may be required during construction, depending on the depth of excavation determined during final design.

East Expansion Area

Based on the soils observed in the test holes, the general soil profile consisted of a thin layer of surficial topsoil (approximately 0.075 m of organic soil with roots and 0.125 m of silty or clayey organic soil) followed by a layer of silty clay and/or low plastic sandy clay. Below this was a layer of medium plastic brown sandy clay and below this (in TH10, TH12, TH15, TH17 and TH18) a layer of high plastic grey sandy clay down to the bottom of the test holes. The layer of medium plastic sandy clay was present in all of the test holes and had the greatest thickness in the soil profile. Details of the soil profile in each test hole can be found in the Test Hole Logs attached in Appendix C. Refusal or bedrock was not encountered at any of the test holes.

Standing water was recorded in two of the test holes (TH12 and TH16) at depths ranging from 4.1 m to 4.4 m below the surface. Standing water in the test holes can vary based on static groundwater levels and on seasonal conditions, i.e. snowmelt and rainy seasons. Other assumptions relating to the groundwater elevation cannot be made at this time, as water levels will normally fluctuate seasonally.

Contractors should be made aware of the geotechnical conditions encountered onsite, as dewatering and slope stabilization may be required during construction, depending on the depth of excavation determined during final design.

Existing Lagoon Dikes

Based on the soils observed in the test holes along the existing lagoon dikes, the general soil profile consisted of a layer of surficial black topsoil (approximately 0.1 m thick) followed by a layer of compacted, medium plastic clay down to approximately 1.4 m to 1.5 m below the top of dike. Below this was medium plastic, silty clay (likely native material) down to the bottom of the test holes. Refusal or bedrock was not encountered at any of the test holes. Standing water was recorded in three test holes (TH6, TH7 and TH8) at depths ranging from 1.7 m to 2.4 m below the surface.

Details of each test hole soil profile, including depth and description of each layer as well as comments on groundwater and test hole closure can be found in the Test Hole Logs attached in Appendix C.

2.5.9.4 Laboratory Analysis

Representative bagged soil samples from the proposed lagoon expansion areas and existing lagoon dikes, were submitted to The National Testing Laboratories Ltd. (NTL)/Stantec for testing and analysis. The following is a summary of the testing results, while details of NTL/Stantec analysis and testing results are attached in Appendix C.

Seven bagged samples were analyzed for the following:

- Atterberg Limits (plastic limit, liquid limit, and plasticity index, ASTM D4318)
- Soil Classification (ASTM D2487)
- Moisture Content (ASTM D2216)
- Particle Size Analysis (Hydrometer test, ASTM D422)
- Visual Classification.

In addition, two reworked samples and two in situ Shelby tube samples, from the proposed lagoon expansion area and the existing lagoon dikes, were tested for:

- Hydraulic Conductivity (ASTM D5084).

The seven bagged soil samples analyzed were from the following test holes:

- TH4 0.5 m – 4.8 m
- TH5 4.7 m – 6.0 m
- TH7 2.4 m – 3.0 m
- TH10 0 m – 0.2 m
- TH10 0.2 m – 4.5 m
- TH12 0.4 m – 2.5 m
- TH16 0.4 m – 1.4 m.

The Shelby tube samples analyzed were from the following test holes:

- TH7 2.4 m – 3.0 m
- TH9 0.6 m – 1.2 m.

The reworked sample analyzed was from the following test hole:

- TH4 0.5 m – 4.8 m
- TH10 0.2 m – 4.5 m.

The laboratory analysis of the bagged samples from the proposed expansion areas indicated that the soils consisted of CL - medium plastic silt and sandy clay. The

laboratory indicated that in general, homogeneous soils with a Plasticity Index greater than 25 and a clay content greater than 50% would typically be expected to achieve a hydraulic conductivity of 1×10^{-7} cm/sec or less. The Plasticity Index in the bagged samples ranged from 17 to 26 and the percentage of clay ranged from 26% to 36%. Based on these results none of the soils were considered suitable for use as a clay liner both in situ or when reworked and re-compacted, according to the NTL/Stantec soils analysis reports. The lab also noted that comments regarding the potential use of the material as a liner are based upon the soil being homogeneous with no preferential flow paths. It should be noted that estimating the hydraulic conductivity of a soil based upon classification test results (plasticity index and particle size analysis) alone might be misleading if the soil contains layers of sand, silt, or organic material.

The analysis of the sample from below the existing lagoon dike (TH7 2.4 m to 3.0 m) indicated that the soil was CL – medium plastic clayey, silty sand, with a Plasticity Index of 18 and a clay content of 27%.

The bagged sample representing the majority of the soils in the expansion areas were considered unsuitable for use as a clay liner in an in situ (undisturbed) state or when reworked and compacted, according to the NTL/Stantec soils analysis reports. Bulk samples of this soil material were submitted to the laboratory for permeability testing on reworked samples under optimal moisture conditions. The sample from TH4 was reworked to 97% of the Standard Proctor Density at the optimum moisture content (17.0%) and obtained a hydraulic conductivity of 5.5×10^{-9} cm/sec. The sample from TH10 was reworked to 96% of the Standard Proctor Density at the optimum moisture content (15.0%) and obtained a hydraulic conductivity of 1.2×10^{-8} cm/sec. A permeability test of reworked soils in the laboratory is expected to be an accurate representation of reworking soils during construction and is therefore used to estimate the hydraulic conductivity in a liner of reworked soil material. The results of the reworked permeability testing for both samples were within the Manitoba Conservation requirements for a clay lined lagoon. These results contradict the results of analysis conducted on the bagged soil samples obtained from the same soil layers which were initially deemed unsuitable for use as a clay liner in an in situ state or when reworked and compacted. It is expected that the reworked hydraulic conductivity testing is a more accurate determination of the suitability of soils for use as a potential soil liner than the analysis of disturbed bag sample, therefore the results of the reworked hydraulic conductivity analysis should ultimately determine suitability of the soils for liner construction.

The two Shelby tube samples submitted to NTL/Stantec were located in the layer of native medium plastic clayey silt (TH7 2.4 m to 3.0 m), and in the compacted medium plastic silty clay from the lagoon dike (TH9 0.6 m to 1.2 m). These samples were tested to determine the in situ hydraulic conductivity for comments on suitability as an in situ lagoon liner. An examination of the samples was conducted

after extraction from the Shelby tubes and the samples appeared homogeneous, therefore a representative portion was selected for analysis. The in situ samples achieved hydraulic conductivities of 1.3×10^{-6} cm/sec [TH7], which is outside the requirements for hydraulic conductivity in clay lagoon liners, and 1.9×10^{-8} cm/sec [TH9], which is within the requirements for hydraulic conductivity, as discussed in Section 2.5.10 below. This confirmed the laboratory estimation that the soil sample from TH7 was not suitable for use as an in situ lagoon liner.

2.5.10 Design Guidelines

Manitoba Conservation guidelines require that a standard wastewater lagoon clay liner be a minimum of 1.0 m in thickness and have a hydraulic conductivity (i.e. the potential rate of fluid movement through the soil) of 1×10^{-7} cm/sec or less. This low permeability rate is to protect the underlying groundwater from lagoon effluent seepage.

2.5.11 Typical Lagoon Liner Construction Options

The liner of a lagoon can be constructed using in situ (undisturbed native) soils, if the soils can consistently achieve a hydraulic conductivity of 1×10^{-7} cm/sec or less in their in situ state. If in situ soils cannot achieve the required hydraulic conductivity, the lagoon liner can be constructed by excavating and re-compacting suitable clay soils to form the liner.

If the clay content of the soils is so low that even when excavated and re-compacted, the soils cannot consistently achieve a hydraulic conductivity of 1×10^{-7} cm/sec, a liner constructed of high plastic clay from a borrow pit, or a synthetic geomembrane liner would be required.

2.5.12 Proposed Lagoon Expansion Liner Design

Based on the field observations and results of the in situ and reworked permeability testing, the medium plastic soils observed at the site are likely to consistently achieve hydraulic conductivities of less than 1×10^{-7} cm/sec after reworking and compacting. The suitable soil layer for construction of the horizontal and vertical lagoon cell liner was estimated from 0.2 m - 0.3 m (top of layer), down to 6.0 m (bottom of layer) below the surface. As unsuitable soils were also encountered in some test holes during the field testing, it is expected that unsuitable soil material will likely be encountered during the lagoon expansion construction works and that this soil material will require removal and replacement with suitable compacted material. The reworked soils forming the horizontal (lagoon floor) and vertical lagoon liner (cut-off wall) is to be constructed to a minimum thickness of 1.0 m. The vertical cut-off wall is recommended to have a minimum thickness of 3.0 m, to accommodate typical soil compaction equipment and vehicle access on the top of the dikes.

There is always a risk associated with utilizing excavated soils for the construction of a lagoon liner after reworking and re-compacting. The soil analysis results of bagged samples identified poor soil properties for a lagoon liner, however hydraulic conductivity testing suggests that the soils would be suitable for the lagoon liner. Therefore, soils at this site are considered marginal but can be utilized in liner construction. While this risk is estimated to be low at the proposed

expansion area, based on the results of the hydraulic conductivity testing, it is possible that the soil liner may not meet Manitoba Conservation requirements after construction. Any unsuitable material (silt, sand or stone seams) discovered during construction would need to be removed from the lagoon liners to prevent the possibility of preferential flow paths through the liners.

2.5.13 Review of Regulatory Requirements

The Province of Manitoba *Design Objectives for Standard Sewage Lagoons* (1985) was used as a guideline in the layout and design of the lagoon expansion. The provincial siting requirements are described in Section 2.6.2 above.

2.5.13.1 Organic Loading

Although a lagoon operates at various organic efficiencies throughout the year, an average organic treatment rate of 56 kg BOD₅/ha/day at a depth of 0.75 m in the primary cell has been utilized.

2.5.13.2 Hydraulic Loading

The lagoon cannot be discharged between November 1 and June 15 (230 day winter and spring storage period) per current Manitoba Conservation requirements. Therefore, the lagoon must have the storage capacity for this time period based upon half the volume of the primary cell and the storage cell(s) volume from the invert of the discharge pipe to the maximum liquid level.

2.5.13.3 Lagoon Liner

Sewage lagoons are to be designed and constructed such that the interior surface of the proposed lagoon is underlain by soil with a thickness of at least one metre and of having a hydraulic conductivity of 1×10^{-7} cm/sec or less. In the absence of soils with a hydraulic conductivity of 1×10^{-7} cm/sec or less, the interior surfaces of a lagoon could be lined with a synthetic liner.

2.5.13.4 Effluent Quality Requirements

Any new or expanding wastewater treatment lagoons are required to meet the Manitoba *Water Quality Standards, Objectives and Guidelines - Tier 1 Water Quality Standards* at a minimum, along with the *Federal Wastewater Systems Effluent Regulations*, for discharged effluent. The effluent requirements for the Reston wastewater treatment lagoon, at a minimum, would be:

- Fecal coliforms of 200/100 ml or less, or E. coli of 200/100 ml or less
- BOD of 25 mg/L or less
- CBOD of 25 mg/L or less
- TSS of 25 mg/L or less
- Total residual chlorine of 0.02 mg/L or less

- Un-ionized ammonia (as N) of 1.25 mg/L or less, at 15°C
- 1 mg/L Total Phosphorus or demonstrated nutrient reduction strategy.

Additional effluent parameters may be required as part of the Environment Act Licence, to be determined by Manitoba Conservation.

2.5.14 Nutrient Management Plan

The Manitoba *Water Quality Standards, Objectives, and Guidelines*, 2011, outline the nutrient reduction requirements for effluent in all new, expanding or modified wastewater treatment facilities. The regulations include province wide standards for biological reduction, suspended solids reduction, phosphorus reduction and where site-specific conditions warrant, nitrogen reduction. The Federal *Wastewater Systems Effluent Regulations*, 2012, outline the limits on un-ionized ammonia concentration in the effluent.

A 1.0 mg/L phosphorus limit applies for effluent upon discharge, with the exception being small wastewater treatment facilities that serve less than 2,000 equivalent people, which have the option of implementing a nutrient reduction strategy instead of the 1.0 mg/L phosphorus limit. Nitrogen reduction to 15 mg/L is required on a site-specific basis depending on the receiving environment for new and expanding wastewater treatment facilities serving more than 10,000 equivalent people. The Reston lagoon would not be required to adhere to a nitrogen limit of 15 mg/L, based on the service population. A limit of 1.25 mg/L of un-ionized ammonia applies to all lagoons, however the un-ionized portion of ammonia is pH and temperature dependent, and will increase with higher temperatures and pH. Typically this ammonia limit can be met by regular lagoon operations such as discharging effluent in the spring and fall and not during the warmest period of the summer. Algae blooms in a lagoon can trigger an increase in pH and un-ionized ammonia, however these algae blooms also typically occur during the warmest period of the summer, and so the most simple solution would be to wait until the water temperatures drop in the fall before discharging.

Nutrient reduction strategies include, but are not limited to, effluent irrigation, trickle discharge or constructed wetlands. The guidelines also set the discharge requirements for fecal coliforms at 200 organisms/100 ml sample, Total Suspended Solids at 25 mg/L and the Biochemical Oxygen Demand at 25 mg/L [facilities with ammonia or total nitrogen limits have a Carbonaceous Biochemical Oxygen Demand limit of 25 mg/L].

As the original lagoon was designed prior to these guidelines being instituted, the following options were considered to address nutrient management, with particular emphasis on phosphorus reduction for the Reston lagoon expansion.

Sewage Treatment Technology

Sewage treatment technology, such as chemical addition and filtration systems require the effluent to be pumped from the storage cell through a filtration system, before being discharged from the lagoon. The backwash effluent from the filtration system is discharged into the primary

cell. This level of treatment is quite costly and requires regular operation and maintenance. Equipment and housing is required along with electrical power source at the site. It is not a preferred option for the Reston lagoon due to the higher capital cost and operating and maintenance costs.

Chemical Treatment

This option involves application of chemicals such as alum to wastewater in the storage cell to reduce the level of phosphorus in the treated effluent. The alum is broadcast onto the surface of the storage cell utilizing a gas driven pump and spray system from the top of the dike, or from a boat on the surface of the storage cell. The alum produces a chemical reaction with the phosphorus causing a pin floc, which settles to the bottom of the cell. The effluent can then be discharged from the storage cell with a reduced level of phosphorus. This option could possibly be used for the Reston lagoon to obtain a phosphorus upper limit of 1.0 mg/L (if required). The phosphorus level in the treated effluent must be tested prior to discharge and if the phosphorous is not at or below 1.0 mg/L, additional spreading of the alum on the storage cell surface may have to be repeated, if this method is utilized.

Constructed or Natural Wetlands

Constructed wetlands or natural wetlands can be used to polish treated effluent from a lagoon, and have the potential to provide biological and nutrient reduction. Constructing engineered wetlands can require large land areas and add significant construction costs to the project that can make the option unfeasible. However if natural wetlands exist in the vicinity of the lagoon discharge, they can potentially be utilized for enhanced biological and nutrient reduction in the discharge route. Currently at the Reston lagoon site, the treated effluent does in fact discharge into a natural wetland area, which then flows into a surface drain and eventually into a creek. It is expected that this natural wetland area does enhance biological and nutrient reduction after discharge.

Trickle Discharge

A slower discharge of effluent is expected to increase opportunity for nutrients to be taken up by growing plants and permeable soils along the drainage route, which is a means of reducing phosphorus concentration in the treated effluent. The proposed drainage route from the lagoon is through a natural wetland and into a natural drain for approximately 10 km prior to entering Stony Creek.

The maximum discharge volume from the lagoon would be 68,790 m³ (total available volume in the storage cells). Typically the hydraulic storage volume of the primary cell is not included in the discharge volume, as the intercell valve between the primary and storage cells is closed during lagoon discharge, to prevent untreated effluent in the primary cell from being discharged.

With the arrangement of the proposed storage cells at the Reston lagoon there will be opportunity to isolate each storage cell, therefore at the end of the 230 day storage period, only Storage Cell #2 would be discharged over a two week period, while the other cells would continue

to receive influent. After the two week discharge period, Storage Cell #2 would receive influent again and Storage Cells #3 and #4 would be isolated for a two week discharge period. This process would not have an impact on the lagoon cell freeboard until design year 16, based on the projected population growth rate. At that time the lagoon hydraulic loading could be re-evaluated based on the actual service population. The discharge rate from Storage Cell #2 over a two week period would be approximately 17.3 L/sec, and the discharge rate of the combined volume in Storage Cells #3 and #4 over a two week period would be approximately 39.5 L/sec. An additional week was also included in the isolation period of the storage cells for lagoon effluent testing. This process would require careful operation due to the timing and varied elevations of the cells.

Based on the slower discharge rate from the lagoon and the length of discharge route, it is expected that natural uptake of nutrients by the plants and soils will occur prior to the effluent reaching Stony Creek.

Public Awareness

In conjunction with nutrient reduction methods described above, preventative measures can also be taken to reduce nutrients in the wastewater influent. As the majority of the influent to the Reston lagoon would be residential in nature, the RM of Pipestone is encouraged to inform residents and schools in Reston of nutrient reducing strategies, such as using non-phosphate based soap and cleaning products for domestic use. This would reduce the amount of phosphorus being released into the lagoon and reduce the requirements for treatment.

Proposed Option

As the population being serviced by the Reston lagoon is less than 2,000 people, a nutrient reduction strategy is proposed, as opposed to a phosphorus limit of 1.0 mg/L prior to discharge. The proposed option to meet the nutrient reduction requirements in a new environmental licence would be to utilize a trickle discharge from the storage cells and continue to utilize the natural wetlands to the east of the lagoon cells for additional treatment. In addition, the RM of Pipestone will be encouraged to notify residents in Reston about the importance of nutrient source reduction in their homes.

2.5.15 Upgraded Lagoon Design Requirements

In the construction of the new lagoon Storage Cells (#3 and #4), the cells would be clay-lined with 4H:1V slopes on the interior dikes, would utilize a 0.3 m invert height above the cell bottom and have a 1.0 m freeboard [see Plan L5 in Appendix D]. A storage period of 230 days was utilized for sizing, per current Manitoba Conservation requirements.

2.5.15.1 Primary Cell

As described above, the existing Storage Cell #1 would be converted to a primary cell by removing the intercell dike between the existing primary cell and Storage Cell #1, as shown on the plans. The cell floor under the portion of dike removed will also be

reworked to form a suitable horizontal liner. Based on this design the new primary cell would have a surface area at a height of 0.75 m from the cell floor, of approximately 25,646 m². This surface area would be capable of treating the projected year 20 organic loadings to the lagoon and have additional buffering capacity. At the time of the original lagoon construction, Storage Cell #1 was constructed with the cell floor elevation 0.1 m higher than the primary cell floor, therefore in the new combined primary cell the south half of the cell would continue to have a cell floor elevation 0.1 m higher than the north half. In maintaining a minimum freeboard of 1.0 m, the south half of the primary cell would have a maximum operating depth of 1.4 m, while the north half of the primary cell would have an operating depth of 1.5 m. This variance in operating depth would not impact the organic loading capacity of the primary cell, but it would have an impact on the overall hydraulic storage capacity.

2.5.15.2 Storage Cells

The original design of the existing Storage Cell #2 would remain unaltered through the proposed upgrades. Storage Cell #2 has an existing flat bottom area of approximately 15,758 m², and a hydraulic storage capacity (above pipe invert) of approximately 21,108 m³. Proposed Storage Cell #3 would have a flat bottom area of approximately 22,310 m², and a hydraulic storage capacity (above pipe invert) of approximately 29,495 m³. Proposed Storage Cell #4 would have a flat bottom area of approximately 13,690 m², and a hydraulic storage capacity (above pipe invert) of approximately 18,520 m³. The following table summarizes the storage cell sizes and hydraulic capacities:

Cell	Approximate Flat Bottom Area	Approximate Hydraulic Storage Capacity (Above Pipe Invert)
Existing Storage Cell #2	15,758 m ²	21,108 m ³
Proposed Storage Cell #3	22,310 m ²	29,495 m ³
Proposed Storage Cell #4	13,690 m ²	18,520 m ³

With the storage capacity available in the top 0.75 m of the proposed primary cell (19,845 m³), the total hydraulic storage available would be approximately 88,968 m³. The total storage volume would be sufficient to design year 20, over the 230 day storage period.

2.5.15.3 Cell Repairs

As observed during the site investigation significant erosion had occurred on the inner slopes of existing Storage Cells #1 and #2. As these cells were constructed with a clay liner along the inner slopes, erosion can potentially impact the lagoon liner effectiveness, as the original designed liner thickness may not be maintained. From the test holes taken in the centre of the lagoon dikes, it appears that the material used in the dike construction is suitable and would meet the provincial requirements

for a lagoon liner. Laboratory testing of these soils confirmed the suitability of the lagoon liner material in the centre of the dikes. The liner can therefore be considered in the core of the dike and not only on the inner slopes, as shown in the “as built” drawings.

As part of the lagoon upgrading the inner slopes of these two cells would be repaired along the east and south dikes, utilizing compacted sandy clay material from the site excavation. As the erosion is the result of wave action and the prevailing winds are typically from the north and west, the slopes that are most susceptible would be the south and east inner slopes. Installation of rip rap stone along the east and south inner slopes, from approximately 0.6 m above and 0.6 m below the high water mark (1.5 m above the cell floor), is proposed.

2.5.15.4 Summary of Selected Design Criteria

A list of design parameters pertinent to the Reston lagoon upgrade and expansion is provided below:

- A 20 year design period
- A combined equivalent population of 1,042 people from the piped collection system in Reston
- A total rural population of 638 people utilizing truck hauling to the lagoon
- A storage period of 230 days
- A total daily organic loading rate of 91.6.3 kg BOD₅/day, which includes three septic tank pump outs (one truck load) of septage per day
- A total projected hydraulic loading of 88,920 m³ during the 230 day storage period
- Use of the existing access road, truck turnaround and spillway for trucked effluent
- Use of the existing forcemain into the primary cell
- Removal of the intercell dike between the existing primary cell and Storage Cell #1 to form an expanded primary cell
- Utilize reworked and compacted clay soils on the cell floor beneath the removed portion of intercell dike, to provide a suitable horizontal liner
- Expanded primary cell will have a surface area of 25,646 m² at a height of 0.75 m from the cell floor, and an organic loading capacity of 147.6 kg BOD₅/day
- Construct two new Storage Cells (Storage Cells #3 and #4) to the southeast and east of the existing lagoon cells
- An operating depth in Storage Cells #3 and #4 of 1.5 m and a freeboard height of 1.0 m from the maximum liquid level to the top of dike
- A total usable hydraulic storage volume of 88,968 m³

- Install an intercell pipe between the expanded primary cell and Storage Cell #3
- Install an intercell pipe between Storage Cell #2 and Storage Cell #3
- Install an intercell pipe between Storage Cell #3 and Storage Cell #4
- Utilize existing discharge pipe invert of 0.3 m above the floor of the existing Storage Cell #2
- Install a discharge pipe through the east dike of Storage Cell #4
- Utilize the existing discharge route
- Utilize reworked and compacted clay soils on site for the horizontal and vertical liners in Storage Cells #3 and #4
- Construct the horizontal cell floor liner to a minimum thickness of 1.0 m
- Construct the vertical cut off wall to a minimum thickness of 3.0 m
- A slope of 4H:1V for the inner and outer dike slopes of the Storage Cells #3 and #4
- Install a barbed fence around the perimeter of Storage Cell #3 to connect with the existing lagoon perimeter fencing
- Install a barbed wire fence around the perimeter of Storage Cell #4
- Construct a perimeter ditch around the toe of Storage Cell #3 to connect with existing lagoon perimeter ditching
- Install rip rap stone along the inside slope of Storage Cells #3 and #4
- Install rip rap stone along the south and east inner slopes of the existing Storage Cell #2 and Storage Cell #1 to control future erosion.

2.5.16 Lagoon Construction Details

Conceptual design plans (Plans L1 to L6) for the lagoon expansion and upgrading are provided in Appendix D.

Storage Cells #3 and #4 would be excavated and the dikes constructed with excavated and compacted soil from the expansion cell areas and borrow area. A 3.0 m wide vertical cut-off wall would be extended 1.0 m into the reworked and compacted horizontal liner. The inner and outer dike slopes would be constructed at 4H:1V. Rip rap stone would be placed 0.6 m above to 0.6 m below the high water mark along the inner slopes of Storage Cells #3 and #4 to minimize erosion (see Plan L5 in Appendix D). All organic topsoil would be removed to a depth of approximately 0.2 m - 0.3 m from the expansion areas. The lagoon horizontal and vertical liners would be compacted to a minimum Standard Proctor Density of 98% and kept at a limited range of moisture content, near the ideal moisture content during construction. The material shall not be so wet nor so dry that compaction equipment cannot compact the fill into a homogeneous mass. Material too wet shall be dried or wasted and material too dry shall be wetted. Dike and soil liner

material, should be compacted with a minimum of eight passes of a sheepsfoot roller on 150 mm compacted lifts.

Storage Cells #3 and #4 would be constructed with a proposed height of 2.5 m from the cell floor to the top of dike. An intercell pipe would be extended through the dikes between the expanded primary cell and the west dike of Storage Cell #3. An intercell pipe would also be extended through the dikes between Storage Cell #2 and the north dike of Storage Cell #3. An intercell pipe would be extended through the east dike of Storage Cell #3 and into Storage Cell #4, approximately 150 m to the east. Valves would be placed in the dikes for the newly installed intercell pipes (see Plan L6 in Appendix D). The dike tops surrounding Storage Cells #3 and #4 would be constructed with a width of 3.0 m to accommodate vehicle access. A barbed wire perimeter fence would be installed around the toe of Storage Cells #3 and #4 (see Plan L6 in Appendix D). The fencing around Storage Cell #3 would tie into the existing barbed wire fencing, while the fencing around Storage Cell #4 would be independent and have a separate access gate for maintenance equipment. The top of dike and outside slopes of Storage Cells #3 and #4 would be seeded with grass upon completion of construction to prevent soil erosion.

Perimeter ditches would be constructed around the outside toe of Storage Cell #3 and would connect with the existing lagoon perimeter ditch. A perimeter ditch would not be constructed around the outside toe of Storage Cell #4, but instead the ground would be sloped into the surrounding wetland areas. The outer slope and perimeter drainage system would prevent surface drainage from entering into the lagoon and the ponding of surface drainage around the perimeter toe of the lagoon cells.

The intercell dike between the existing primary cell and the existing Storage Cell #1 would be removed to expand the primary cell. This excess soil material would be stockpiled and used to backfill borrow areas or low lying areas requiring fill. The cell floor below the removed section of dike would be reworked and compacted to a thickness of 1 m, to provide a suitable floor liner.

2.5.17 Decommissioning

The existing lagoon cells will continue to be utilized after the upgrade is completed. Lagoon decommissioning will be considered and examined by the proponent after design year 20 has passed, or at the time a new replacement lagoon is proposed.

Decommissioning would typically require a decommissioning plan submitted to Manitoba Conservation, discussing the removal of liquid and sludge, possible removal of lagoon dikes, site grading and seeding, and future use of the lands.

2.5.18 Lagoon Maintenance

Maintenance of the expanded and upgraded lagoon will include:

- Maintaining the fencing and gate
- Ensuring gate is locked

- Monitoring the truck hauled septage dumping into the lagoon primary cell
- Opening and closing the intercell and discharge piping valves when required
- Maintaining grass cover on dikes to a height of no more than 0.3 m in height
- Maintaining a program to prevent and remove burrowing animals
- Maintaining rip rap at location of lagoon discharge and on inner slopes to prevent erosion of soils
- Monitoring liquid level of lagoon cells
- Sampling lagoon effluent prior to and during discharge period, in accordance with the lagoon effluent monitoring plan
- Discharging lagoon cells in the correct order and for the proper amount of time
- Maintaining records of discharge events and water quality testing.

3.0 POTENTIAL ENVIRONMENTAL IMPACTS

The biophysical and socioeconomic environment as related to the development, and potential impacts of the development on the environment.

3.1 Releases to Air, Water, Land

3.1.1 Air

In general, nuisance odours occur in facultative lagoons that are improperly sized and organically overloaded. Odours are also generated under anaerobic conditions, which are common at the bottom of facultative lagoons. During the summer, the lagoon would be aerobic at the surface, facultative at the centre and anaerobic at the bottom. Minimal to no treatment would occur in the winter due to the ice cover on the surface; the treatment process would predominantly be anaerobic during winter and would also include solids settling. Therefore, the lagoon may generate some odours for a short time each spring during the thawing or turn-over period when water temperature inversion causes turbulence in the lagoon cells and gases produced from the anaerobic treatment process are brought to the surface. Prevailing winds in the area can carry odours if the area is exposed and wind breaks are not utilized around the lagoon cells. This can cause a nuisance to nearby residents.

There is also a potential for greenhouse gas emissions during construction works from heavy equipment and transport vehicles. Impacts from dust generation are not expected as the construction area will meet the minimal setback distances from residences.

3.1.2 Water

Pollutants that may be released into surface and ground water during the operation of the lagoon include coliforms, organic wastes, suspended solids, nutrients and other materials that are typically disposed of into the sewer system in a residential community. Pollutants in the wastewater produced by the service population are expected to be residential in nature.

Pollutants that have a potential to be released into the surface or ground water during the lagoon upgrade and expansion construction activities, include petroleum hydrocarbons (PHCs) from heavy equipment and sediments from soil erosion.

Surface Water

Surface water may be impacted if the wastewater is not sufficiently treated and subsequently discharged from the lagoon into a surface water body. Effluent discharged from the lagoon would eventually reach Stony Creek and Maple Lake. There is also potential to impact surface water via sedimentation in the discharge route during construction.

The discharge from the lagoon should not cause or contribute to flooding in or along the drainage route. There is no potential to impact the navigation of surface waters as a result of the lagoon

project, as the proposed drainage route is not in the immediate vicinity of a navigable body of water.

Groundwater

There is a potential for groundwater impacts if wastewater leaks/seeps through the lagoon liner or forcemain pipe and into the groundwater below. There is also a potential for groundwater impacts from equipment leaks or fuel spills during construction.

3.1.3 Land

The landscape would be altered by construction of the lagoon dikes and perimeter ditching. Fencing would be installed around the perimeter of the new lagoon cells. Disturbed areas can be impacted through soil erosion if not covered or re-vegetated.

Pollutants that may be released to the land are typically petroleum hydrocarbons (PHCs), which could be released during construction activities. Equipment leaks or re-fuelling incidences could result in an impact to the land during construction activities.

3.2 Wildlife

The proposed lagoon site is located in the “Aspen Parkland” Ecoregion of Canada. Characteristic wildlife includes white-tailed deer, coyote, snowshoe hare, cottontail, red fox, northern pocket gopher, and ground squirrel. Bird species include waterfowl, sharp-tailed grouse and black-billed magpie.

The typical concern on any construction project is that wildlife species would be displaced through the construction works. However, from observations made during the site investigation it is unlikely that the construction works will have any significant impact on wildlife in the area. In addition, the Manitoba Conservation Wildlife and Ecosystem Protection Branch was contacted regarding the proposed lagoon upgrade project and they indicated that there were no occurrences of species at risk at the proposed site in the database. Refer to the January 2, 2014 email correspondence, attached in Appendix B.

3.3 Fisheries

The typical concerns for impacts to fish and fish habitat are from sediments released during construction and from untreated lagoon effluent discharges into surface water utilized by fish species. These impacts could include the reduction of water quality or physical disturbances which would create an unfavorable environment for fish or fish eggs.

However, impacts to fish species along the discharge route are unlikely as the lagoon effluent would not be discharged directly into a body of surface water with known fish species. In fact the drainage route travels for approximately 10 km prior to reaching a body of surface water (Stony Creek) with known fish species. It is expected that nutrients will be absorbed into the soils and taken up by the surrounding vegetation in and along the discharge route prior to reaching Stony Creek. Lagoon discharge would only occur after the spring fish spawning period has normally occurred, and treated effluent requirements of the environmental licence would be met prior to the effluent reaching Stony Creek.

3.4 Forestry

There are no potential impacts to forestry as the area of the lagoon expansion has been previously cleared and no potential forestry areas would be impacted.

3.5 Vegetation

Characteristic vegetation in the “Aspen Parkland” Ecoregion is classified as being a transitional grassland ecoclimate, with a significant degree of farmland. The native landscape is characterized by trembling aspen, oak groves and mixed tall shrubs and intermittent fescue grasslands.

There is a potential concern for the removal of vegetative species through the construction works, however Manitoba Conservation Wildlife and Ecosystem Protection Branch were contacted regarding occurrences of rare or endangered species in their database at the proposed lagoon expansion site. The Branch indicated that there were no occurrences of any species at risk at the proposed site in the provincial database. Refer to Manitoba Conservation Wildlife and Ecosystem Protection Branch email correspondence dated January 2, 2014, attached in Appendix B.

3.6 Noise Impacts

There is a potential for noise impacts in the immediate area of expansion due to the heavy equipment utilized during construction. Other than maintenance vehicles (for lagoon effluent sampling or mowing grass) or septic hauling trucks, the operation of the lagoon itself, will not have a potential for noise impacts.

3.7 Health and Safety

There is a potential for impacts to the health and safety of workers and the public during the construction works, as heavy equipment will be utilized on site.

3.8 Heritage Resources

The RM of Pipestone was not aware of any historic or heritage resources located at the proposed lagoon expansion site. The Manitoba Historic Resources Branch was contacted regarding the proposed site. The Historic Resources Branch indicated that the potential to impact significant heritage resources is low and that they have no concerns with the project. Refer to the Manitoba Historic Resources Branch January 13, 2014 email correspondence, attached in Appendix B.

3.9 Socio-Economic Implications

The lagoon expansion is not expected to have adverse socio-economic impacts. In fact, construction related economic activity should have a positive economic impact on the community, along with the increased wastewater storage capacity, which will encourage continued growth in the community.

3.10 Aesthetics

The lagoon expansion is not expected to have adverse impacts on the general aesthetics of the area, as the lagoon construction would occur adjacent to the existing lagoon cells, on land which does not have any designated aesthetic qualities.

4.0 MANAGEMENT PRACTICE

Proposed environmental management practices to be employed to prevent or mitigate adverse implications from the impacts identified above.

4.1 Mitigation of Impacts to Air

To reduce the potential for odour nuisance in the nearby community, the primary cell will be sized greater than the requirements for projected year 20 organic loadings from the service population. This takes into consideration the maximum allowable organic loading rate of 56 kg BOD₅/ha/day into the lagoon primary cell, which impacts the odours generated from a wastewater treatment lagoon peak day organic loading during septic truck dumping. Therefore, nuisance odours as a result of organic over-loading are not expected.

Although the lagoon would likely generate some odours for a short time each spring, during the thawing or turn-over period, prevailing (i.e. northwesterly) winds should not cause odours to drift toward the community, as the lagoon is located southwest of the community. Furthermore, the proposed lagoon expansion would be located a minimum of 300 metres from the nearest resident and 460 metres from the centre of the community.

Emissions from construction equipment and transport vehicles will be controlled through regular maintenance by the contractor, and will meet all provincial and local standards. Dust suppression methods (i.e. water spraying) will be utilized at the construction site if dry conditions create excessive dust through construction activities and transport, and becomes a nuisance to nearby residents. Due to the setback distance from residences, it is unlikely that dust will have any impact on the community or nearby residents.

4.2 Mitigation of Impacts to Water

Surface Water

Impacts to surface waters from discharge of lagoon effluent are not expected, as the lagoon effluent would be treated to the *Tier 1 Manitoba Water Quality Standards, Objectives and Guidelines*, and the *Federal Wastewater Systems Regulations* prior to discharge. In addition, measures such as a trickle discharge, natural wetlands and the length of the discharge route would be utilized to further reduce nutrient loading to downstream surface waters.

Erosion from any excess material stockpiles would be prevented by the use of silt fencing at drainage locations and by either covering any bare soil stockpiles or seeding with grass. Silt fencing would be installed in the perimeter ditching and alongside the wetland area during construction and should remain in place until grass growth is established. Perimeter ditch slopes would be seeded with grass to help control erosion and sediment entry into the discharge route. Disturbance of the soils adjacent to the perimeter ditches, discharge route and existing wetland area would be minimized during construction.

To minimize impacts from construction equipment on surface waters, the construction specifications should outline to the contractor the requirements for handling and storage of fuels and hazardous

materials during construction, as per federal and provincial regulations. The specification should state wording similar to the following:

- Diesel or gasoline should be stored in double walled tanks or have containment dikes around fuel containers for volumes greater than 68.2 L (15 gallons) or in compliance with provincial regulations
- Clean up material should be available at the site, consisting of a minimum of 25 kg of suitable commercial sorbent, 30 m² of 6 mil PVC, and an empty fuel barrel for spill collection and disposal
- Fuel storage and hazardous material areas established for project construction should be located a minimum of 100 m from a water body, and comply with provincial regulations
- Waste hazardous materials from construction activities and equipment must be properly collected and disposed of in compliance with provincial regulations
- Hazardous material handling and storage are to follow all provincial and federal regulations including WHMIS and spill containment requirements
- In the event of spills or leaks of fuels and hazardous materials, the contractor or operator should notify the project engineer and provincial authorities.

The specifications should state that when working near water with construction equipment:

- Construction equipment is to be properly maintained to prevent leaks and spills of fuels, lubricants, hydraulic fluids or coolants
- There can be no re-fueling or servicing of construction equipment within 100 m of a water body.

There would be no impacts to navigation as a result of the lagoon project, as the discharge route is not a navigable body of water. If flooding occurs along the drainage route, the RM must not discharge the lagoon. The discharge should not cause or contribute to flooding in or along the drainage route. Overland flooding around the lagoon would be unlikely as there are no significant bodies of water in the vicinity of the lagoon.

Groundwater

Seepage of effluent from the lagoon is unlikely to affect groundwater as the new lagoon storage cell would utilize a re-worked clay liner, having a minimum thickness of 1.0 m and a hydraulic conductivity of 1×10^{-7} cm/sec or less, as required by Manitoba Conservation.

Mitigation of potential impacts to groundwater during the lagoon construction activities from fuel handling, equipment leaks or fuel spills, would follow the same procedures as described above for surface waters.

4.3 Mitigation of Impacts to Land

As the lagoon would be lined with a re-worked clay liner, seepage to the surrounding land is expected to be negligible. To minimize the potential for the release of Petroleum Hydrocarbon (PHC) pollutants into the soil, the mitigation measures described in Section 4.2 above outlining fuel handling procedures should be followed.

To minimize the potential for slope erosion, the outside slopes of the newly constructed dikes would be constructed with a 4H:1V slope and the dike tops and outside slopes would be seeded with grass. The location of the discharge outlet would be covered with rip rap stone to minimize potential soil erosion into the ditch during discharge events.

4.4 Mitigation of Noise Impacts

To minimize the potential for noise impacts, construction equipment and transport vehicles should have mufflers working properly, and construction activities should be limited to daylight hours only.

4.5 Mitigation of Impacts to Health and Safety

To minimize impacts to health and safety of workers and the public, the construction specifications should state that the contractor have a safety program in place, in accordance with all federal and provincial health and safety regulations. During construction, site access will be limited to the construction crew only. Personal protective equipment will be worn in accordance with the contractor's safety program.

4.6 Mitigation of Impacts to Heritage Resources

If any significant historic or heritage resources are discovered in the course of excavation or construction, the specifications should identify that works are to temporarily cease and an investigation of the site is to be conducted by the RM, Manitoba Historic Resources Branch and any other authority as may be required.

5.0 RESIDUAL AND CUMULATIVE EFFECTS

Residual environmental effects remaining after the application of mitigation measures, to the extent possible expressed in quantitative terms relative to baseline conditions

No negative residual effects are anticipated through the construction and operation of the expanded and upgraded wastewater treatment lagoon, due to the mitigation measures described above. Positive residual effects are expected from the properly sized wastewater treatment system, which will allow for expansion of the service area in the future.

No cumulative effects are anticipated from other construction works in the area. Cumulative impacts to the discharge route are expected as the discharge volume would increase significantly with the addition of two new storage cells.

6.0 MONITORING AND FOLLOW-UP

Proposed follow-up activities that will be required at any stage of development (eg. Monitoring, inspection, surveillance, audit, etc.)

Monitoring of the lagoon operation is to be conducted by a trained lagoon operator, who is to ensure the lagoon is operated under the requirements of the Environment Act licence. The operator is to ensure liquid levels in the lagoon cells are maintained within the required limits; conduct sampling of lagoon effluent prior to and during discharge; and ensure water quality parameters as described in the Environment Act licence are met. The operator is also to maintain records of discharge events and water quality monitoring for reporting to Manitoba Conservation (if requested). If there are any concerns with the operation of the lagoon, the owner is to contact the local environment officer to discuss options. The construction contractor is to ensure that grass growth occurs on slopes and disturbed areas, after the construction activities are completed.

7.0 FUNDING AND APPROVALS

Name and address of any Government Agency or program (federal, provincial or otherwise) from which a grant or loan of capital funds have been requested (where applicable). Other federal, provincial or municipal approvals, licences, permits, authorizations, etc. known to be required for the proposed development, and the status of the project's application or approval.

Partial funding for the project works are being sought from the Manitoba Water Services Board. Approval from Manitoba Hydro will be required for installing the intercell pipe through the overhead transmission line corridor. No additional approvals, licences or permits are anticipated for the lagoon construction and operation. The RM of Pipestone will also be responsible for registering the lagoon with Environment Canada and providing annual monitoring reports to Environment Canada under the *Federal Wastewater Systems Effluent Regulations*.

8.0 PUBLIC CONSULTATION

Results of any public consultations undertaken or to be undertaken in conjunction with project planning.

Public consultation by the RM of Pipestone has not been conducted to date for the residents of Reston. Public consultation for residents would likely occur during future phases of the project, once funding has been established. Public comments will be received by Manitoba Conservation through the public registry during the Environmental Act Proposal review period.

9.0 CONCLUSION

Based on the design of the project and the implementation of the mitigation measures identified in Section 4.0 above, no significant negative environmental impacts are anticipated.

The proponent would like to complete the requirements of the Environment Act Proposal as soon as possible so that the lagoon design and construction can begin in a timely fashion.

JR Cousin Consultants Ltd. requests that a draft copy of the Environment Act Licence be forwarded for review prior to the issue of the final licence.

APPENDICES

Appendix A

Land Title

Crown Lands & Property Agency - Lands Branch, March 17, 2014 Email Correspondence

Appendix B

Table 1: Reston Lagoon Population, Hydraulic, and Organic Loading Projections to Design Year 20

Manitoba Conservation and Water Stewardship - Wildlife and Ecosystem Protection Branch, January 2, 2014
Email Correspondence

Manitoba Culture, Heritage, Tourism and Sport – Historic Resources Branch, January 13, 2014 Email
Correspondence

Manitoba Conservation and Water Stewardship - Fisheries Branch, January 17, 2014 Email Correspondence

Appendix C

Test Hole Logs

National Testing Laboratories Ltd. Soils Analysis Report, October 11, 2013

National Testing Laboratories Ltd. Soils Analysis Report, November 8, 2013

Stantec Consulting Ltd. Soils Analysis Report, August 28, 2014

Stantec Consulting Ltd. Soils Analysis Report, October 6, 2014

Driller's Well Logs

Appendix D

Title Page

Plan L1: Existing Lagoon and Test Hole Plan

Plan L2: Expanded Lagoon with Setbacks

Plan L3: Proposed Lagoon Layout Plan

Plan L4: Proposed Lagoon Drainage Route

Plan L5: Lagoon Dike Details

Plan L6: Lagoon Fence, Silt Fence, Valve and Rip Rap Details

Appendix A

Land Title

Crown Lands & Property Agency - Lands Branch, March 17, 2014 Email Correspondence

Land Title

DATE: 2014/03/10
TIME: 10:15

MANITOBA
STATUS OF TITLE

TITLE NO: 1891748/2

PAGE: 1

STATUS OF TITLE.....	ACCEPTED	PRODUCED FOR..	OSWALD WOHLGEMUTH
ORIGINATING OFFICE...	BRANDON	ADDRESS.....	91A SCURFIELD BLVD
REGISTERING OFFICE...	BRANDON		WPG MB R3Y 1G4
REGISTRATION DATE....	2002/08/08		
COMPLETION DATE.....	2002/08/12		
		CLIENT FILE...	NA
		PRODUCED BY...	M.DERKSEN

LEGAL DESCRIPTION:

RURAL MUNICIPALITY OF PIPESTONE

IS REGISTERED OWNER SUBJECT TO SUCH ENTRIES RECORDED HEREON IN THE FOLLOWING DESCRIBED LAND:

NLY 1320 FEET PERP OF NE 1/4 5-7-27 WPM EXC
FIRSTLY: ROAD PLAN 1943 BLTO
SECONDLY: ALL MINES AND MINERALS

ACTIVE TITLE CHARGE(S):

R87813/2	ACCEPTED FROM/BY: TO: CONSIDERATION:	CAVEAT MANITOBA HYDRO-ELECTRIC BOARD	REG'D: 1972/09/18	NOTES:
R132277/2	ACCEPTED FROM/BY: TO: CONSIDERATION:	CAVEAT MANITOBA TELEPHONE SYSTEM	REG'D: 1978/10/24	NOTES: NLY 40 FT
87-10505/2	ACCEPTED FROM/BY: TO: CONSIDERATION:	CAVEAT MANITOBA TELEPHONE SYSTEM	REG'D: 1987/09/11	NOTES: PART
1103070/2	ACCEPTED DESCRIPTION: FROM/BY: TO: CONSIDERATION:	CAVEAT EASEMENT AGREEMENT DATED 23 AUGUST 1989 MTS COMMUNICATIONS INC. WILLIAM F. JOHNSTONE AS AGENT	REG'D: 2001/11/02	NOTES: NLY 12 M

ADDRESS(ES) FOR SERVICE:

EFFECT	NAME AND ADDRESS	POSTAL CODE
ACTIVE	RURAL MUNICIPALITY OF PIPESTONE BOX 99 RESTON MB	ROM 1X0

CERTIFIED TRUE EXTRACT PRODUCED FROM THE LAND TITLES DATA STORAGE SYSTEM ON 2014/03/10 OF TITLE NUMBER 1891748/2

***** STATUS OF TITLE 1891748/2 CONTINUED ON NEXT PAGE *****

DATE: 2014/03/10
TIME: 10:15

MANITOBA

TITLE NO: 1891748/2

STATUS OF TITLE

PAGE: 2

STATUS OF TITLE..... ACCEPTED
ORIGINATING OFFICE... BRANDON
REGISTERING OFFICE... BRANDON
REGISTRATION DATE.... 2002/08/08
COMPLETION DATE..... 2002/08/12

PRODUCED FOR.. OSWALD WOHLGEMUTH
ADDRESS..... 91A SCURFIELD BLVD
WPG MB R3Y 1G4

CLIENT FILE... NA
PRODUCED BY... M.DERKSEN

ORIGINATING INSTRUMENT(S):

REGISTRATION NUMBER	TYPE	REG. DATE	CONSIDERATION	SWORN VALUE
1117615/2	T	2002/08/08	\$31,716.00	\$31,716.00

PRESENTED BY: FORREST & FORREST
FROM: T & D FARMS LTD.
TO: RURAL MUNICIPALITY OF PIPESTONE

FROM TITLE NUMBER(S):

1432549/2 ALL

LAND INDEX:

LOT	QUARTER SECTION	SECTION	TOWNSHIP	RANGE
-----	-----------------	---------	----------	-------

NOTE: NE 5 7 27W
NLY 1320 FT PERP EXC RD PL 1943, M & M

ACCEPTED THIS 8TH DAY OF AUGUST, 2002
BY C.RUSSELL FOR THE DISTRICT REGISTRAR OF
THE LAND TITLES DISTRICT OF BRANDON.

CERTIFIED TRUE EXTRACT PRODUCED FROM THE LAND TITLES DATA
STORAGE SYSTEM ON 2014/03/10 OF TITLE NUMBER 1891748/2.

***** END OF STATUS OF TITLE 1891748/2 *****

Crown Lands & Property Agency - Lands Branch, March 17, 2014 Email Correspondence

Oswald Wohlgemut

From: Little, Karen (CLPA) [Karen.Little@gov.mb.ca]
Sent: Monday, March 17, 2014 9:34 AM
To: 'Oswald Wohlgemut'
Subject: RE: Reston Lagoon - Mineral Rights
Attachments: SCN_CT 1591101-2.pdf

Good morning Oswald, according to our records, this date:

The Dominion of Canada granted NE 5-7-27 WPM in April 1901 to the Canadian Pacific Railway Co. along with the Mines & Minerals and Sand & Gravel. The Crown has no interests.

According to CT 1891748/2 – the RM of Pipestone is the registered owner of the “Nly 1320 Feet Perp of NE 5-7-27 WPM EXC.....Secondly: all mines & minerals”.

Sometime between when the grant was issued and when CT 1891748/2 was issued the mines & minerals were severed from the surface title.

A quick review of electronic titles indicate CT 1591101/2 (copy attached) registered to Mary Ludlam & Glenn Ludlam are owners of 1/3 interest of all mines and minerals in NE 5-7-27 WPM as set forth in **Deed No. 133202** and “excluding.....Secondly: and undivided ½ interest in all petroleum, natural gas and related hydrocarbons other than coal as set forth in **Deed and Option No. 119081.**”

I do not know who holds title(s) to the balance 2/3 interest of the mines and minerals however you will need to do further title searches at Brandon Land Titles to determine ownership to the 2/3 interest and as to what exactly was kept from Deed 133202 and Deed and Option No. 119081. The sand and gravel may be still with the surface title 1891748/2.

Sincerely,
Karen Little
Supervisor of Crown Lands Registry

Crown Lands and Property Agency
308 - 25 Tupper Street North
Portage la Prairie MB R1N 3K1
P 204-239-3805 F 204-239-3560
Toll Free 1-866-210-9589
karen.little@gov.mb.ca



An Agency of the Manitoba Government

The information contained in this e-mail and all attachments is confidential and is for the sole use of its intended recipient. It may not be disclosed to or used by anyone other than the addressee. If received in error, please contact the sender by return e-mail and delete this e-mail and all attachments from your system.

Le présent courrier électronique (courriel) et les documents qui y sont attachés peuvent contenir de l'information confidentielle; ils s'adressent exclusivement au destinataire mentionné ci-dessus et nulle autre personne ne doit en prendre connaissance ni les utiliser ou les divulguer. Si vous recevez le présent courriel par erreur, veuillez en aviser l'émetteur immédiatement par courrier électronique et le détruire avec les documents qui y sont attachés.

From: Oswald Wohlgemut [<mailto:owohlgemut@jrcc.ca>]
Sent: March-14-14 11:50 AM
To: Little, Karen (CLPA)
Subject: Reston Lagoon - Mineral Rights

Hello Karen,

JR Cousin Consultants Ltd. is submitting an Environmental Act Proposal on behalf of the RM of Pipestone, regarding the Reston Wastewater Treatment Lagoon expansion project (located at NE 5-7-27 WPM). We have attached a copy of the certificate of title for the parcel of land proposed in the construction works. Could you confirm the ownership of the mineral rights in this parcel of land?

Let me know if you have any questions.

Thank you,

Oswald Wohlgemut, M.Sc.
Environmental Scientist

J.R. Cousin Consultants Ltd.
Phone: (204) 489-0474
Fax: (204) 489-0487
www.jrcc.ca

The information contained in this email and any attachments is privileged, confidential and subject to copyright. It is intended solely for the use of the person(s) to whom it is addressed. If you receive this email in error, please notify the sender by return email and permanently delete it from your system. Note: We have taken precautions against viruses, but take no responsibility for loss or damage caused by any virus present.

Appendix B

Table 1: Reston Lagoon Population, Hydraulic, and Organic Loading Projections to Design Year 20

Manitoba Conservation and Water Stewardship - Wildlife and Ecosystem Protection Branch, January 2, 2014 Email Correspondence

Manitoba Culture, Heritage, Tourism and Sport – Historic Resources Branch, January 13, 2014 Email Correspondence

Manitoba Conservation and Water Stewardship - Fisheries Branch, January 17, 2014 Email Correspondence

Table 1: Reston Lagoon Population, Hydraulic, and Organic Loading Projections to Design Year 20

**TABLE 1
RESTON LAGOON EXPANSION
POPULATION, HYDRAULIC, AND ORGANIC LOADING PROJECTIONS TO DESIGN YEAR 20**

TIMELINE		POPULATION						ORGANIC LOADING				HYDRAULIC LOADING		
CALENDAR YEAR	DESIGN YEAR	COMMUNITY POPULATION	EQUIVALENT COMMERCIAL POPULATION NOT ON PIPED SYSTEM	BUSSED-IN SCHOOL STUDENTS		RURAL POPULATION	RURAL SEPTIC TANK PUMP OUTS PER DAY	DAILY PER CAPITA BOD	DAILY BOD FROM SEPTIC TANK PUMP OUT	DAILY BOD PRODUCTION	PRIMARY CELL Area Req'd at 0.75m	WASTEWATER PRODUCTION (COMMUNITY AND SCHOOL)	TOTAL DAILY WASTEWATER VOLUME	WASTEWATER VOLUME
		3.04% annual growth	Equivalent [1/3]	0.4% annual growth		0.4% annual growth	Residents/Home	(kg)	Septic Tank (x3)	(kg)	[@56kg BOD/ha/day]	(Includes Infiltration)	(cu. m.)	For 230 Days
				Actual	Equivalent [1/3]		2.4		4.15 (kg BOD/tank)		(sq. m.)	L/person/day	(cu. m.)	(cu. m.)
2015	0	550	5	94	31	594	3	0.076	12.5	57.0	10,181	371	218	50,032
2016	1	567	5	94	31	596	3	0.076	12.5	58.3	10,409	371	224	51,467
2017	2	584	6	95	32	598	3	0.076	12.5	59.7	10,658	371	231	53,031
2018	3	602	6	95	32	600	3	0.076	12.5	61.0	10,900	371	237	54,553
2019	4	620	6	96	32	602	3	0.076	12.5	62.4	11,149	371	244	56,122
2020	5	639	7	96	32	604	3	0.076	12.5	64.0	11,420	371	251	57,824
2021	6	658	7	96	32	606	3	0.076	12.5	65.4	11,685	371	259	59,489
2022	7	678	7	97	32	608	3	0.076	12.5	67.0	11,957	371	266	61,204
2023	8	699	8	97	32	610	3	0.076	12.5	68.6	12,252	371	274	63,056
2024	9	720	8	97	32	612	3	0.076	12.5	70.2	12,542	371	282	64,877
2025	10	742	8	98	33	614	3	0.076	12.5	71.9	12,840	371	290	66,752
2026	11	764	8	98	33	616	3	0.076	12.5	73.6	13,147	371	299	68,684
2027	12	787	8	99	33	618	3	0.076	12.5	75.4	13,464	371	307	70,674
2028	13	811	8	99	33	620	3	0.076	12.5	77.2	13,790	371	316	72,724
2029	14	836	8	99	33	622	3	0.076	12.5	79.1	14,126	371	325	74,837
2030	15	861	8	100	33	624	3	0.076	12.5	81.0	14,472	371	335	77,013
2031	16	887	8	100	33	626	3	0.076	12.5	83.0	14,828	371	345	79,254
2032	17	914	8	101	34	629	3	0.076	12.5	85.1	15,196	371	355	81,564
2033	18	942	8	101	34	632	3	0.076	12.5	87.2	15,574	371	365	83,943
2034	19	971	8	101	34	635	3	0.076	12.5	89.4	15,964	371	376	86,395
2035	20	1000	8	102	34	638	3	0.076	12.5	91.6	16,366	371	387	88,920
2052	37	1663	8	109	36	689	3	0.076	12.5	142.2	25,389			

Manitoba Conservation and Water Stewardship - Wildlife and Ecosystem Protection Branch,
January 2, 2014 Email Correspondence

Oswald Wohlgemut

From: Friesen, Chris (CWS) [Chris.Friesen@gov.mb.ca]
Sent: Thursday, January 02, 2014 4:25 PM
To: 'Oswald Wohlgemut'
Subject: RE: Reston Lagoon Expansion - Species at Risk

Oswald

Thank you for your information request. I completed a search of the Manitoba Conservation Data Centre's rare species database and found no occurrences at this time for your area of interest.

The information provided in this letter is based on existing data known to the Manitoba Conservation Data Centre at the time of the request. These data are dependent on the research and observations of CDC staff and others who have shared their data, and reflect our current state of knowledge. **An absence of data in any particular geographic area does not necessarily mean that species or ecological communities of concern are not present;** in many areas, comprehensive surveys have never been completed. Therefore, this information should be regarded neither as a final statement on the occurrence of any species of concern, nor as a substitute for on-site surveys for species as part of environmental assessments.

Because the Manitoba CDC's Biotics database is continually updated and because information requests are evaluated by type of action, any given response is only appropriate for its respective request. Please contact the Manitoba CDC for an update on this natural heritage information if more than six months pass before it is utilized.

Third party requests for products wholly or partially derived from Biotics must be approved by the Manitoba CDC before information is released. Once approved, the primary user will identify the Manitoba CDC as data contributors on any map or publication using Biotics data, as follows as: Data developed by the Manitoba Conservation Data Centre; Wildlife and Ecosystem Protection Branch, Manitoba Conservation.

This letter is for information purposes only - it does not constitute consent or approval of the proposed project or activity, nor does it negate the need for any permits or approvals required by the Province of Manitoba.

We would be interested in receiving a copy of the results of any field surveys that you may undertake, to update our database with the most current knowledge of the area.

If you have any questions or require further information please contact me directly at (204) 945- 7747.

Chris Friesen
Biodiversity Information Manager
Manitoba Conservation Data Centre
204-945-7747
chris.friesen@gov.mb.ca
<http://www.gov.mb.ca/conservation/cdc/>

From: Oswald Wohlgemut [<mailto:owohlgemut@jrcc.ca>]
Sent: December-23-13 2:02 PM
To: Friesen, Chris (CWS)
Subject: Reston Lagoon Expansion - Species at Risk

Hello Chris,

J.R. Cousin Consultants is conducting an Environment Act Proposal on behalf of the RM of Pipestone, Manitoba for the expansion of the existing Reston wastewater lagoon. The construction works will occur at NE 5-7-27 WPM. The area proposed for expansion is an abandoned grassland area directly to the southeast of the existing lagoon cells and is surrounded by agricultural land. Works will include dike construction, perimeter ditch construction and fence installation.

Please provide information on any at risk wildlife and plant species that are known to exist in the location outlined above, as well as any registered habitat areas, as we would like to include that information in the Environmental Act Proposal.

Please let us know if you have any questions.

Thank you,

Oswald Wohlgemut, M.Sc.
Environmental Scientist

J.R. Cousin Consultants Ltd.
Phone: (204) 489-0474
Fax: (204) 489-0487
www.jrcc.ca

The information contained in this email and any attachments is privileged, confidential and subject to copyright. It is intended solely for the use of the person(s) to whom it is addressed. If you receive this email in error, please notify the sender by return email and permanently delete it from your system. Note: We have taken precautions against viruses, but take no responsibility for loss or damage caused by any virus present.

Manitoba Culture, Heritage, Tourism and Sport – Historic Resources Branch, January 13, 2014
Email Correspondence

Oswald Wohlgemut

From: Sitchon, Myra (CHT) [Myra.Sitchon@gov.mb.ca]
Sent: Monday, January 13, 2014 4:14 PM
To: 'Oswald Wohlgemut'
Subject: RE: Reston Lagoon Expansion - Heritage Resources

Hi Oswald,

In response to your memo regarding the above-noted project, I have examined Branch records for areas of potential concern. The potential to impact significant heritage resources is low, and, therefore, the Historic Resources Branch has no concerns with the proposed project.

If at any time however, significant heritage resources are recorded in association with these lands during development, the Historic Resources Branch may require that an acceptable heritage resource management strategy be implemented by the developer to mitigate the effects of development on the heritage resources.

Also, please direct all future requests for review to our general email hrb@gov.mb.ca. If you have any questions or comments, please contact me at 945-6539.

Thanks,
Myra

Myra L. Sitchon, Ph.D.
Impact Assessment Archaeologist,
Archaeological Assessment Services Unit,
Historic Resources Branch
Main Floor- 213 Notre Dame Avenue, Winnipeg, MB R3B 1N3
myra.sitchon@gov.mb.ca

Phone: (204) 945-6539
Toll Free: 1-800-282-8069+extension(6539)
Fax: (204) 948-2384
Website: <http://www.manitoba.ca/heritage>



From: Oswald Wohlgemut [<mailto:owohlgemut@jrcc.ca>]
Sent: December-23-13 2:13 PM
To: Sitchon, Myra (CHT)
Subject: Reston Lagoon Expansion - Heritage Resources

Hello Myra,

J.R. Cousin Consultants is conducting an Environment Act Proposal on behalf of the RM of Pipestone, for the expansion of the Reston lagoon. The construction works will occur at NE 5-7-27 WPM (see attached plan). The area proposed for expansion is an abandoned grassland area adjacent to the existing lagoon cells and surrounding agricultural land. Works will include dike construction, perimeter ditch construction and fence installation.

Please provide any comments or concerns you may have with the proposed project, in regards to historic or heritage resources, as we would like to include that information in the Environment Act Proposal.

Thank you,

Manitoba Conservation and Water Stewardship - Fisheries Branch, January 17, 2014 Email Correspondence

Oswald Wohlgemut

From: Janusz, Laureen R (CWS) [Laureen.Janusz@gov.mb.ca]
Sent: Friday, January 17, 2014 5:10 PM
To: 'Oswald Wohlgemut'
Cc: Bruederlin, Bruno (CWS)
Subject: Fish Info Request Stony Creek near Reston Lagoon Expansion

Hi Oswald,

Sorry for the delay in responding. I want to check with you regarding the section, township and range given provided below. Is that where the effluent would enter a tributary to Stony Creek? The map I am checking on shows no surface water but it is a 1:500,000 scale.

I have the following information for species present in Stony Creek that I had pulled together for another request.

Stony Creek

Fathead minnows¹ and brook stickleback¹

Northern pike, white sucker, emerald shiners, longnose dace, Johnny darter, blackside darter, fathead minnows and brook stickleback.²

¹ Fish Inventory and Habitat Classification System, Fisheries Branch, Manitoba Water Stewardship

² AEC Limited. 2008 Draft report. Fish Distribution Study on the Souris River Tributaries prepared for the West Souris Conservation District. Re distribution: "Stony Creek had pike present near Maple Lake, but the species did not appear to have distributed throughout the system. Pike in Stony Creek and Boshill/Gopher were only encountered in the mid to late summer, well past the spawning time." Also according to this report:

- although white suckers were not collected locals indicate white suckers have been seen.
- emerald shiners were caught as far as the Saskatchewan border on Stoney Creek
- longnose dace were found in a small pool north of Reston, Manitoba.
- Johnny darter, with their characteristic "w" marking were found in several locations on all streams within the study area. On the Gainsborough Creek, Stoney Creek and Boshill/Gopher Creek complex, they were often found in association with Iowa darter, but in far greater numbers.
- Blackside darter never found more than 5 km from a major water body, with the exception of Stoney Creek where the blackside darter was found near highway 83
- With the exception of the fathead minnow, **brook stickleback** were the most common fish found throughout the study area. In Stony Creek, seining of one pool produced several dozen brook stickleback, and no other species.
- fathead minnow was the most broadly distributed and most numerous fish in the study. They were found in virtually all pools, under road crossings, and in small channels with very little water. They were most common in the Stoney Creek....

There is no site specific spawning information for Stony Creek. In FIHCS Stony Creek is rated as a Class 4 waterbody – waterbodies that have severe limitations. The 2008 AEC report indicates:

Stoney Creek would rate as **low value** fish habitat. This is due to a variety of factors as follows:

- Fish passage is highly restricted
- The stream tends to "push up" loose sand/silt/gravel, causing isolated pools to form along much of the creek. This provides good habitat for small bodied fish, but severely limits movement of larger species.
- No large bodied fish were found past highway 83

We would still expect water quality parameters to meet the Manitoba Surface Water Standards Objectives and Guidelines and erosion and control measures be implemented where necessary.

I have cc'd the regional fisheries biologist to verify this and provide any additional information if there is any (thanks Bruno).

Have a great weekend Oswald.

Laureen Janusz
Fisheries Science and Fish Culture Section
Fisheries Branch
Conservation and Water Stewardship
Phone: 204 945-7789
Cell: 204 793-1154
Email: Laureen.Janusz@gov.mb.ca

From: Oswald Wohlgemut [<mailto:owohlgemut@jrcc.ca>]
Sent: December-23-13 2:37 PM
To: Janusz, Laureen R (CWS)
Subject: Reston Lagoon Expansion - Fish Species

Hello Laureen,

J.R. Cousin Consultants Ltd. (JRCC) is preparing an Environment Act Proposal on behalf of the RM of Pipestone for the Reston Lagoon Expansion Project. The proposed expansion will be located adjacent to the existing lagoon cells and will discharge into a local drain which flows southeast to Stony Creek located at 21-6-27 WPM.

If you have the data, please provide a list of fish species known to exist in the Stony Creek. Please also provide any fish spawning information for this area, if available, as we would like to include this information in the Environment Act Proposal.

Please do not hesitate to contact us if you have any questions.

Thank you,

Oswald Wohlgemut, M.Sc.
Environmental Scientist

J.R. Cousin Consultants Ltd.
Phone: (204) 489-0474
Fax: (204) 489-0487
www.jrcc.ca

The information contained in this email and any attachments is privileged, confidential and subject to copyright. It is intended solely for the use of the person(s) to whom it is addressed. If you receive this email in error, please notify the sender by return email and permanently delete it from your system. Note: We have taken precautions against viruses, but take no responsibility for loss or damage caused by any virus present.

Appendix C

Test Hole Logs

National Testing Laboratories Ltd. Soils Analysis Report, October 11, 2013

National Testing Laboratories Ltd. Soils Analysis Report, November 8, 2013

Stantec Consulting Ltd. Soils Analysis Report, August 28, 2014

Stantec Consulting Ltd. Soils Analysis Report, October 6, 2014

Driller's Well Logs

Test Hole Logs

J. R. Cousin Consultants Ltd.
TEST HOLE LOGS

SYMBOL INDEX



GW. : Well graded gravels and gravel sand mixtures, little or no fines



GP. : Poorly graded gravels, gravel - sand mixtures,
little or no fines



GM. : Silty gravels, gravel-sand-silt mixtures



GC. : Clayey gravels, gravel-sand-clay mixtures



SW. : Well graded sands, gravelly sands, little or no fines



SP. : Poorly graded sands, or gravelly sands, little or no fines



SM. : Silty sands, sand-silt mixtures



SC. : Clayey sands, sand-clay mixtures



ML. : Inorganic silts and very fine sands, rock flour, silty or clayey fine sands,
or clayey silts with slight plasticity



CL. : Inorganic clays of low plasticity, gravelly clays, sandy or silty
clays, lean clays



OL. : Organic silts and organic silty clays of low plasticity



CI. : Inorganic clays of medium or intermediate plasticity



MH. : Inorganic silts, fine sandy or silty soils



CH. : Inorganic clays of high plasticity, fat clays



OH. : Organic clays of medium to high plasticity, organic silts



Pt. : Peat, humus, swamp soils with high organic contents



TOPSOIL

The soil logs are based upon objective data available to us at the time of forming our opinions. The soil logs indicate site specific soil characteristics and must not be generalized over larger areas due to the limited number of test holes as compared to that of an unlimited number of test holes. Every effort is made to evaluate the information by methods generally recognized. The soil logs represent our opinions. J. R. Cousin Consultants Ltd. cannot be responsible for actual site conditions proved to be materially at variance from our analysis or from the data generalization over untested areas.

J. R. Cousin Consultants Ltd.

TEST HOLE LOG SHEET

LOCATION : NE 5-7-27W

CODE : P-118.07

DATE : September 19, 2013

COORDINATES: N 5490227, E 347514

METHOD OF SAMPLING : Drill Rig

TEST HOLE # 1

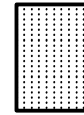
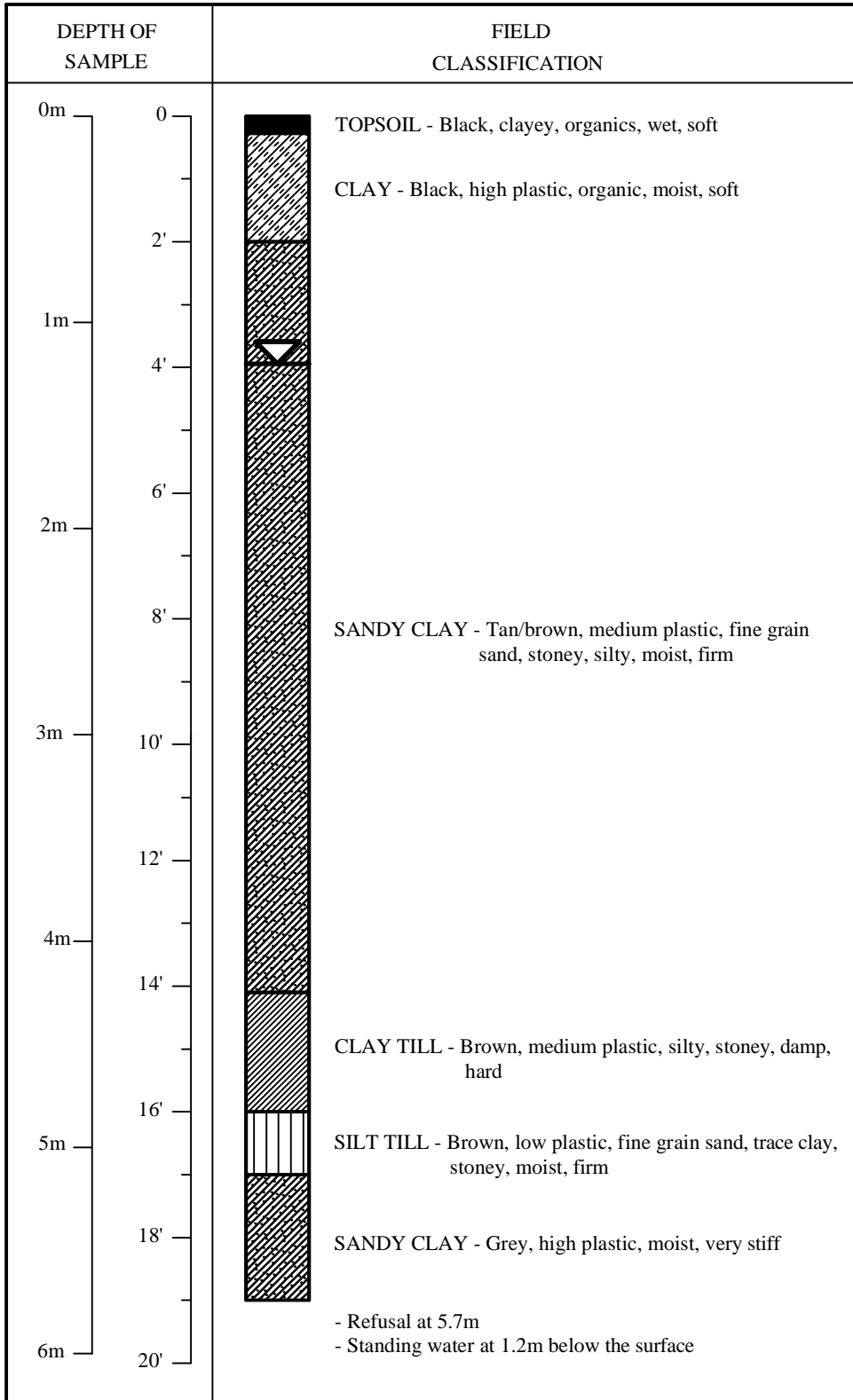

GW



GP

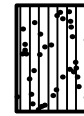

GM

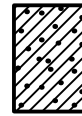

GC



SW



SP



SM



SC

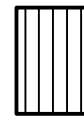

ML

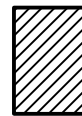

CL



OL



CI

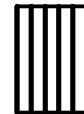

MH



CH



OH



PT



Topsoil



Static Water Level

The soil logs are based upon objective data available to us at the time of forming our opinions. The soil logs indicate site specific soil characteristics and must not be generalized over larger areas due to the limited number of test holes as compared to that of an unlimited number of test holes. Every effort is made to evaluate the information by methods generally recognized. The soil represent our opinions. J.R. Cousin Consultants Ltd. cannot be responsible for actual site conditions proved to be materially at variance from our analysis or from the data generalization over untested areas.

J. R. Cousin Consultants Ltd.

TEST HOLE LOG SHEET

LOCATION : NE 5-7-27W

CODE : P-118.07

DATE : September 19, 2013

COORDINATES: N 5490213, E 347632

METHOD OF SAMPLING : Drill Rig

TEST HOLE # 2

PROJECT : Reston Lagoon Study

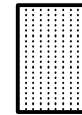
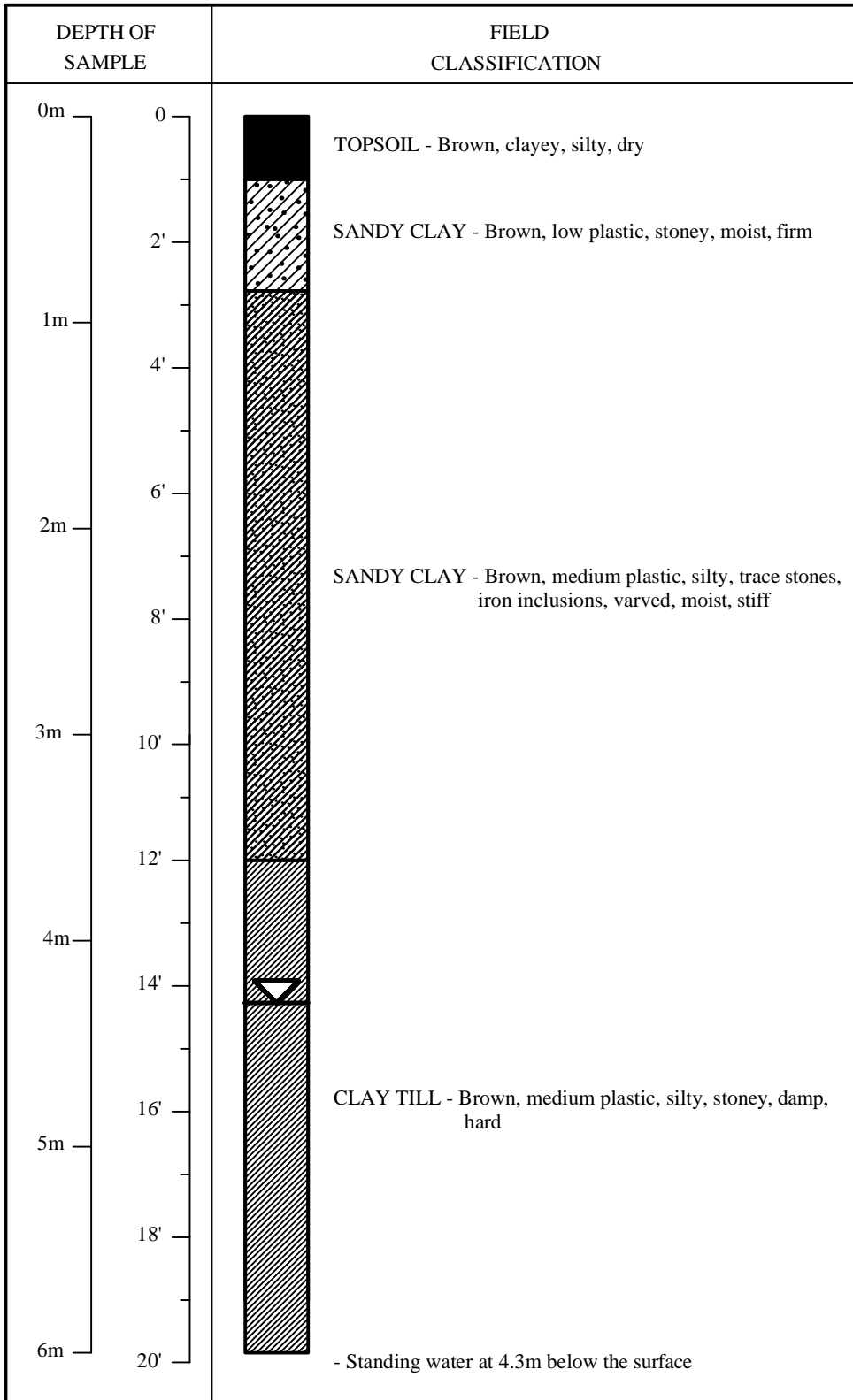

GW

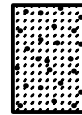

GP

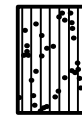

GM

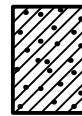

GC



SW

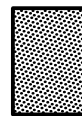

SP



SM



SC

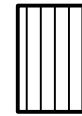

ML

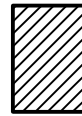

CL



OL



CI

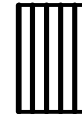

MH



CH



OH



PT



Topsoil



Static Water Level

The soil logs are based upon objective data available to us at the time of forming our opinions. The soil logs indicate site specific soil characteristics and must not be generalized over larger areas due to the limited number of test holes as compared to that of an unlimited number of test holes. Every effort is made to evaluate the information by methods generally recognized. The soil represent our opinions. J.R. Cousin Consultants Ltd. cannot be responsible for actual site conditions proved to be materially at variance from our analysis or from the data generalization over untested areas.

J. R. Cousin Consultants Ltd.

TEST HOLE LOG SHEET

LOCATION : NE 5-7-27W

CODE : P-118.07

DATE : September 19, 2013

COORDINATES: N 5490140, E 347554

METHOD OF SAMPLING : Drill Rig

TEST HOLE # 3

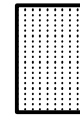
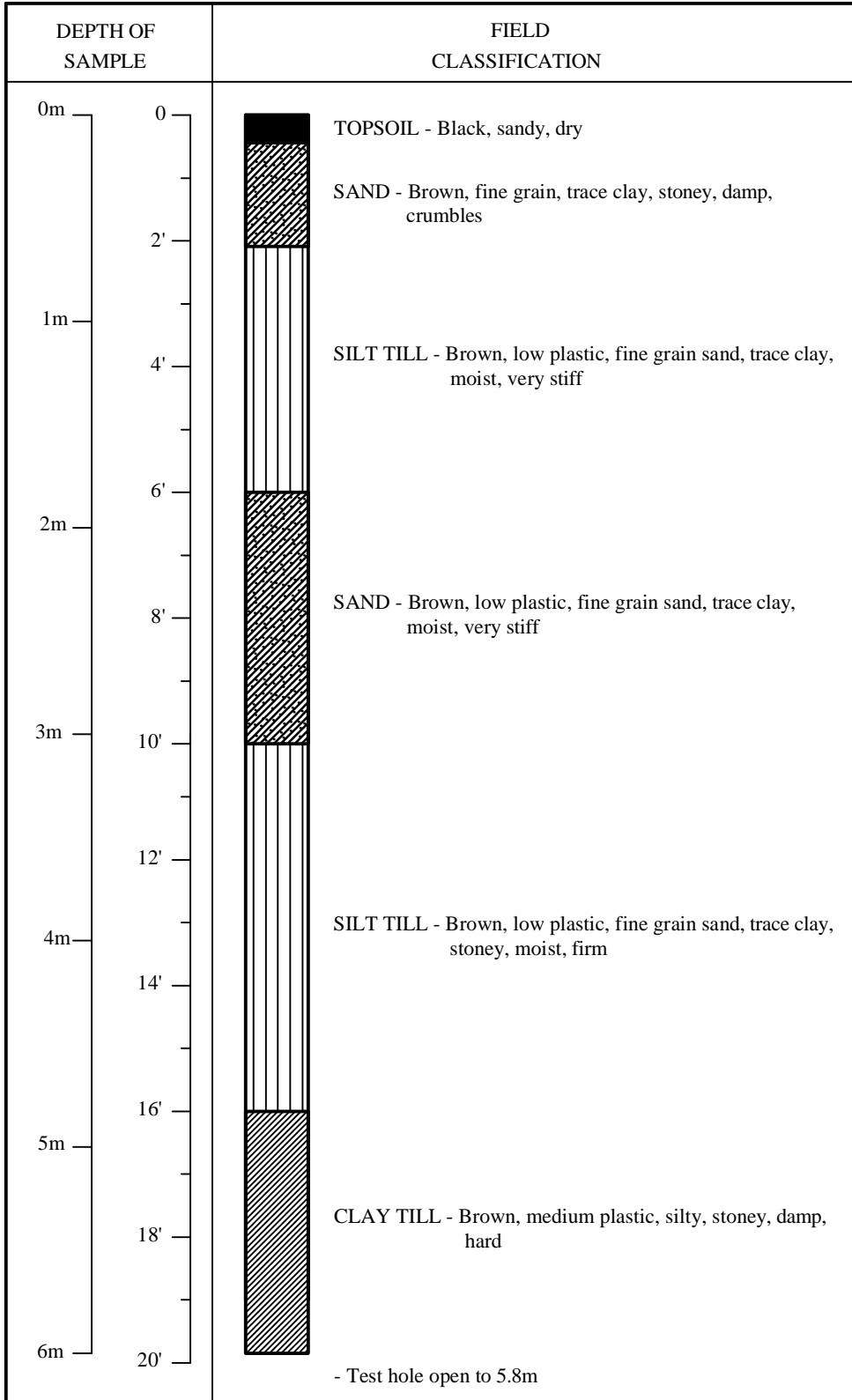

GW

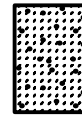

GP

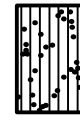

GM

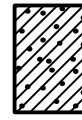

GC



SW



SP



SM



SC

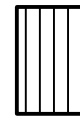

ML

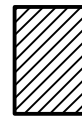

CL

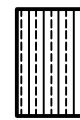

OL



CI



MH

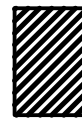

CH



OH



PT



Topsoil



Static Water Level

The soil logs are based upon objective data available to us at the time of forming our opinions. The soil logs indicate site specific soil characteristics and must not be generalized over larger areas due to the limited number of test holes as compared to that of an unlimited number of test holes. Every effort is made to evaluate the information by methods generally recognized. The soil represent our opinions. J.R. Cousin Consultants Ltd. cannot be responsible for actual site conditions proved to be materially at variance from our analysis or from the data generalization over untested areas.

J. R. Cousin Consultants Ltd.

TEST HOLE LOG SHEET

LOCATION : NE 5-7-27W

CODE : P-118.07

DATE : September 19, 2013

COORDINATES: N 5490097, E 347516

METHOD OF SAMPLING : Drill Rig

TEST HOLE # 4

PROJECT : Reston Lagoon Study

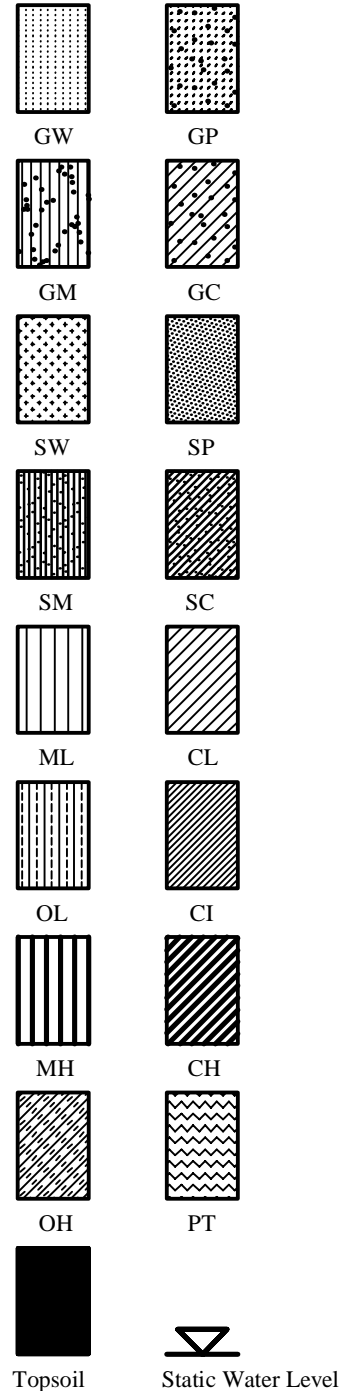
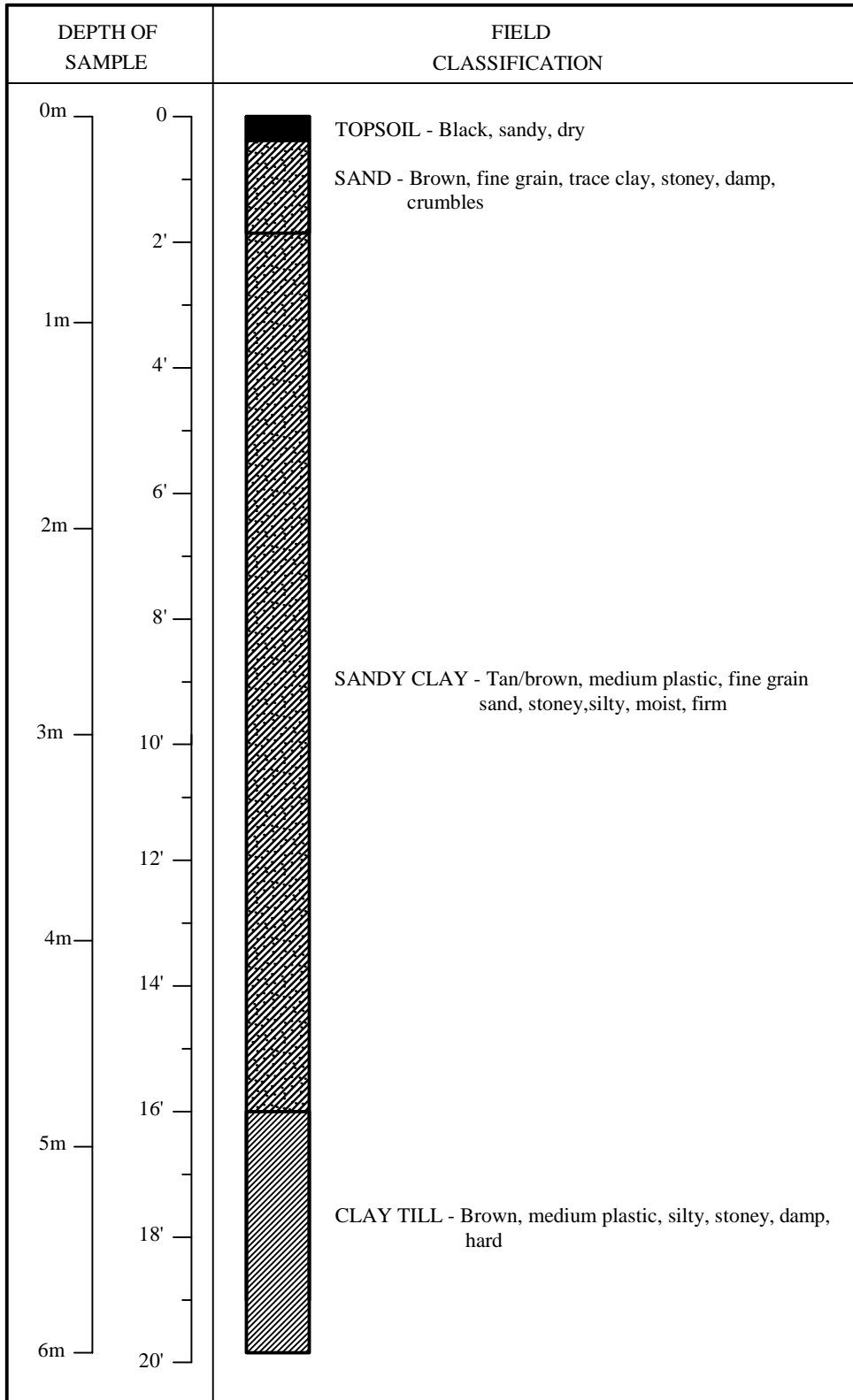

The soil logs are based upon objective data available to us at the time of forming our opinions. The soil logs indicate site specific soil characteristics and must not be generalized over larger areas due to the limited number of test holes as compared to that of an unlimited number of test holes. Every effort is made to evaluate the information by methods generally recognized. The soil represent our opinions. J.R. Cousin Consultants Ltd. cannot be responsible for actual site conditions proved to be materially at variance from our analysis or from the data generalization over untested areas.

J. R. Cousin Consultants Ltd.

TEST HOLE LOG SHEET

LOCATION : NE 5-7-27W

CODE : P-118.07

DATE : September 19, 2013

COORDINATES: N 5490044, E 347597

METHOD OF SAMPLING : Drill Rig

TEST HOLE # 5

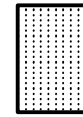
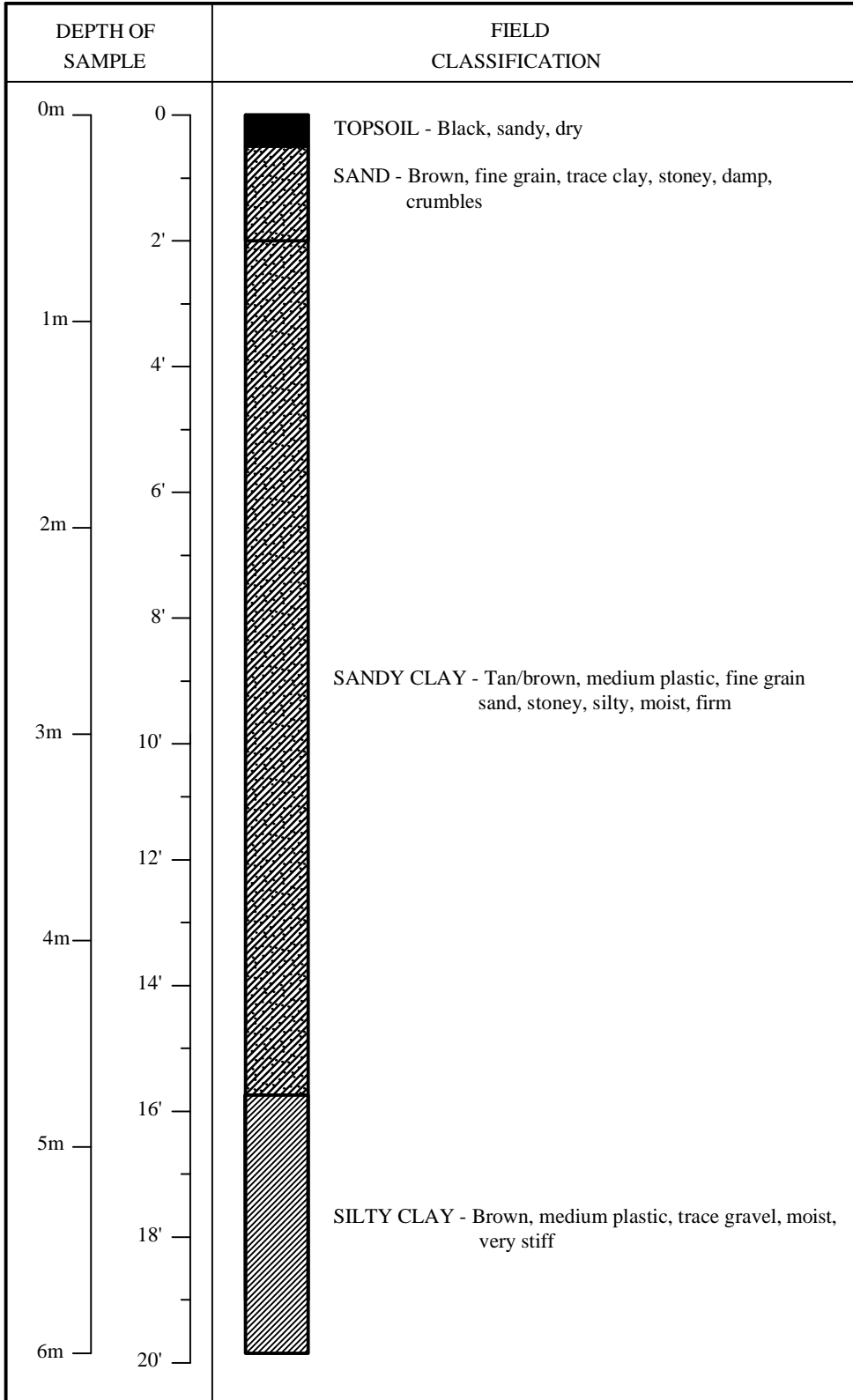

GW

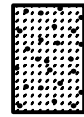

GP

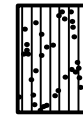

GM

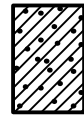

GC



SW

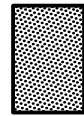

SP



SM



SC

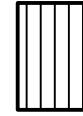

ML

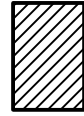

CL



OL

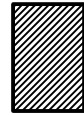

CI



MH

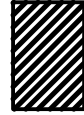

CH



OH

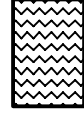

PT



Topsoil



Static Water Level

The soil logs are based upon objective data available to us at the time of forming our opinions. The soil logs indicate site specific soil characteristics and must not be generalized over larger areas due to the limited number of test holes as compared to that of an unlimited number of test holes. Every effort is made to evaluate the information by methods generally recognized. The soil represent our opinions. J.R. Cousin Consultants Ltd. cannot be responsible for actual site conditions proved to be materially at variance from our analysis or from the data generalization over untested areas.

J. R. Cousin Consultants Ltd.

TEST HOLE LOG SHEET

LOCATION : NE 5-7-27W

CODE : P-118.07

DATE : September 19, 2013

COORDINATES: N 5490107, E 347414

METHOD OF SAMPLING : Drill Rig

TEST HOLE # 6

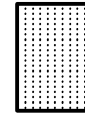
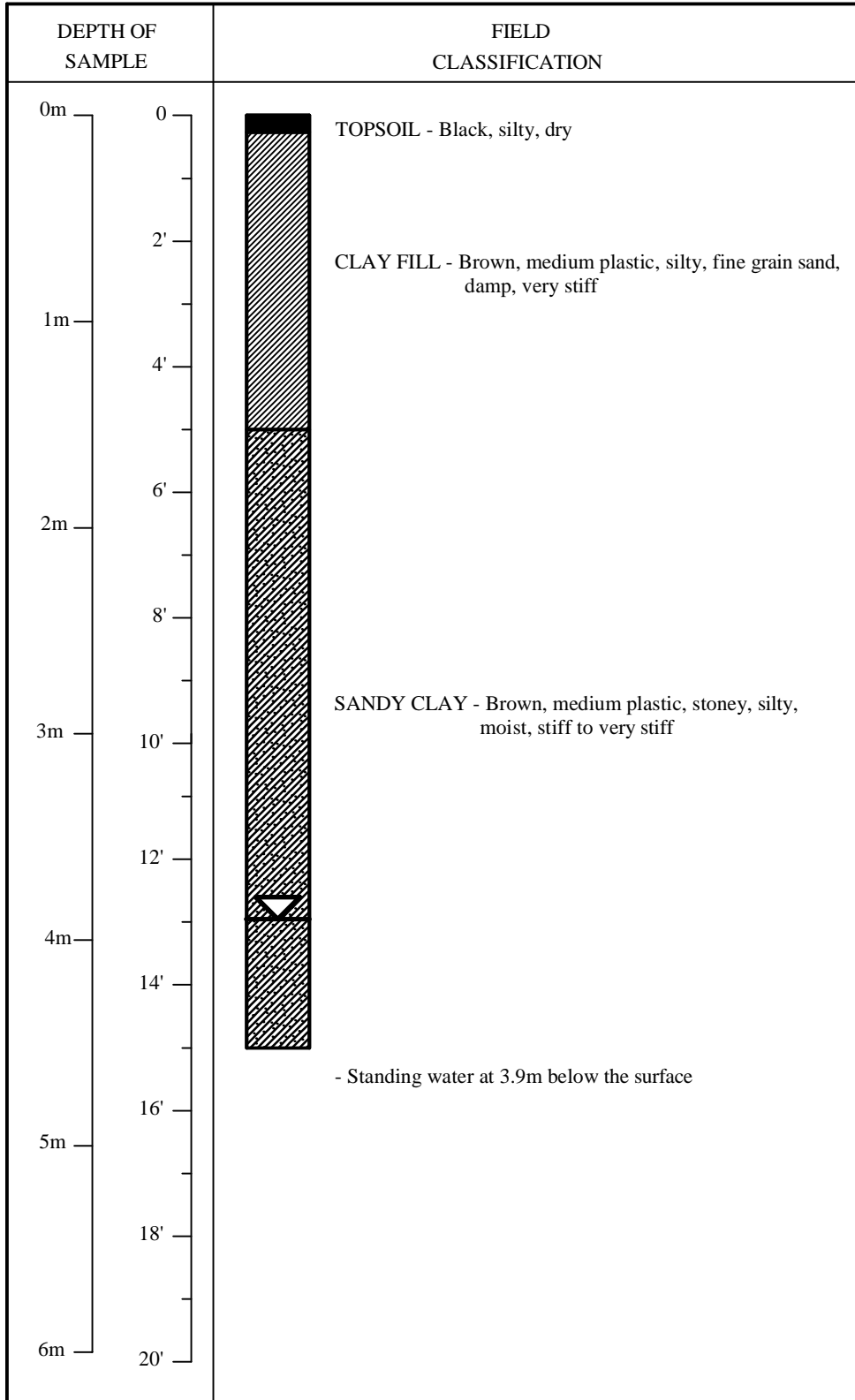

GW

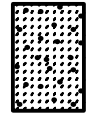

GP

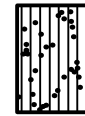

GM

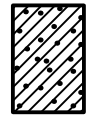

GC



SW

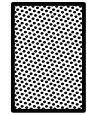

SP



SM

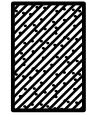

SC

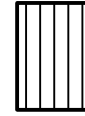

ML

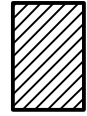

CL



OL

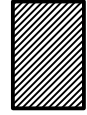

CI

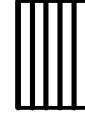

MH



CH



OH



PT



Topsoil

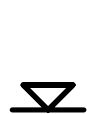

Static Water Level

The soil logs are based upon objective data available to us at the time of forming our opinions. The soil logs indicate site specific soil characteristics and must not be generalized over larger areas due to the limited number of test holes as compared to that of an unlimited number of test holes. Every effort is made to evaluate the information by methods generally recognized. The soil represent our opinions. J.R. Cousin Consultants Ltd. cannot be responsible for actual site conditions proved to be materially at variance from our analysis or from the data generalization over untested areas.

J. R. Cousin Consultants Ltd.

TEST HOLE LOG SHEET

LOCATION : NE 5-7-27W

CODE : P-118.07

DATE : September 19, 2013

COORDINATES: N 5490257, E 347398

METHOD OF SAMPLING : Drill Rig

TEST HOLE # 7

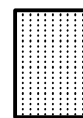
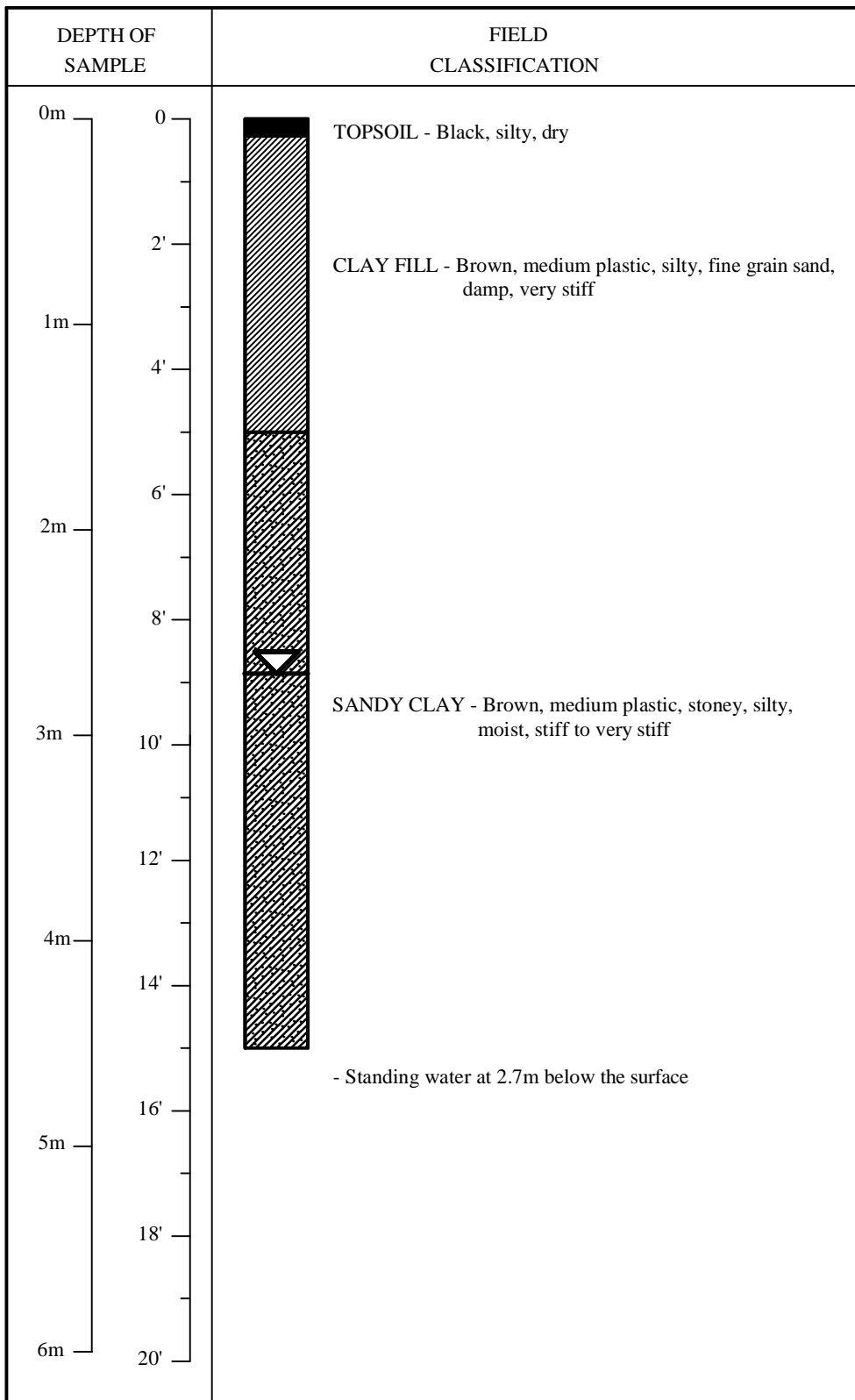

GW



GP

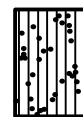

GM

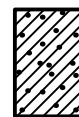

GC



SW

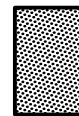

SP



SM



SC

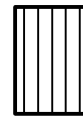

ML

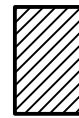

CL



OL



CI



MH



CH



OH



PT



Topsoil



Static Water Level

The soil logs are based upon objective data available to us at the time of forming our opinions. The soil logs indicate site specific soil characteristics and must not be generalized over larger areas due to the limited number of test holes as compared to that of an unlimited number of test holes. Every effort is made to evaluate the information by methods generally recognized. The soil represent our opinions. J.R. Cousin Consultants Ltd. cannot be responsible for actual site conditions proved to be materially at variance from our analysis or from the data generalization over untested areas.

J. R. Cousin Consultants Ltd.

TEST HOLE LOG SHEET

LOCATION : NE 5-7-27W

CODE : P-118.07

DATE : September 19, 2013

COORDINATES: N 5490253, E 347526

METHOD OF SAMPLING : Drill Rig

TEST HOLE # 8

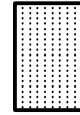
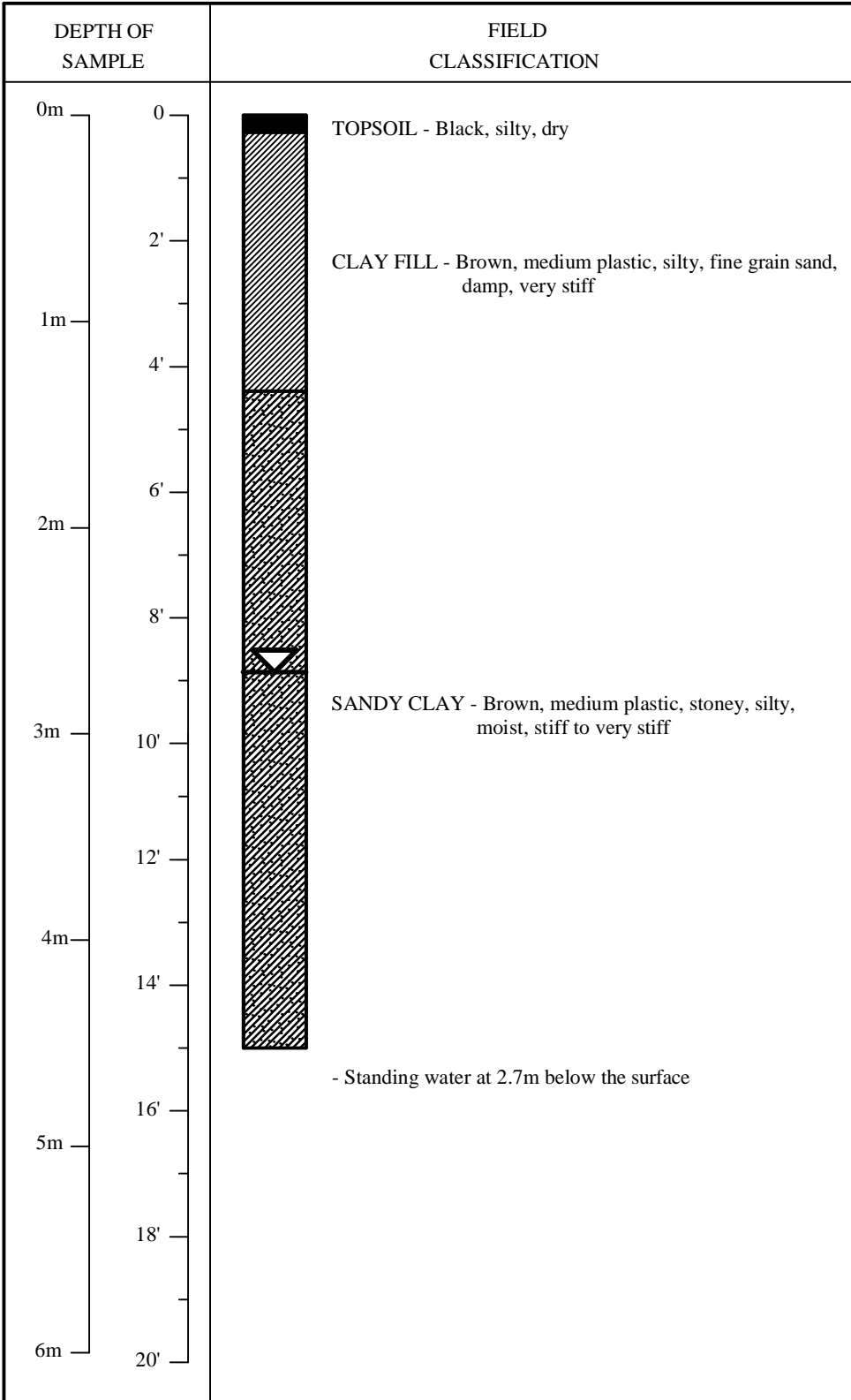

GW

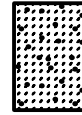

GP



GM

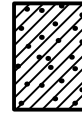

GC



SW



SP



SM



SC

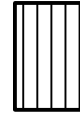

ML

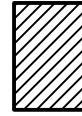

CL



OL



CI

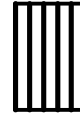

MH



CH



OH



PT



Topsoil



Static Water Level

The soil logs are based upon objective data available to us at the time of forming our opinions. The soil logs indicate site specific soil characteristics and must not be generalized over larger areas due to the limited number of test holes as compared to that of an unlimited number of test holes. Every effort is made to evaluate the information by methods generally recognized. The soil represent our opinions. J.R. Cousin Consultants Ltd. cannot be responsible for actual site conditions proved to be materially at variance from our analysis or from the data generalization over untested areas.

J. R. Cousin Consultants Ltd.

TEST HOLE LOG SHEET

LOCATION : NE 5-7-27W

CODE : P-118.07

DATE : September 19, 2013

COORDINATES: N 5490322, E 347581

METHOD OF SAMPLING : Drill Rig

TEST HOLE # 9

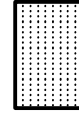
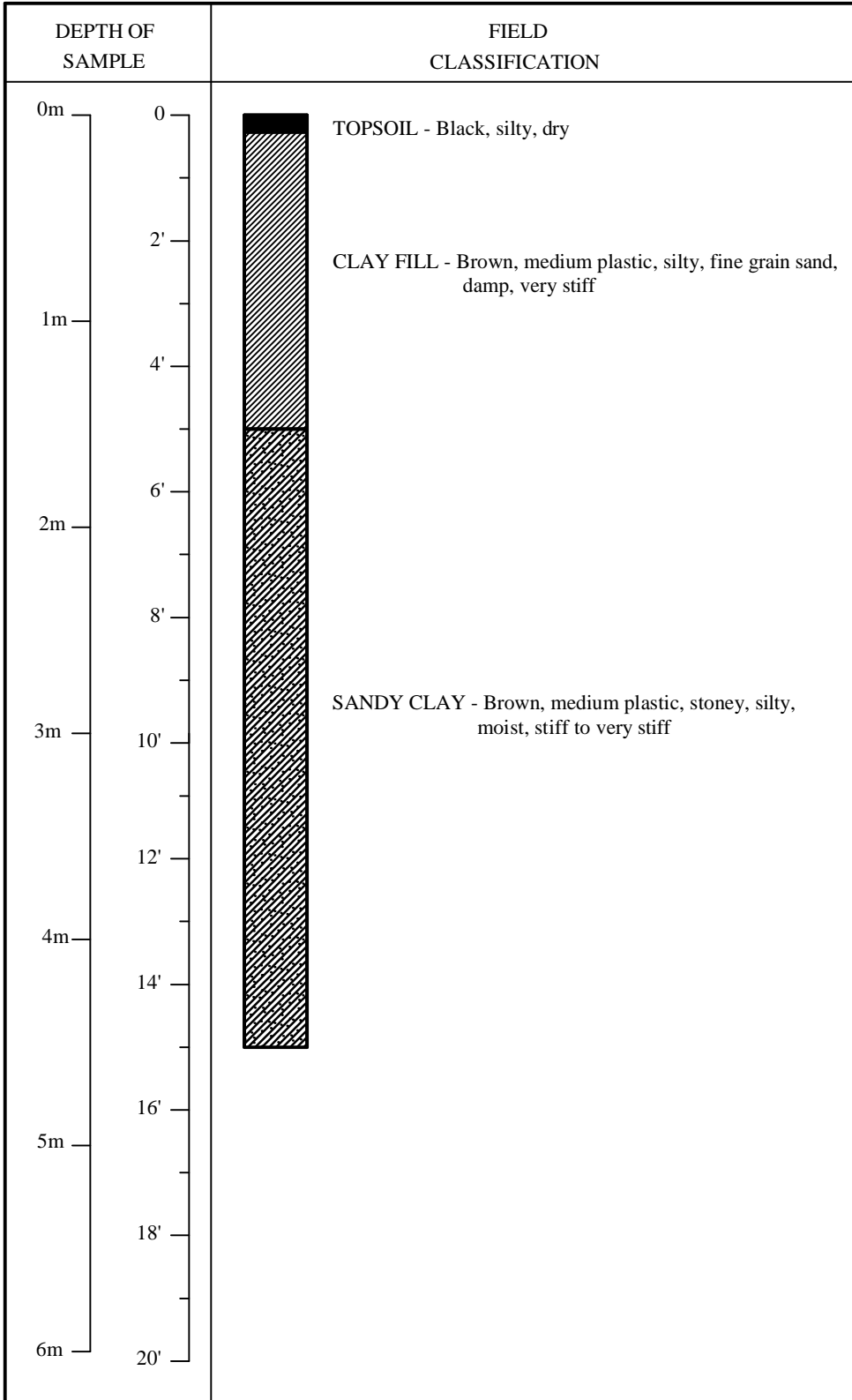

GW

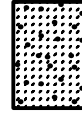

GP

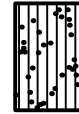

GM

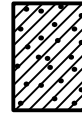

GC



SW

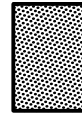

SP



SM



SC

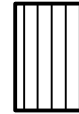

ML

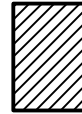

CL



OL



CI



MH



CH



OH



PT



Topsoil



Static Water Level

The soil logs are based upon objective data available to us at the time of forming our opinions. The soil logs indicate site specific soil characteristics and must not be generalized over larger areas due to the limited number of test holes as compared to that of an unlimited number of test holes. Every effort is made to evaluate the information by methods generally recognized. The soil represent our opinions. J.R. Cousin Consultants Ltd. cannot be responsible for actual site conditions proved to be materially at variance from our analysis or from the data generalization over untested areas.

J. R. Cousin Consultants Ltd.

TEST HOLE LOG SHEET

LOCATION : Reston Lagoon NE 5-7-27 WPM
 COORDINATES : N 5490415, E 347647
 PROJECT : Reston Lagoon Study

CODE : P-118.07
 ELEVATION : 464.571m
 METHOD OF SAMPLING : Drill Rig

DATE : August 14, 2014
 TEST HOLE # 10

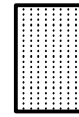
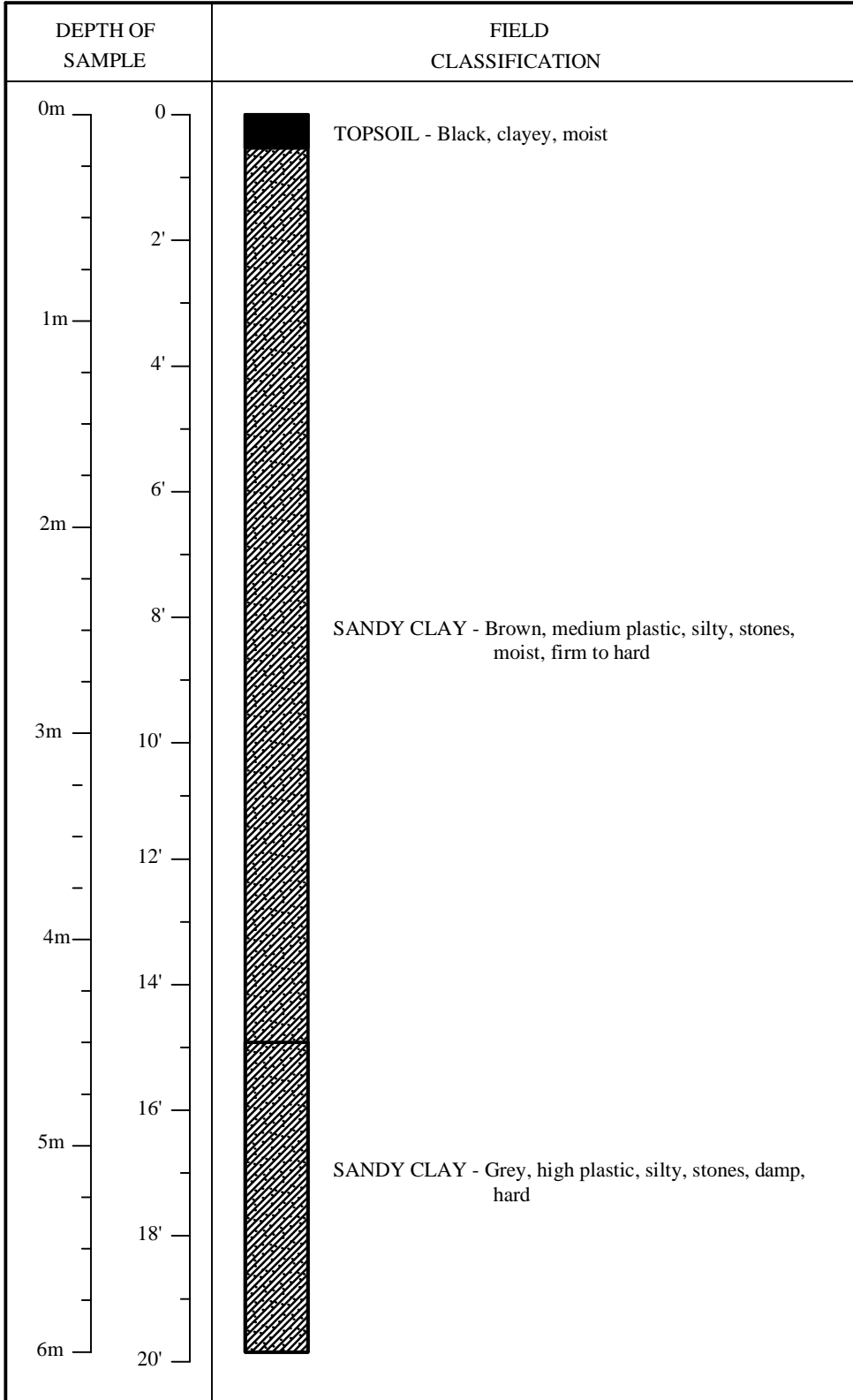

GW

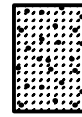

GP

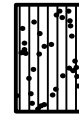

GM

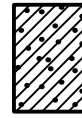

GC



SW



SP

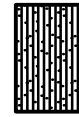

SM



SC

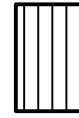

ML



CL



OL



CI



MH



CH



OH



PT



Topsoil



Static Water Level

The soil logs are based upon objective data available to us at the time of forming our opinions. The soil logs indicate site specific soil characteristics and must not be generalized over larger areas due to the limited number of test holes as compared to that of an unlimited number of test holes. Every effort is made to evaluate the information by methods generally recognized. The soil represent our opinions. J.R. Cousin Consultants Ltd. cannot be responsible for actual site conditions proved to be materially at variance from our analysis or from the data generalization over untested areas.

J. R. Cousin Consultants Ltd.

TEST HOLE LOG SHEET

LOCATION : Reston Lagoon NE 5-7-27 WPM
 COORDINATES : N 5490426, E 347751
 PROJECT : Reston Lagoon Study

CODE : P-118.07
 ELEVATION : 464.455m
 METHOD OF SAMPLING : Drill Rig

DATE : August 14, 2014
 TEST HOLE # 11

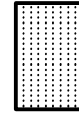
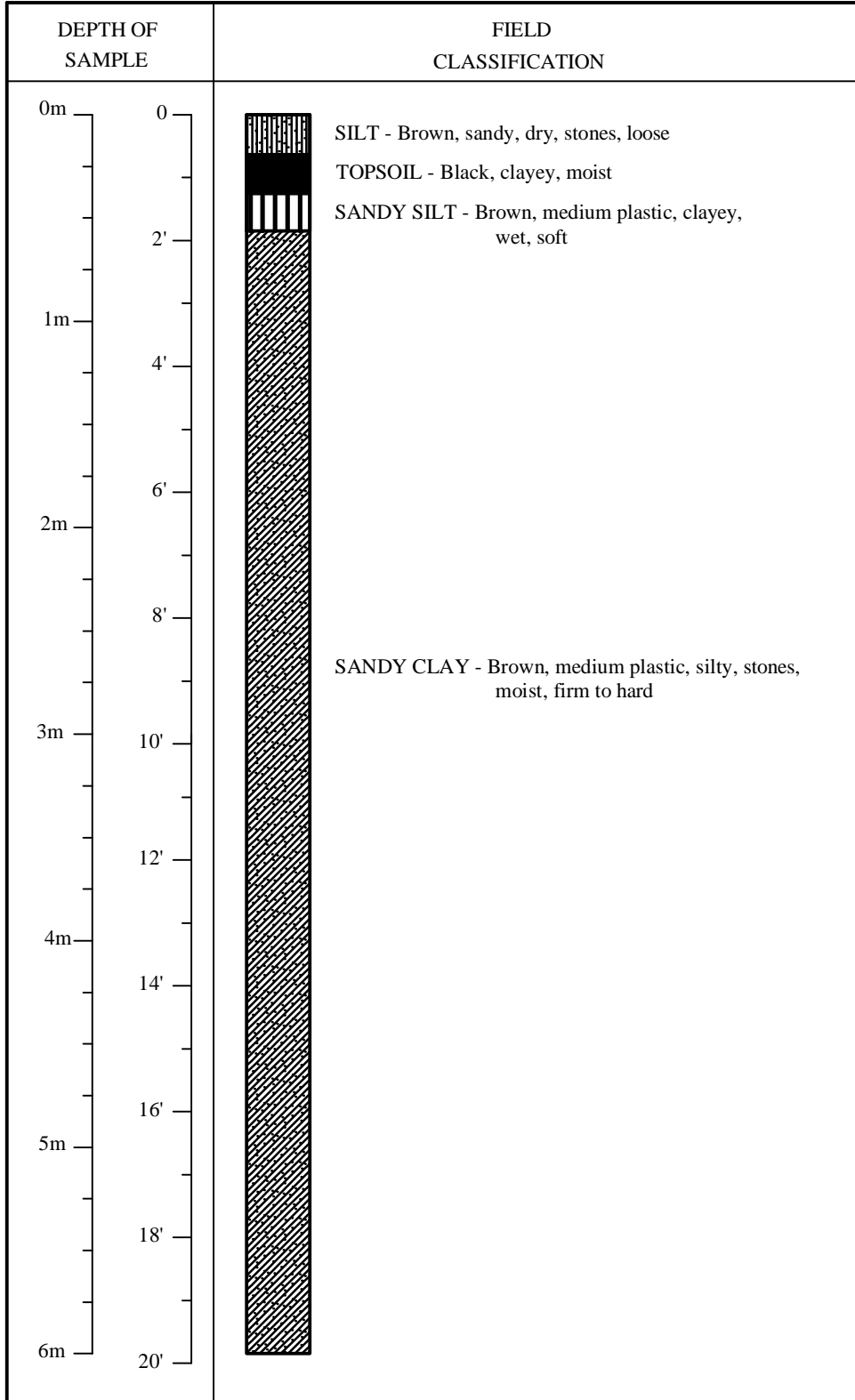

GW

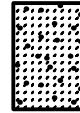

GP

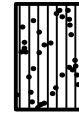

GM

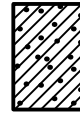

GC



SW



SP



SM



SC

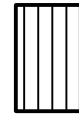

ML

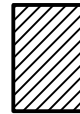

CL



OL



CI



MH



CH



OH



PT



Topsoil



Static Water Level

The soil logs are based upon objective data available to us at the time of forming our opinions. The soil logs indicate site specific soil characteristics and must not be generalized over larger areas due to the limited number of test holes as compared to that of an unlimited number of test holes. Every effort is made to evaluate the information by methods generally recognized. The soil represent our opinions. J.R. Cousin Consultants Ltd. cannot be responsible for actual site conditions proved to be materially at variance from our analysis or from the data generalization over untested areas.

J. R. Cousin Consultants Ltd.

TEST HOLE LOG SHEET

LOCATION : Reston Lagoon NE 5-7-27 WPM
 COORDINATES : N 5490371, E 347713
 PROJECT : Reston Lagoon Study

CODE : P-118.07
 ELEVATION : 465.418m
 METHOD OF SAMPLING : Drill Rig

DATE : August 14, 2014
 TEST HOLE # 12

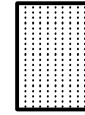
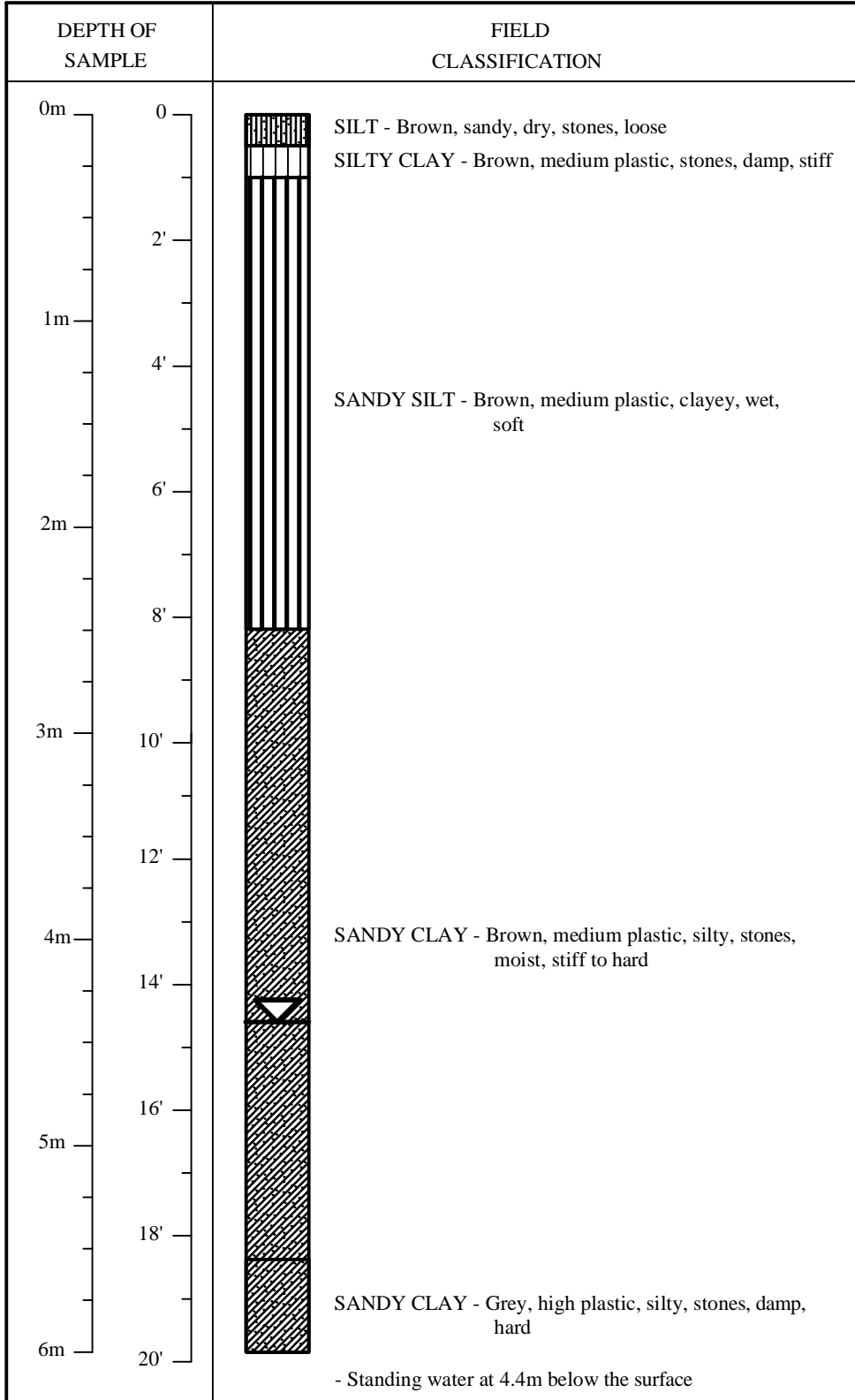

GW

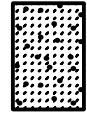

GP

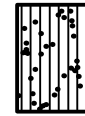

GM

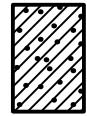

GC



SW

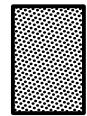

SP



SM

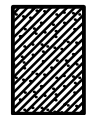

SC

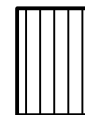

ML

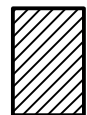

CL



OL



CI

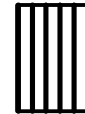

MH

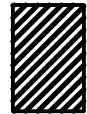

CH



OH

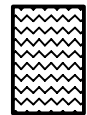

PT



Topsoil



Static Water Level

The soil logs are based upon objective data available to us at the time of forming our opinions. The soil logs indicate site specific soil characteristics and must not be generalized over larger areas due to the limited number of test holes as compared to that of an unlimited number of test holes. Every effort is made to evaluate the information by methods generally recognized. The soil represent our opinions. J.R. Cousin Consultants Ltd. cannot be responsible for actual site conditions proved to be materially at variance from our analysis or from the data generalization over untested areas.

J. R. Cousin Consultants Ltd.

TEST HOLE LOG SHEET

LOCATION : Reston Lagoon NE 5-7-27 WPM
 COORDINATES : N 5490276, E 347829
 PROJECT : Reston Lagoon Study

CODE : P-118.07
 ELEVATION : 464.478m
 METHOD OF SAMPLING : Drill Rig

DATE : August 14, 2014
 TEST HOLE # 13

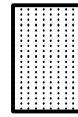
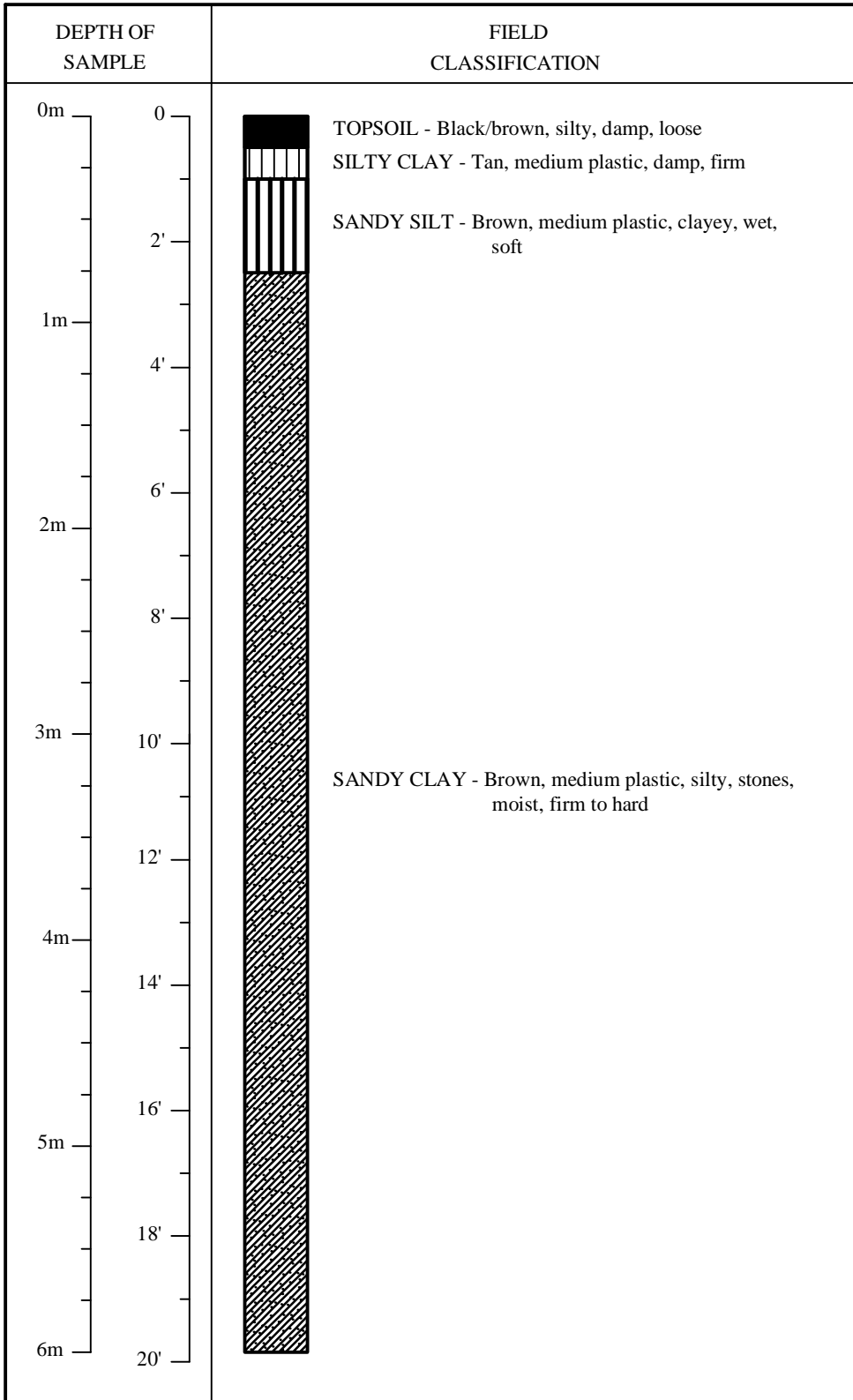

GW

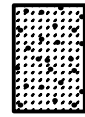

GP

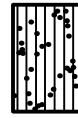

GM

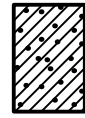

GC



SW

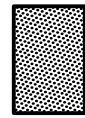

SP

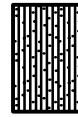

SM



SC

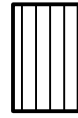

ML

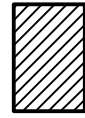

CL



OL



CI



MH



CH



OH



PT



Topsoil



Static Water Level

The soil logs are based upon objective data available to us at the time of forming our opinions. The soil logs indicate site specific soil characteristics and must not be generalized over larger areas due to the limited number of test holes as compared to that of an unlimited number of test holes. Every effort is made to evaluate the information by methods generally recognized. The soil represent our opinions. J.R. Cousin Consultants Ltd. cannot be responsible for actual site conditions proved to be materially at variance from our analysis or from the data generalization over untested areas.

J. R. Cousin Consultants Ltd.

TEST HOLE LOG SHEET

LOCATION : Reston Lagoon NE 5-7-27 WPM
 COORDINATES : N 5490204, E 347886
 PROJECT : Reston Lagoon Study

CODE : P-118.07
 ELEVATION : 464.165m
 METHOD OF SAMPLING : Drill Rig

DATE : August 14, 2014
 TEST HOLE # 14

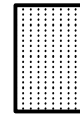
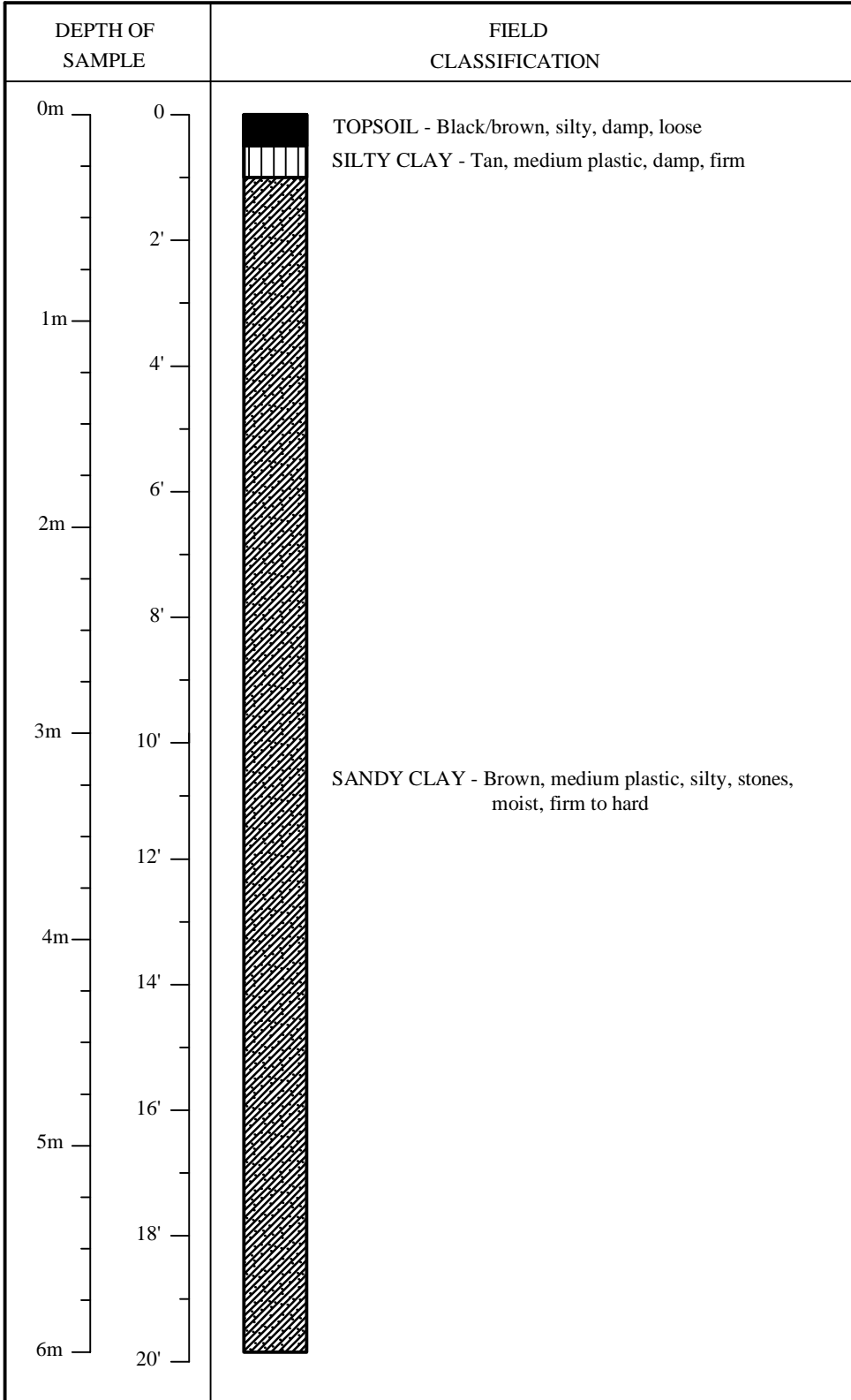

GW

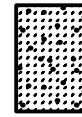

GP

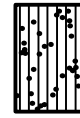

GM

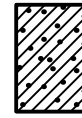

GC



SW



SP

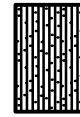

SM



SC

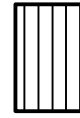

ML

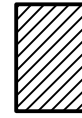

CL



OL



CI

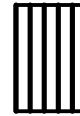

MH



CH



OH



PT



Topsoil



Static Water Level

The soil logs are based upon objective data available to us at the time of forming our opinions. The soil logs indicate site specific soil characteristics and must not be generalized over larger areas due to the limited number of test holes as compared to that of a unlimited number of test holes. Every effort is made to evaluate the information by methods generally recognized. The soil represent our opinions. J.R. Cousin Consultants Ltd. cannot be responsible for actual site conditions proved to be materially at variance from our analysis or from the data generalization over untested areas.

J. R. Cousin Consultants Ltd.

TEST HOLE LOG SHEET

LOCATION : Reston Lagoon NE 5-7-27 WPM
 COORDINATES : N 5490348, E 347819
 PROJECT : Reston Lagoon Study

CODE : P-118.07
 ELEVATION : 463.622m
 METHOD OF SAMPLING : Drill Rig

DATE : August 14, 2014
 TEST HOLE # 15

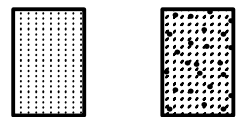
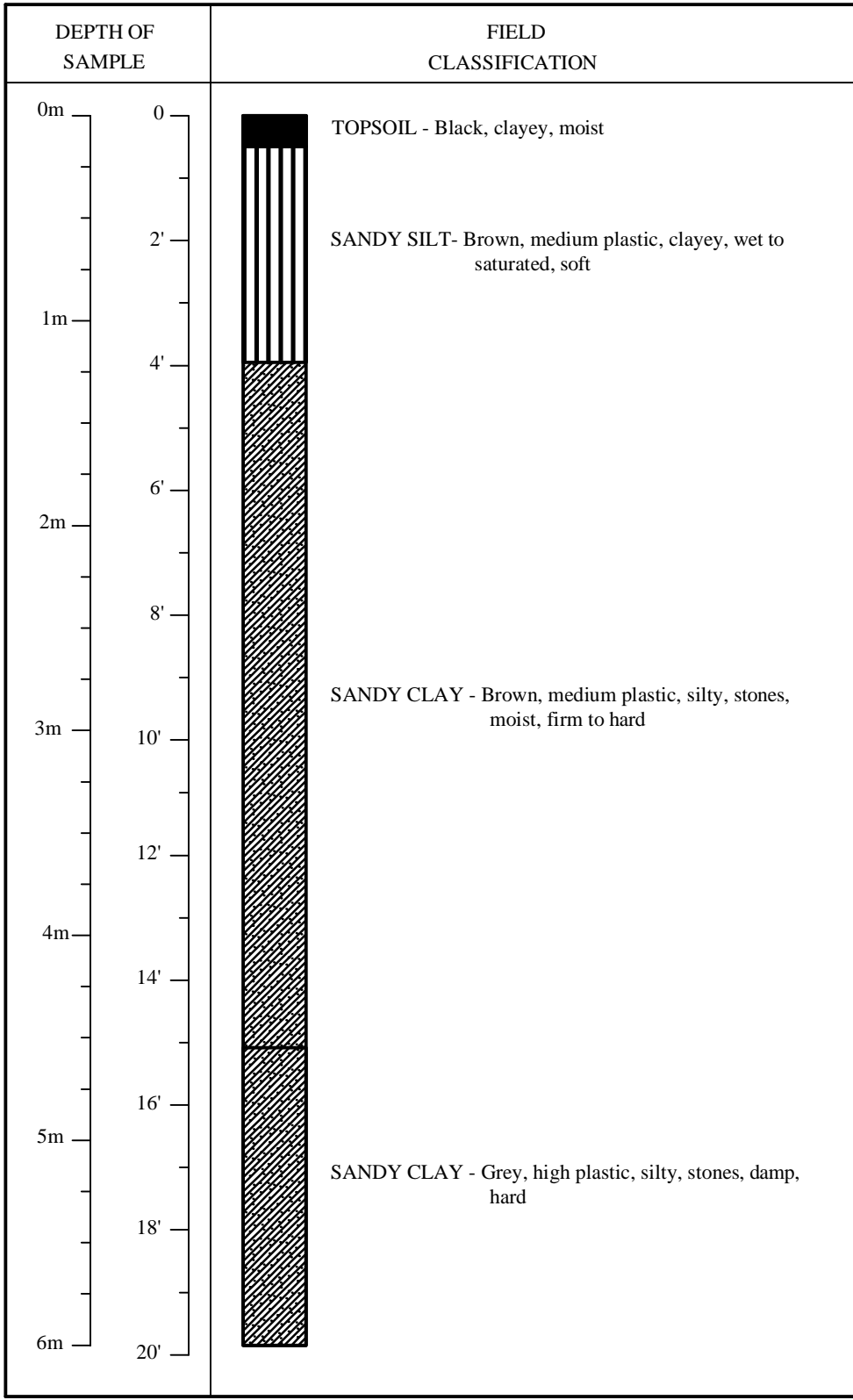

GW

GP

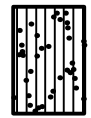

GM

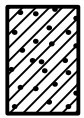

GC

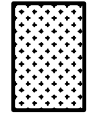

SW

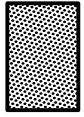

SP

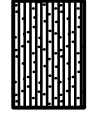

SM

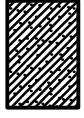

SC

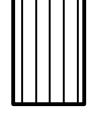

ML

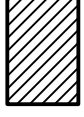

CL

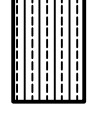

OL

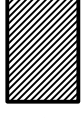

CI

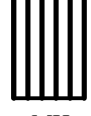

MH

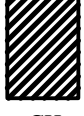

CH

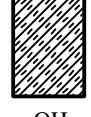

OH



PT



Topsoil



Static Water Level

The soil logs are based upon objective data available to us at the time of forming our opinions. The soil logs indicate site specific soil characteristics and must not be generalized over larger areas due to the limited number of test holes as compared to that of an unlimited number of test holes. Every effort is made to evaluate the information by methods generally recognized. The soil represent our opinions. J.R. Cousin Consultants Ltd. cannot be responsible for actual site conditions proved to be materially at variance from our analysis or from the data generalization over untested areas.

J. R. Cousin Consultants Ltd.

TEST HOLE LOG SHEET

LOCATION : Reston Lagoon NE 5-7-27 WPM
 COORDINATES : N 5490368, E 347670
 PROJECT : Reston Lagoon Study

CODE : P-118.07
 ELEVATION : 465.978m
 METHOD OF SAMPLING : Drill Rig

DATE : August 14, 2014
 TEST HOLE # 16

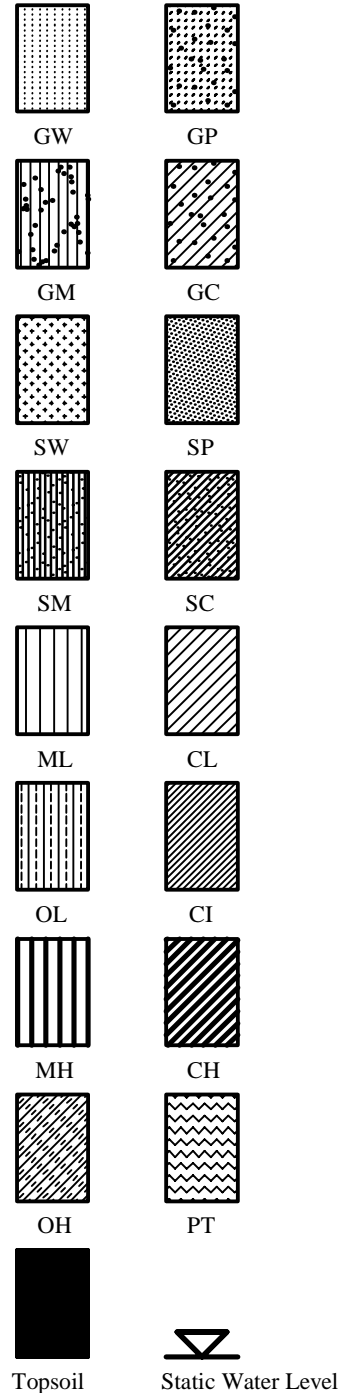
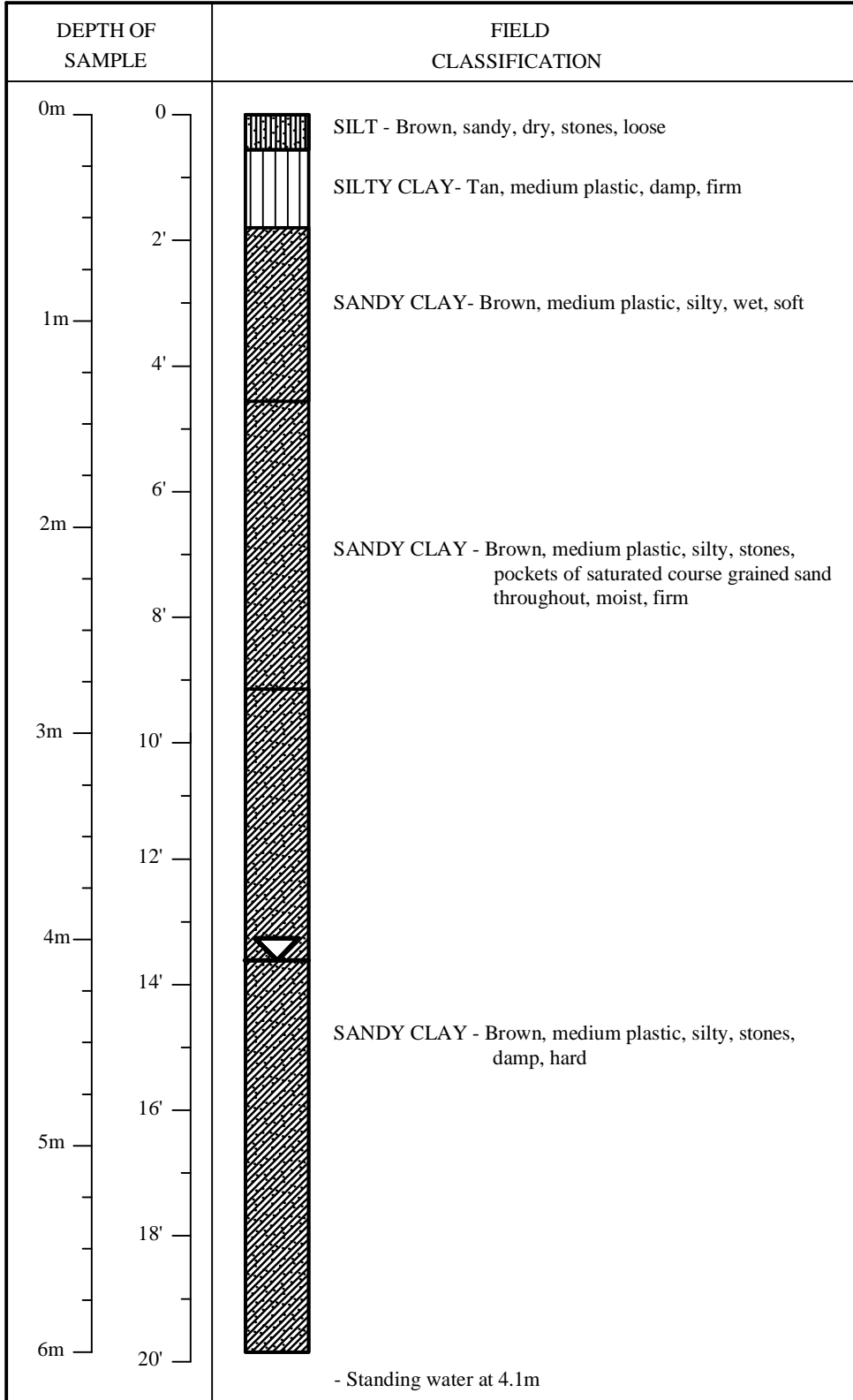

The soil logs are based upon objective data available to us at the time of forming our opinions. The soil logs indicate site specific soil characteristics and must not be generalized over larger areas due to the limited number of test holes as compared to that of an unlimited number of test holes. Every effort is made to evaluate the information by methods generally recognized. The soil represent our opinions. J.R. Cousin Consultants Ltd. cannot be responsible for actual site conditions proved to be materially at variance from our analysis or from the data generalization over untested areas.

J. R. Cousin Consultants Ltd.

TEST HOLE LOG SHEET

LOCATION : Reston Lagoon NE 5-7-27 WPM
 COORDINATES : N 5490094, E 347538
 PROJECT : Reston Lagoon Study

CODE : P-118.07
 ELEVATION : 467.263m
 METHOD OF SAMPLING : Drill Rig

DATE : August 14, 2014
 TEST HOLE # 17

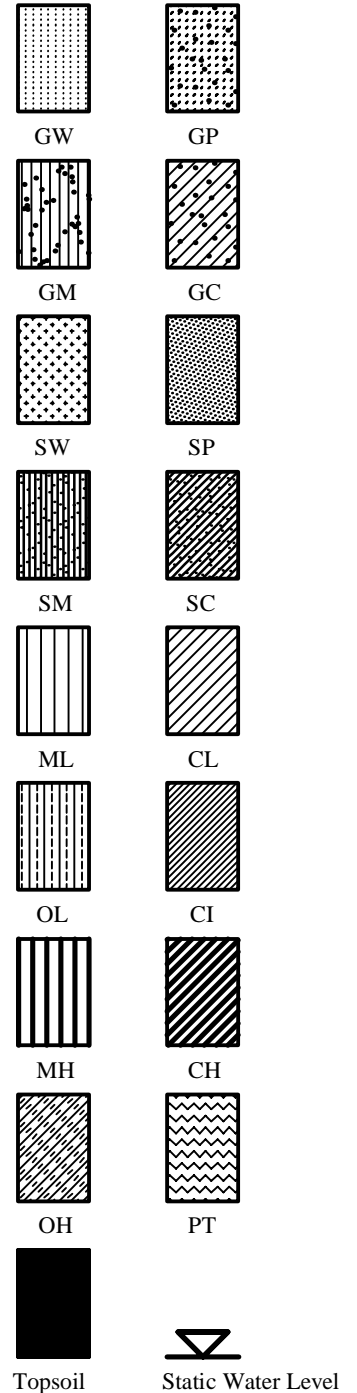
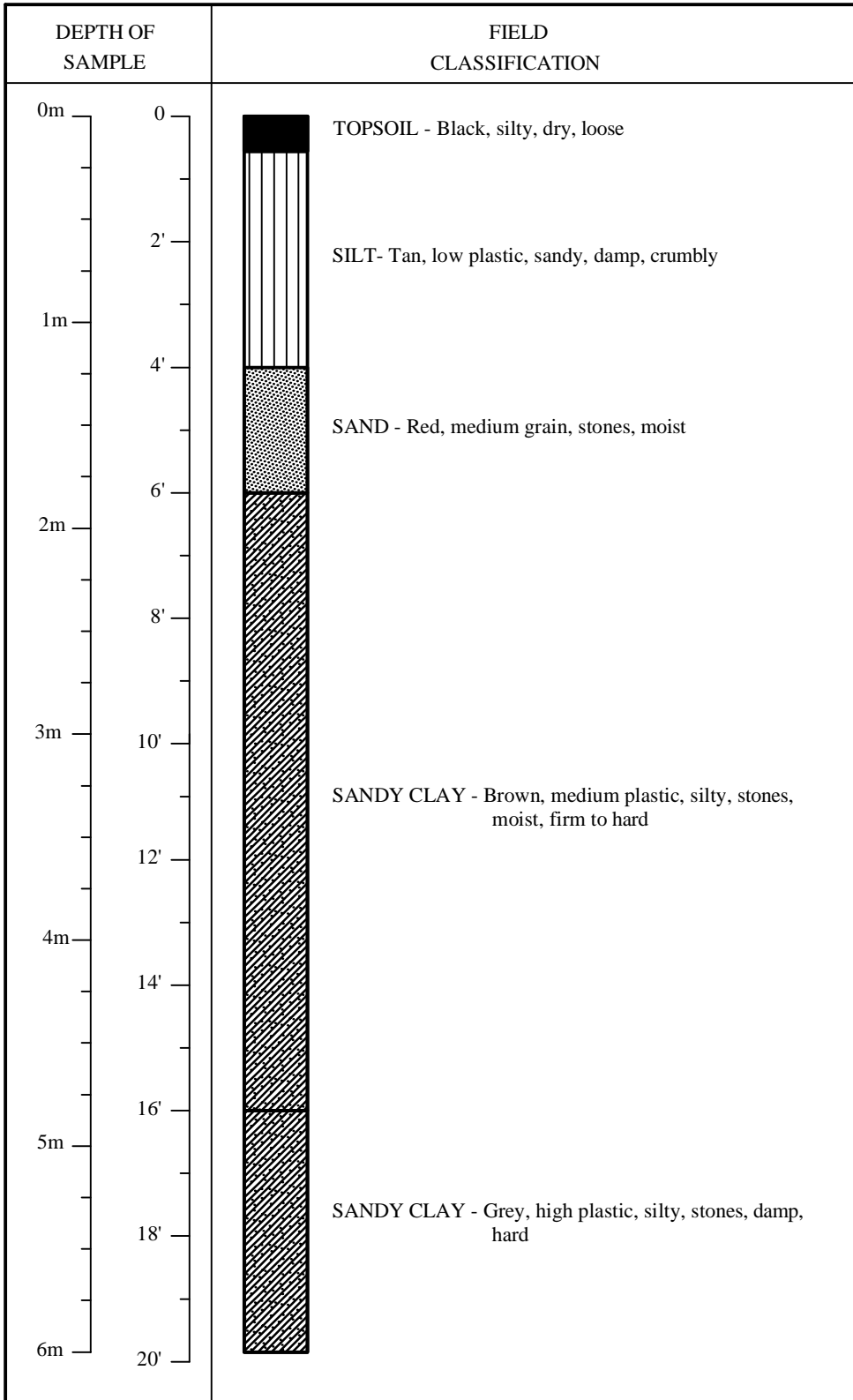

The soil logs are based upon objective data available to us at the time of forming our opinions. The soil logs indicate site specific soil characteristics and must not be generalized over larger areas due to the limited number of test holes as compared to that of a unlimited number of test holes. Every effort is made to evaluate the information by methods generally recognized. The soil represent our opinions. J.R. Cousin Consultants Ltd. cannot be responsible for actual site conditions proved to be materially at variance from our analysis or from the data generalization over untested areas.

J. R. Cousin Consultants Ltd.

TEST HOLE LOG SHEET

LOCATION : Reston Lagoon NE 5-7-27 WPM
 COORDINATES : N 5490134, E 347561
 PROJECT : Reston Lagoon Study

CODE : P-118.07
 ELEVATION : 466.406m
 METHOD OF SAMPLING : Drill Rig

DATE : August 14, 2014
 TEST HOLE # 18

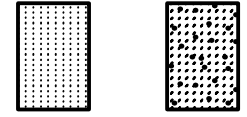
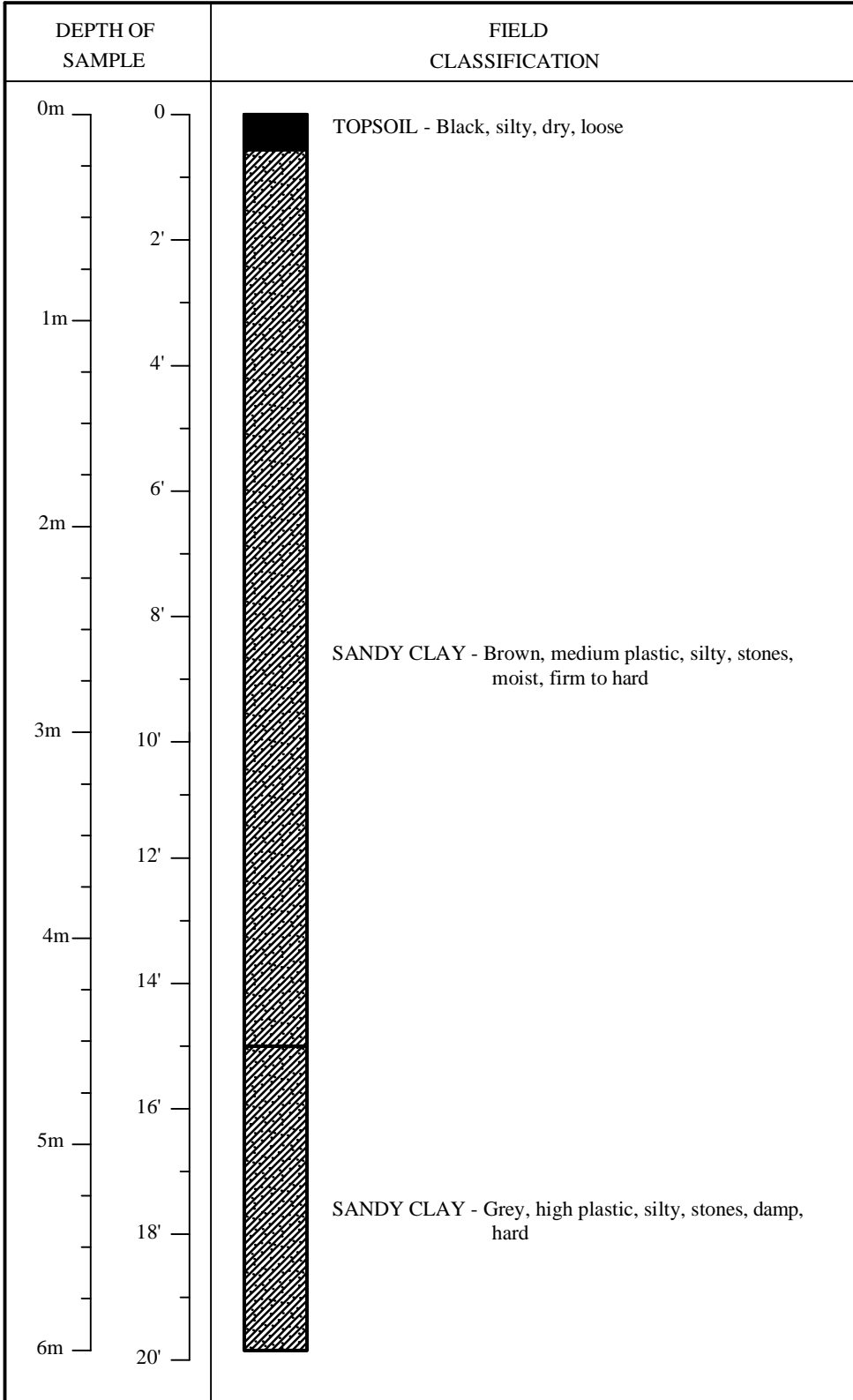

GW

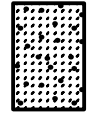

GP

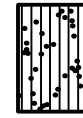

GM

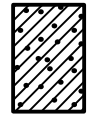

GC



SW

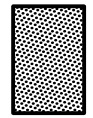

SP



SM

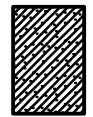

SC

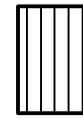

ML

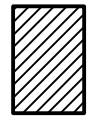

CL

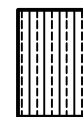

OL

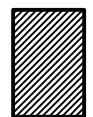

CI



MH



CH



OH

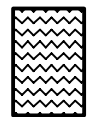

PT



Topsoil



Static Water Level

The soil logs are based upon objective data available to us at the time of forming our opinions. The soil logs indicate site specific soil characteristics and must not be generalized over larger areas due to the limited number of test holes as compared to that of a unlimited number of test holes. Every effort is made to evaluate the information by methods generally recognized. The soil represent our opinions. J.R. Cousin Consultants Ltd. cannot be responsible for actual site conditions proved to be materially at variance from our analysis or from the data generalization over untested areas.

National Testing Laboratories Ltd. Soils Analysis Report, October 11, 2013



**THE
NATIONAL
TESTING
LABORATORIES
LIMITED**
Established in 1923

199 Henlow Bay
Winnipeg, MB R3Y 1G4
Phone (204) 488-6999
Fax (204) 488-6947
Email info@nationaltestlabs.com
www.nationaltestlabs.com



J.R. Cousin Consultants Ltd.
91 A Scurfield Blvd.
Winnipeg, MB
R3Y 1G4

October 11, 2013

Attention: Oswald Wohlgemut

Project: Reston Lagoon
Investigation and Upgrade

Soil samples were submitted to our laboratory on September 26, 2013. The following tests were conducted on selected soil samples:

- water content (ASTM D2216)
- particle size analysis (ASTM D422)
- liquid limit, plastic limit, and plasticity index (ASTM D4318)
- soil classification (ASTM D2487)
- hydraulic conductivity (ASTM D5084)
- visual classification

The test results for the soil samples are summarized in the following tables and in the attached particle size analysis, Atterberg limits and hydraulic conductivity reports.

An assessment of the bagged soil samples was conducted to determine whether the soil represented by the bagged samples could be used in-situ as a lagoon liner and would obtain a hydraulic conductivity of less than 1.0×10^{-7} cm/sec without being reworked, and when re-moulded and re-compacted.

Based upon previous testing conducted in our laboratory, homogeneous soil samples with a plasticity index greater than 25 and a clay content greater than 50% will typically have a hydraulic conductivity of 1.0×10^{-7} cm/sec or less. All the bagged samples did not satisfy these criteria and are not considered suitable for use as a lagoon liner. Our comments regarding the potential use of the material as a liner are based upon the soil being homogeneous with no preferential flow paths. It should be noted that estimating the hydraulic conductivity of a soil based upon classification test results (plasticity index and particle size analysis) alone might be misleading if the soil contains layers of sand, silt, or organic material.

The hydraulic conductivity result for the Shelby tube sample TH7 at 2.4-3.0 m is more than the specified maximum hydraulic conductivity value of 1.0×10^{-7} cm/s for lagoon liners. This hydraulic conductivity result is in agreement with the criteria stated above for the bagged sample TH7 at 2.4-3.0 m. The hydraulic conductivity result for the Shelby tube sample TH9 at 0.6-1.2 m is less than the specified maximum hydraulic conductivity value of 1.0×10^{-7} cm/s for lagoon liners.

We appreciate the opportunity to assist you in this project. Please call if you have any questions regarding this report.

Farouk Fourar-Laidi, B.Sc., EIT
Geotechnical Engineering

**TABLE 1
SUMMARY OF WATER CONTENT, PARTICLE SIZE, ATTERBERG LIMITS, SOIL CLASSIFICATION TEST DATA
RESTON LAGOON INVESTIGATION AND UPGRADE**

Testhole	Depth (m)	Visual Classification	Water Content (%)	Gravel (%) 75 to 4.75 mm	Sand (%)			Silt (%) <0.075 to 0.005 mm	Clay (%) <0.005 mm	Liquid Limit	Plastic Limit	Plasticity Index	Soil Classification ASTM D2487	Potential use as a lagoon liner when re-moulded and re-compacted	Potential use as a lagoon liner without being reworked
					Coarse <4.75 to 2.0 mm	Medium <2.0 to 0.425 mm	Fine <0.425 to 0.075 mm								
TH4	0.5-4.8	brown, stiff, moist, medium plasticity silty sandy clay with trace organic material	16.3	0.0	1.4	3.0	31.7	27.3	36.6	33	14	19	CL(Sandy Lean Clay)	no	no
TH5	4.7-6.0	grey, firm, moist, medium plasticity sandy clayey silt with trace gravel and trace organic material	15.1	2.0	2.3	8.5	20.6	35.5	31.1	35	14	21	CL(Sandy Lean Clay)	no	no
TH7	2.4-3.0	brown, stiff, moist, medium plasticity clayey silty sand with trace gravel	16.0	5.8	4.0	11.4	24.3	27.7	26.8	31	13	18	CL(Sandy Lean Clay)	no	no

1. A high speed stirring device was used for 1 minute to disperse the test samples for particle size analysis.
2. Atterberg limits conducted in accordance with ASTM D4318 Method B (one-point liquid limit).
3. The soil samples were air-dried during sample preparation for Atterberg limits and particle size analysis.

**TABLE 2
SUMMARY OF HYDRAULIC CONDUCTIVITY TEST DATA
RESTON LAGOON INVESTIGATION AND UPGRADE**

Testhole	Depth (m)	Hydraulic Conductivity, "k ₂₀ "
TH7	2.4-3.0	1.3 x 10 ⁻⁶ cm/s
TH9	0.6-1.2	1.9 x 10 ⁻⁸ cm/s

PARTICLE SIZE ANALYSIS ASTM D422

J.R. Cousin Consultants Ltd.
91A Scurfield Blvd.
Winnipeg, Manitoba
R3Y 1G4

PROJECT: Reston Lagoon
Investigation and Upgrade

Attention: Oswald Wohlgemut

PROJECT NO.: JRC-1310

SAMPLED BY: Client
SAMPLE ID: TH4 at 0.5 m - 4.8 m

DATE RECEIVED: September 26, 2013
TESTED BY: Sothea Bun

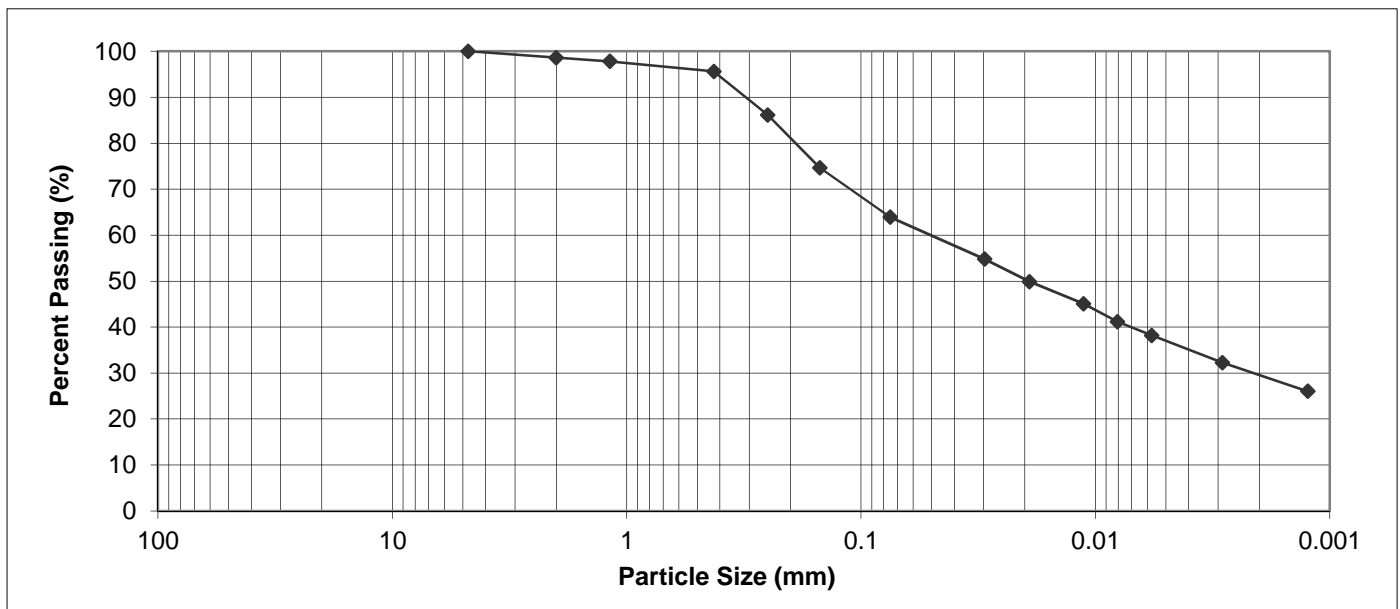

PARTICLE SIZE	PERCENT PASSING	PARTICLE SIZE	PERCENT PASSING
37.50 mm	100.0	1.18 mm	97.8
25.00 mm	100.0	0.425 mm	95.6
19.00 mm	100.0	0.250 mm	86.2
16.00 mm	100.0	0.150 mm	74.7
12.50 mm	100.0	0.075 mm	63.9
9.50 mm	100.0	0.005 mm	36.6
4.75 mm	100.0	0.002 mm	28.9
2.00 mm	98.6	0.001 mm	NT*

Gravel, % 75 to 4.75 mm	Sand, %			Silt, % <0.075 to 0.005 mm	Clay, % <0.005 mm	Colloids, % < 0.001 mm
	Coarse <4.75 to 2.0 mm	Medium <2.0 to 0.425 mm	Fine <0.425 to 0.075 mm			
0.0	1.4	3.0	31.7	27.3	36.6	NT*

NT* Sample not tested for colloids

October 11, 2013

REVIEWED BY: Farouk Fourar-Laidi, B.Sc., EIT



**THE
NATIONAL
TESTING
LABORATORIES
LIMITED**
Established in 1923

PARTICLE SIZE ANALYSIS ASTM D422

J.R. Cousin Consultants Ltd.
91A Scurfield Blvd.
Winnipeg, Manitoba
R3Y 1G4

PROJECT: Reston Lagoon
Investigation and Upgrade

Attention: Oswald Wohlgemut

PROJECT NO.: JRC-1310

SAMPLED BY: Client
SAMPLE ID: TH5 at 4.7 m - 6.0 m

DATE RECEIVED: September 26, 2013
TESTED BY: Sothea Bun

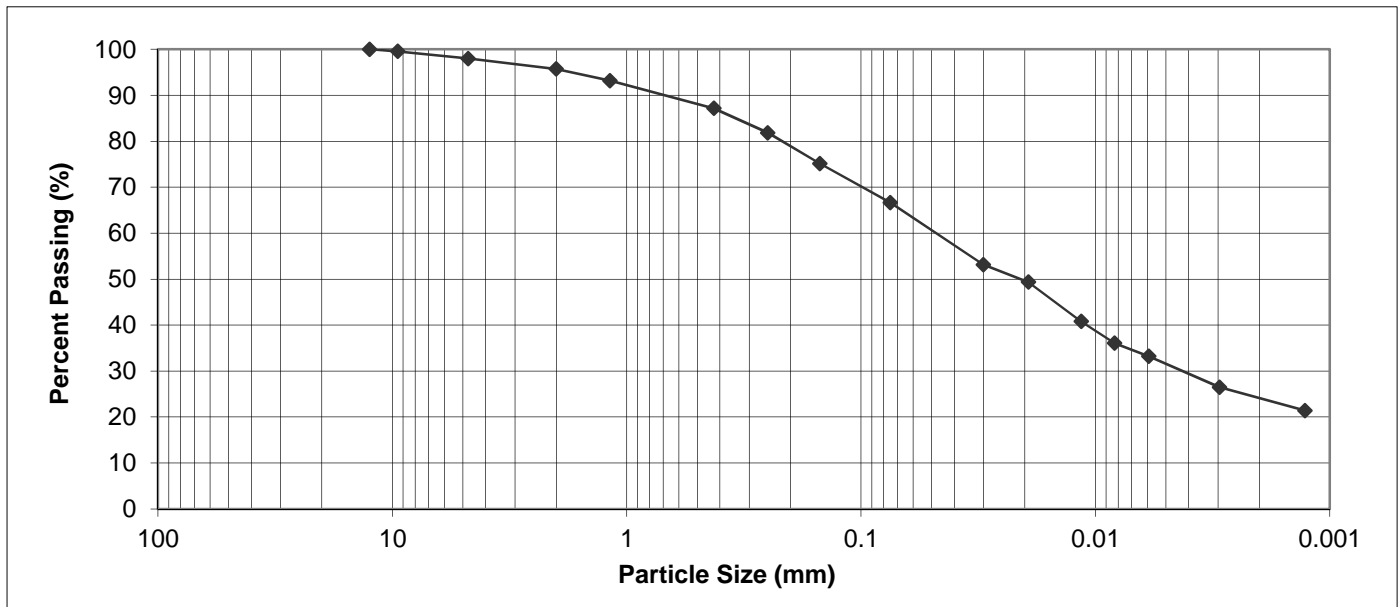

PARTICLE SIZE	PERCENT PASSING	PARTICLE SIZE	PERCENT PASSING
37.50 mm	100.0	1.18 mm	93.2
25.00 mm	100.0	0.425 mm	87.2
19.00 mm	100.0	0.250 mm	81.8
16.00 mm	100.0	0.150 mm	75.2
12.50 mm	100.0	0.075 mm	66.6
9.50 mm	99.6	0.005 mm	31.1
4.75 mm	98.0	0.002 mm	23.6
2.00 mm	95.7	0.001 mm	NT*

Gravel, % 75 to 4.75 mm	Sand, %			Silt, % <0.075 to 0.005 mm	Clay, % <0.005 mm	Colloids, % < 0.001 mm
	Coarse <4.75 to 2.0 mm	Medium <2.0 to 0.425 mm	Fine <0.425 to 0.075 mm			
2.0	2.3	8.5	20.6	35.5	31.1	NT*

NT* Sample not tested for colloids

October 11, 2013

REVIEWED BY: Farouk Fourar-Laidi, B.Sc., EIT



**THE
NATIONAL
TESTING
LABORATORIES
LIMITED**
Established in 1923

PARTICLE SIZE ANALYSIS ASTM D422

J.R. Cousin Consultants Ltd.
91A Scurfield Blvd.
Winnipeg, Manitoba
R3Y 1G4

PROJECT: Reston Lagoon
Investigation and Upgrade

Attention: Oswald Wohlgemut

PROJECT NO.: JRC-1310

SAMPLED BY: Client
SAMPLE ID: TH7 at 2.4 m - 3.0 m

DATE RECEIVED: September 26, 2013
TESTED BY: Sothea Bun

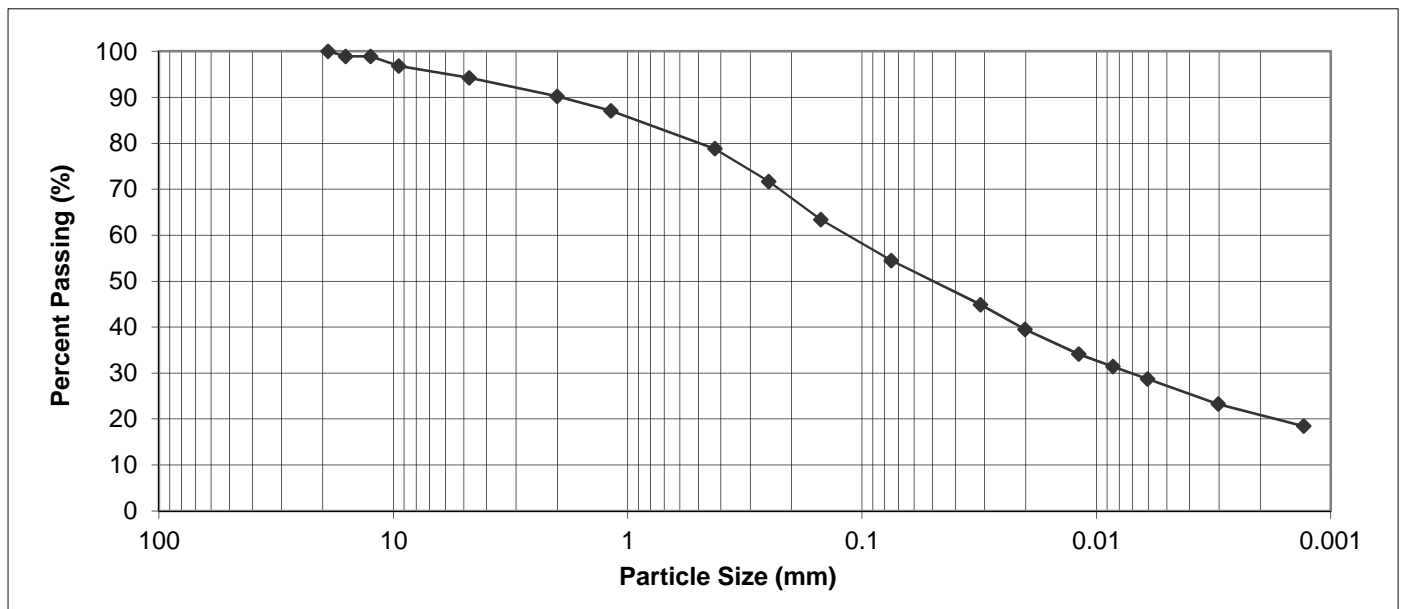

PARTICLE SIZE	PERCENT PASSING	PARTICLE SIZE	PERCENT PASSING
37.50 mm	100.0	1.18 mm	87.1
25.00 mm	100.0	0.425 mm	78.8
19.00 mm	100.0	0.250 mm	71.7
16.00 mm	98.9	0.150 mm	63.4
12.50 mm	98.9	0.075 mm	54.5
9.50 mm	96.8	0.005 mm	26.8
4.75 mm	94.2	0.002 mm	20.4
2.00 mm	90.2	0.001 mm	NT*

Gravel, % 75 to 4.75 mm	Sand, %			Silt, % <0.075 to 0.005 mm	Clay, % <0.005 mm	Colloids, % < 0.001 mm
	Coarse <4.75 to 2.0 mm	Medium <2.0 to 0.425 mm	Fine <0.425 to 0.075 mm			
5.8	4.0	11.4	24.3	27.7	26.8	NT*

NT* Sample not tested for colloids

October 11, 2013

REVIEWED BY: Farouk Fourar-Laidi, B.Sc., EIT

LIQUID LIMIT, PLASTIC LIMIT, AND PLASTICITY INDEX OF SOILS ASTM 4318

J.R. Cousin Consultants Ltd.
91A Scurfield Blvd.
Winnipeg, MB
R3Y 1G4

PROJECT: Reston Lagoon
Investigation and Upgrade

Attention: Oswald Wohlgemut

PROJECT NO.: JRC-1310

Symbol	Testhole No.	Depth (m)	Liquid Limit	Plastic Limit	Plasticity Index	USCS
u	TH4	0.5-4.8	33	14	19	CL
<	TH5	4.7-6.0	35	14	21	CL
=	TH7	2.4-3.0	31	13	18	CL

Plasticity Chart

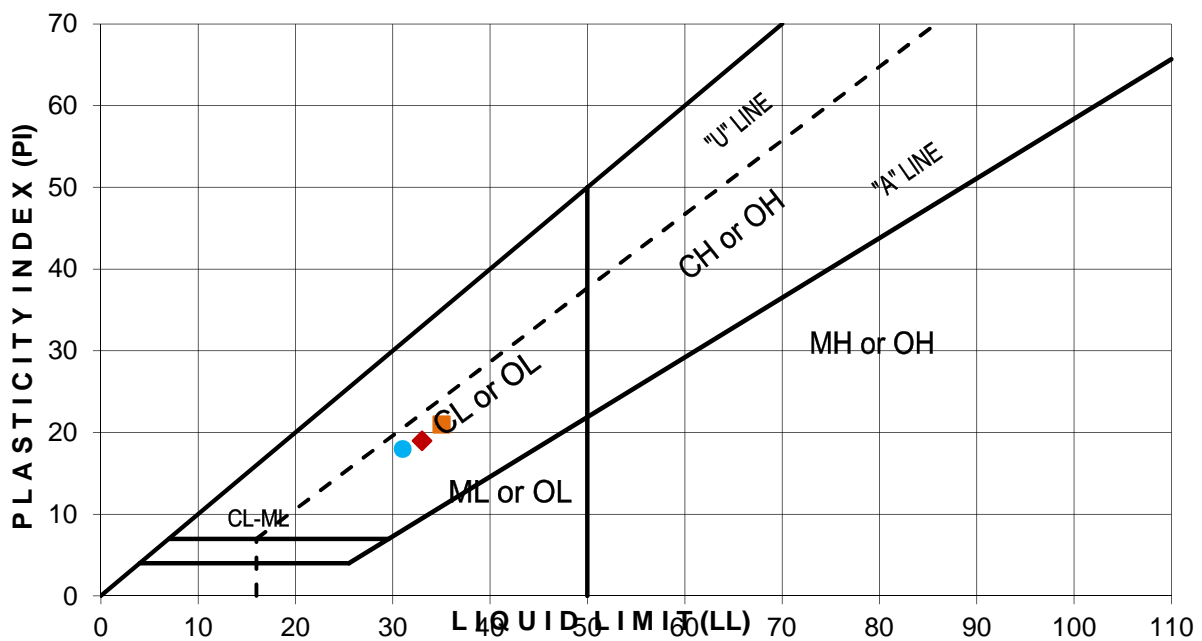

October 11, 2013

Reviewed by: Farouk Fourar-Laidi, B.Sc., EIT

HYDRAULIC CONDUCTIVITY ASTM D5084

J.R. Cousin Consultants Ltd.
91A Scurfield Blvd.
Winnipeg, MB
R3Y 1G4

PROJECT: Reston Lagoon
Investigation and Upgrade

Attention: Oswald Wohlgemut

PROJECT NO.: JRC-1310

SAMPLE I.D.: TH7 at 2.4-3.0 m
SOIL DESCRIPTION: Brown, stiff, moist, medium plasticity clayey silty sand with trace gravel
DATE TESTED: September 27 to October 8, 2013
CONFINING PRESSURE (kPa): 137.9
EFFECTIVE SATURATION STRESS (kPa): 34.5
ASSUMED SPECIFIC GRAVITY: 2.71
HYDRAULIC GRADIENT: 19.4
TYPE OF PERMEANT LIQUID: De-aired Water
HYDRAULIC CONDUCTIVITY, "k" (cm/s): 1.5E-06
HYDRAULIC CONDUCTIVITY, "k₂₀" (cm/s): 1.3E-06

	Height (mm)	Diameter (mm)	Wet Mass (g)	Dry Density (g/cm ³)	Water Content (%)	Saturation (%)
Initial Reading	77.6	72.3	671.3	1.793	17.7	93.6
Final Reading	76.5	72.3	673.2	1.825	17.4	97.4

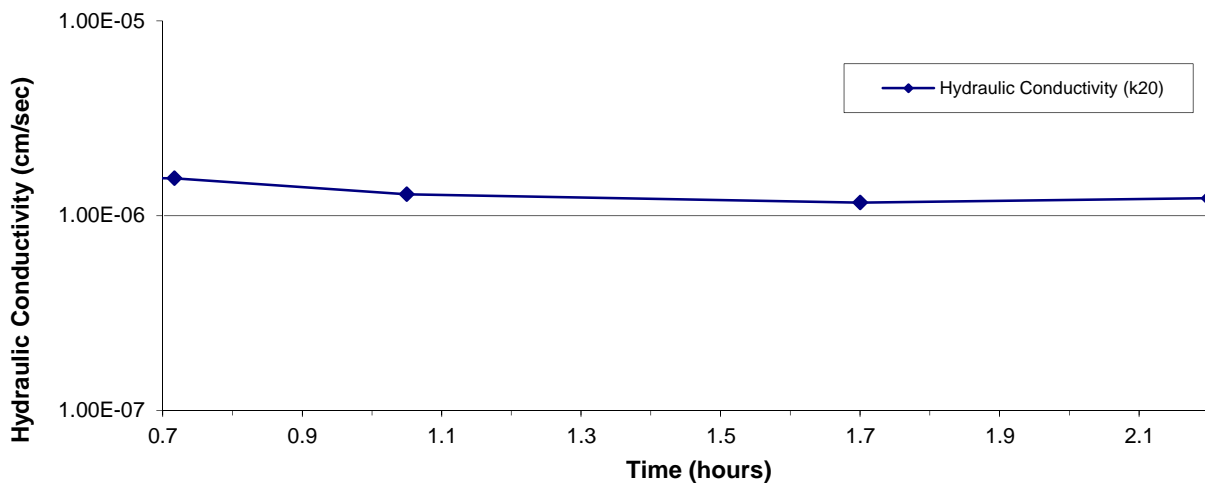

October 11, 2013

REVIEWED BY: Farouk Fourar-Laidi, B.Sc., EIT

HYDRAULIC CONDUCTIVITY ASTM D5084

J.R. Cousin Consultants Ltd.
91A Scurfield Blvd.
Winnipeg, MB
R3Y 1G4

PROJECT: Reston Lagoon
Investigation and Upgrade

Attention: Oswald Wohlgemut

PROJECT NO.: JRC-1310

SAMPLE I.D.: TH9 at 0.6-1.2 m
SOIL DESCRIPTION: Brown, stiff, moist, medium plasticity clay with some silt and some sand and trace trace gravel
DATE TESTED: October 3 to October 9, 2013
CONFINING PRESSURE (kPa): 137.9
EFFECTIVE SATURATION STRESS (kPa): 34.5
ASSUMED SPECIFIC GRAVITY: 2.71
HYDRAULIC GRADIENT: 19.9
TYPE OF PERMEANT LIQUID: De-aired Water
HYDRAULIC CONDUCTIVITY, "k" (cm/s): 2.1E-08
HYDRAULIC CONDUCTIVITY, "k₂₀" (cm/s): 1.9E-08

	Height (mm)	Diameter (mm)	Wet Mass (g)	Dry Density (g/cm ³)	Water Content (%)	Saturation (%)
Initial Reading	74.3	72.3	690.5	2.008	12.8	99.0
Final Reading	74.5	72.6	696.5	1.998	13.2	100.3

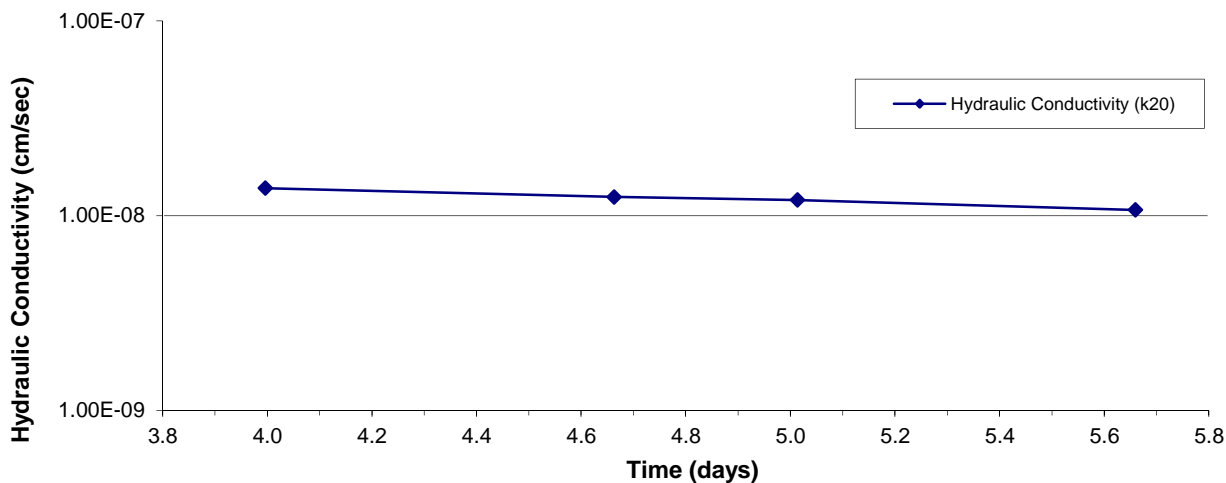

October 11, 2013

REVIEWED BY: Farouk Fourar-Laidi, B.Sc., EIT

National Testing Laboratories Ltd. Soils Analysis Report, November 8, 2013

J.R. Cousin Consultants Ltd.
91 A Scurfield Blvd.
Winnipeg, MB
R3Y 1G4

November 8, 2013

Attention: Oswald Wohlgemut

Project: Reston Lagoon
Investigation and Upgrade

A soil sample was submitted to our laboratory on October 23, 2013. The following tests were conducted on the soil sample:

- Moisture-density relationship (Proctor) of cohesive soils (ASTM D698, ASTM D1557)
- hydraulic conductivity (ASTM D5084)

The test results for the soil sample are summarized in the following table and in the attached moisture-density relationship and hydraulic conductivity reports.

Testhole	Depth (m)	Optimum Moisture Content (%)	Hydraulic Conductivity, "K ₂₀ "
TH4	0.5-4.8	17.0	5.5 x 10 ⁻⁹ cm/s

Note

The soil sample was compacted into 70 mm molds using the compactive effort outlined in standard test method ASTM D698, Method C prior to testing

An assessment of the soil sample was conducted to determine whether the soil could be used in-situ as a lagoon liner and would obtain a hydraulic conductivity of less than 1.0 x 10⁻⁷ cm/sec when re-moulded and re-compacted.

The sample TH4 at 0.5-4.8 m was re-worked and re-compacted to 97% of the Standard Proctor Density. The hydraulic conductivity result for the re-compacted sample was 5.5 x 10⁻⁹ cm/s which is less than the specified maximum hydraulic conductivity value of 1.0 x 10⁻⁷ cm/s for lagoon liners.

Based on the test result the soil sample TH4 at 0.5-4.8 m is considered suitable to be used as a lagoon liner when re-moulded and re-compacted.

We appreciate the opportunity to assist you in this project. Please call if you have any questions regarding this report.



Farouk Fourar-Laidi, B.Sc., EIT
Geotechnical Engineering

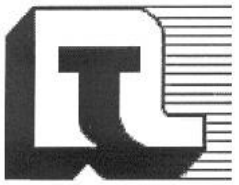

PROCTOR TEST REPORT

TO
J.R. Cousin Consultants Ltd.
91A Scurfield Blvd.
Winnipeg, MB
R3Y 1G4

CLIENT J.R. Cousin Consultants Ltd.
C.C.

ATTN: Oswald Wohlgemut

PROJECT Reston Lagoon Investigation & Upgrade

PROCTOR NO. 1

NTL PROJECT NO. JRC-1310

DATE SAMPLED	2013.Oct.22	DATE RECEIVED	2013.Oct.23
SAMPLED BY	J.R. Cousin	DATE TESTED	2013.Oct.25
MATERIAL IDENTIFICATION		COMPACTION STANDARD	Standard Proctor, ASTM D698
MATERIAL USE	Lagoon Liner	COMPACTION PROCEDURE	A: 101.6mm Mold, Passing 4.75mm
MAX. NOMINAL SIZE		OVERSIZE CORRECTION METHOD	None
MATERIAL TYPE	Clay	RETAINED 4.75mm SCREEN	
SUPPLIER			
SOURCE	Existing Material		

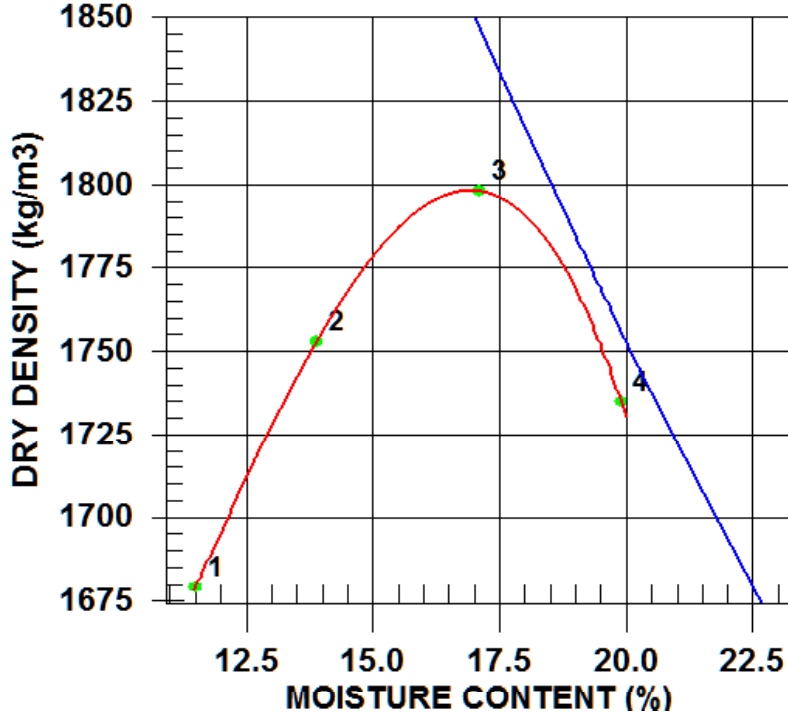

TRIAL NUMBER	WET DENSITY (kg/m ³)	DRY DENSITY (kg/m ³)	MOISTURE CONTENT (%)
1	1872	1679	11.5
2	1997	1753	13.9
3	2105	1798	17.1
4	2080	1735	19.9

	MAXIMUM DRY DENSITY (kg/m ³)	OPTIMUM MOISTURE CONTENT (%)
CALCULATED OVERSIZE CORRECTED	1798	17.0

COMMENTS

Material tested was identified as being sampled from TH4, 0.5 to 4.8 m.

HYDRAULIC CONDUCTIVITY ASTM D5084

J.R. Cousin Consultants Ltd.
91A Scurfield Blvd.
Winnipeg, MB
R3Y 1G4

PROJECT: Reston Lagoon
Investigation and Upgrade

Attention: Oswald Wohlgemut

PROJECT NO.: JRC-1310

SAMPLE I.D.: TH4 at 0.5-4.8 m
SOIL DESCRIPTION: Brown, firm, moist, high plasticity clay
 trace fine gravel
DATE TESTED: October 30 to November 7, 2013
CONFINING PRESSURE (kPa): 137.9
EFFECTIVE SATURATION STRESS (kPa): 34.5
ASSUMED SPECIFIC GRAVITY: 2.71
HYDRAULIC GRADIENT: 20.1
TYPE OF PERMEANT LIQUID: De-aired Water
HYDRAULIC CONDUCTIVITY, "k" (cm/s): 5.9E-09
HYDRAULIC CONDUCTIVITY, "k₂₀" (cm/s): 5.5E-09

	Height (mm)	Diameter (mm)	Wet Mass (g)	Dry Density (g/cm ³)	Water Content (%)	Saturation (%)
Initial Reading	74.2	70.9	621.5	1.809	17.2	93.6
Final Reading	73.7	71.3	625.0	1.796	18.2	96.7

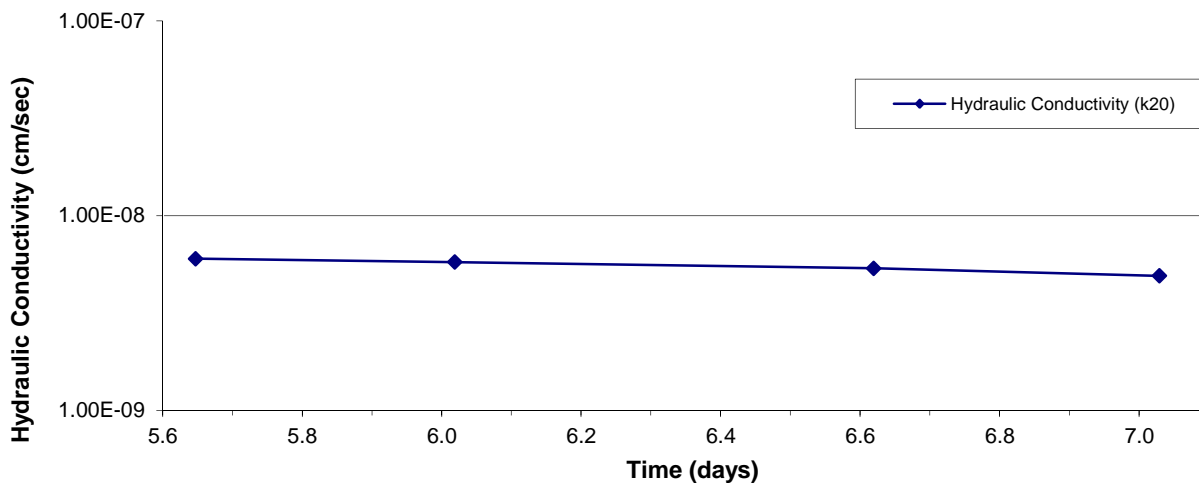

Note: Sample was compacted into 70 mm mold using the compactive effort outlined in standard test method ASTM D698, Method C prior to testing

November 8, 2013

REVIEWED BY: Farouk Fourar-Laidi, B.Sc., EIT

Stantec Consulting Ltd. Soils Analysis Report, August 28, 2014



Stantec Consulting Ltd.
199 Henlow Bay, Winnipeg MB R3Y 1G4

August 28, 2014
File: 123311472

Attention: Mr. Oswald Wohlgemut

JR Cousin Consultants Ltd.
91A Scurfield Blvd.
Winnipeg, MB R3Y 1G4

Dear Oswald,

Reference: Reston Lagoon Upgrade/Expansion

Soil samples were submitted to our laboratory on August 22, 2014. The following tests were conducted on selected soil samples:

- Water content (ASTM D2216)
- Particle-Size Analysis (ASTM D422)
- Liquid Limit (one-point), plastic limit, and plasticity index (ASTM D4318)
- Soil Classification (ASTM D2487)
- Visual Classification

The test results for the soil samples are summarized in the following table and in the attached particle size analysis and Atterberg limits reports.

An assessment of the bagged soil samples was conducted to determine whether the soil represented by the bagged samples could be used in-situ as a lagoon liner and would obtain a permeability of less than 1.0×10^{-7} cm/sec without being reworked, and when re-moulded and re-compacted.

Based upon previous testing conducted in our laboratory, homogeneous soil samples with a plasticity index greater than 25 and a clay content greater than 50% will typically have a hydraulic conductivity of 1.0×10^{-7} cm/sec or less. All bagged samples did not fall within this range and considered not suitable to use as a lagoon liner. Our comments regarding the potential use of the material as a liner are based upon the soil being homogeneous with no preferential flow paths. It should be noted that estimating the hydraulic conductivity of a soil based upon classification test results (plasticity index and particle size analysis) alone might be misleading if the soil contains layers of sand, silt, or organic material.



August 28, 2014
Mr. Oswald Wohlgemut
Page 2 of 3

Reference: Reston Lagoon Upgrade/Expansion

We appreciate the opportunity to assist you in this project. Please call if you have any questions regarding this report.

Regards,

STANTEC CONSULTING LTD.

Jason Thompson, CET
Associate - Manager, Materials Testing Services
Phone: (204) 928-4004
Fax: (204) 488-6947
Jason.Thompson@stantec.com

Attachment: Table 1 – Summary of Water Content, Particle Size, Atterberg Limits, Soil
Classification Test Data
4 x Particle Size Analysis Report
2 x Atterberg Limits Report

TABLE 1
SUMMARY OF WATER CONTENT, PARTICLE SIZE, ATTERBERG LIMITS, SOIL CLASSIFICATION
TEST DATA

Testhole	Depth (m)	Visual Classification	Water Content (%)	Gravel (%) 75 to 4.75 mm	Sand (%)			Silt (%) <0.075 to 0.005 mm	Clay (%) <0.005 mm	Liquid Limit	Plastic Limit	Plasticity Index	Soil Classification ASTM D2487	Potential use as a lagoon liner when re-moulded and re-compacted	Potential use as a lagoon liner without being reworked
					Coarse <4.75 to 2.0 mm	Medium <2.0 to 0.425 mm	Fine <0.425 to 0.075 mm								
TH10	0-0.2	black, firm, moist, medium plasticity silty sand, clayey with trace gravel	22.9	4.3	2.8	12.1	24.8	29.7	26.3	45	19	26	CL(Sandy Lean Clay)	No	No
TH10	0.2-4.5	brown, firm, moist, medium plasticity silty sand, clayey with trace gravel	19.8	2.6	3.0	10.3	24.7	30.5	28.9	36	14	22	CL(Sandy Lean Clay)	No	No
TH12	0.4-2.5	brown, firm, moist, medium plasticity sandy silt, clayey with trace gravel	20.4	2.7	2.2	8.1	23.5	36.1	27.4	32	15	17	CL(Sandy Lean Clay)	No	No
TH16	0.4-1.4	brown, firm, moist, medium plasticity silty clay, sandy with trace gravel	20.5	6.0	2.4	7.4	20.4	30.7	33.1	38	16	22	CL(Sandy Lean Clay)	No	No

Notes:

1. The soil samples were air-dried during sample preparation for Atterberg limits and particle size analysis
2. A high speed stirring device was used for 1 minute to disperse the test samples for particle size analysis
3. Atterberg limits conducted in accordance with ASTM D4318 Method B (one-point liquid limit)



LABORATORY
 199 Henlow Bay
 Winnipeg MB R3Y 1G4
 Tel: (204) 488-6999

PARTICLE SIZE ANALYSIS
ASTM D422

JR Cousin Consultants Ltd.
 91A Scurfield Boulevard
 Winnipeg, Manitoba
 R3Y 1G4

PROJECT: Reston Lagoon Upgrade/
 Expansion

Attention: Oswald Wohlgemut

PROJECT NO.: 123311472

SAMPLED BY: Client
 SAMPLE ID: TH12 @ 0.4 - 2.5 m

DATE RECEIVED: August 22, 2014
 TESTED BY: Nestor Abarca

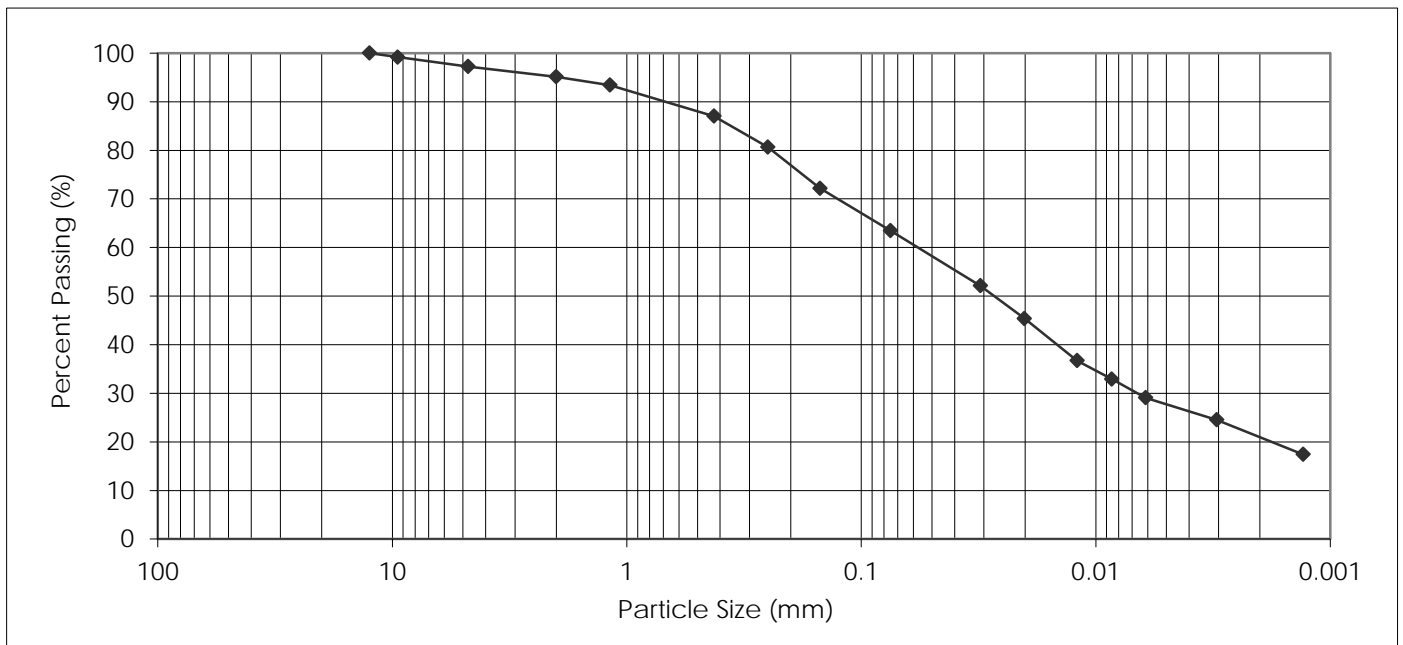

PARTICLE SIZE		PERCENT PASSING		PARTICLE SIZE		PERCENT PASSING	
37.50 mm		100.0		1.18 mm		93.4	
25.00 mm		100.0		0.425 mm		87.0	
19.00 mm		100.0		0.250 mm		80.6	
16.00 mm		100.0		0.150 mm		72.2	
12.50 mm		100.0		0.075 mm		63.5	
9.50 mm		99.2		0.005 mm		27.4	
4.75 mm		97.3		0.002 mm		20.3	
2.00 mm		95.1		0.001 mm		NT*	
Gravel, % 75 to 4.75 mm	Sand, %			Silt, % <0.075 to 0.005 mm	Clay, % <0.005 mm	Colloids, % < 0.001 mm	
	Coarse <4.75 to 2.0 mm	Medium <2.0 to 0.425 mm	Fine <0.425 to 0.075 mm				
2.7	2.2	8.1	23.5	36.1	27.4	NT*	

NT* Sample not tested for colloids

August 28, 2014

REVIEWED BY:  Jason Thompson, CET



LABORATORY
 199 Henlow Bay
 Winnipeg MB R3Y 1G4
 Tel: (204) 488-6999

PARTICLE SIZE ANALYSIS
ASTM D422

JR Cousin Consultants Ltd.
 91A Scurfield Boulevard
 Winnipeg, Manitoba
 R3Y 1G4

PROJECT: Reston Lagoon Upgrade/
 Expansion

Attention: Oswald Wohlgemut

PROJECT NO.: 123311472

SAMPLED BY: Client
 SAMPLE ID: TH16 @ 0.4 - 1.4 m

DATE RECEIVED: August 22, 2014
 TESTED BY: Nestor Abarca

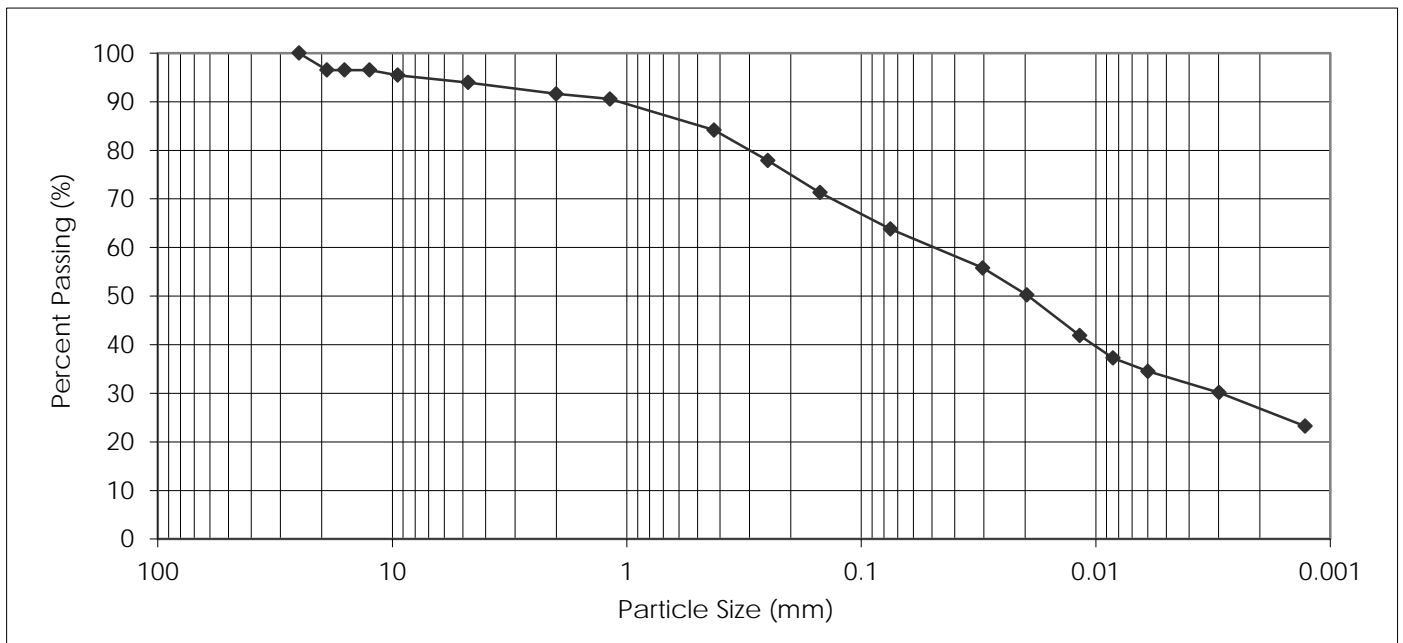

PARTICLE SIZE	PERCENT PASSING
37.50 mm	100.0
25.00 mm	100.0
19.00 mm	96.5
16.00 mm	96.5
12.50 mm	96.5
9.50 mm	95.5
4.75 mm	94.0
2.00 mm	91.6

PARTICLE SIZE	PERCENT PASSING
1.18 mm	90.5
0.425 mm	84.2
0.250 mm	77.9
0.150 mm	71.3
0.075 mm	63.8
0.005 mm	33.1
0.002 mm	26.2
0.001 mm	NT*

Gravel, % 75 to 4.75 mm	Sand, %			Silt, % <0.075 to 0.005 mm	Clay, % <0.005 mm	Colloids, % < 0.001 mm
	Coarse <4.75 to 2.0 mm	Medium <2.0 to 0.425 mm	Fine <0.425 to 0.075 mm			
6.0	2.4	7.4	20.4	30.7	33.1	NT*

NT* Sample not tested for colloids

August 28, 2014

REVIEWED BY:  Jason Thompson, CET



LABORATORY
 199 Henlow Bay
 Winnipeg MB R3Y 1G4
 Tel: (204) 488-6999

PARTICLE SIZE ANALYSIS
ASTM D422

JR Cousin Consultants Ltd.
 91A Scurfield Boulevard
 Winnipeg, Manitoba
 R3Y 1G4

PROJECT: Reston Lagoon Upgrade/
 Expansion

Attention: Oswald Wohlgemut

PROJECT NO.: 123311472

SAMPLED BY: Client
 SAMPLE ID: TH10 @ 0.2 - 4.5 m

DATE RECEIVED: August 22, 2014
 TESTED BY: Nestor Abarca

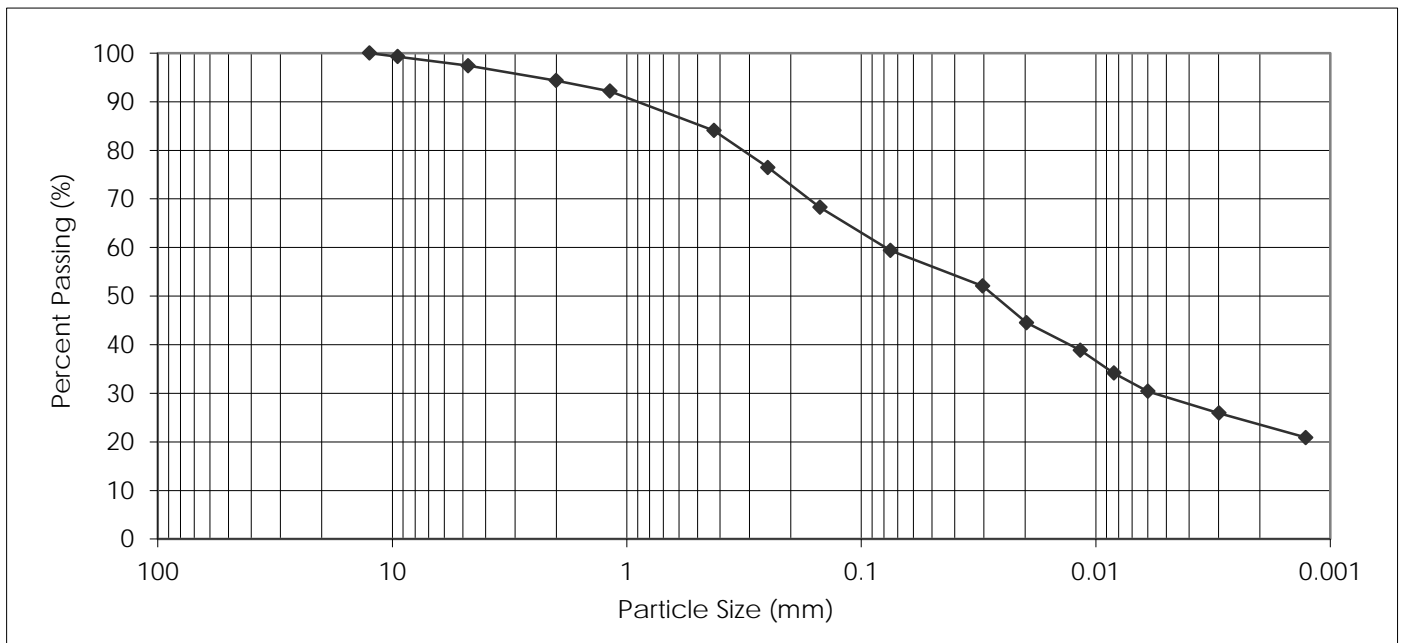

PARTICLE SIZE	PERCENT PASSING	PARTICLE SIZE	PERCENT PASSING
37.50 mm	100.0	1.18 mm	92.2
25.00 mm	100.0	0.425 mm	84.1
19.00 mm	100.0	0.250 mm	76.5
16.00 mm	100.0	0.150 mm	68.3
12.50 mm	100.0	0.075 mm	59.4
9.50 mm	99.3	0.005 mm	28.9
4.75 mm	97.4	0.002 mm	23.0
2.00 mm	94.4	0.001 mm	NT*

Gravel, % 75 to 4.75 mm	Sand, %			Silt, % <0.075 to 0.005 mm	Clay, % <0.005 mm	Colloids, % < 0.001 mm
	Coarse <4.75 to 2.0 mm	Medium <2.0 to 0.425 mm	Fine <0.425 to 0.075 mm			
2.6	3.0	10.3	24.7	30.5	28.9	NT*

NT* Sample not tested for colloids

August 28, 2014

REVIEWED BY:  Jason Thompson, CET



LABORATORY
 199 Henlow Bay
 Winnipeg MB R3Y 1G4
 Tel: (204) 488-6999

PARTICLE SIZE ANALYSIS
ASTM D422

JR Cousin Consultants Ltd.
 91A Scurfield Boulevard
 Winnipeg, Manitoba
 R3Y 1G4

PROJECT: Reston Lagoon Upgrade/
 Expansion

Attention: Oswald Wohlgemut

PROJECT NO.: 123311472

SAMPLED BY: Client
 SAMPLE ID: TH10 @ 0.0 - 0.2 m

DATE RECEIVED: August 22, 2014
 TESTED BY: Nestor Abarca

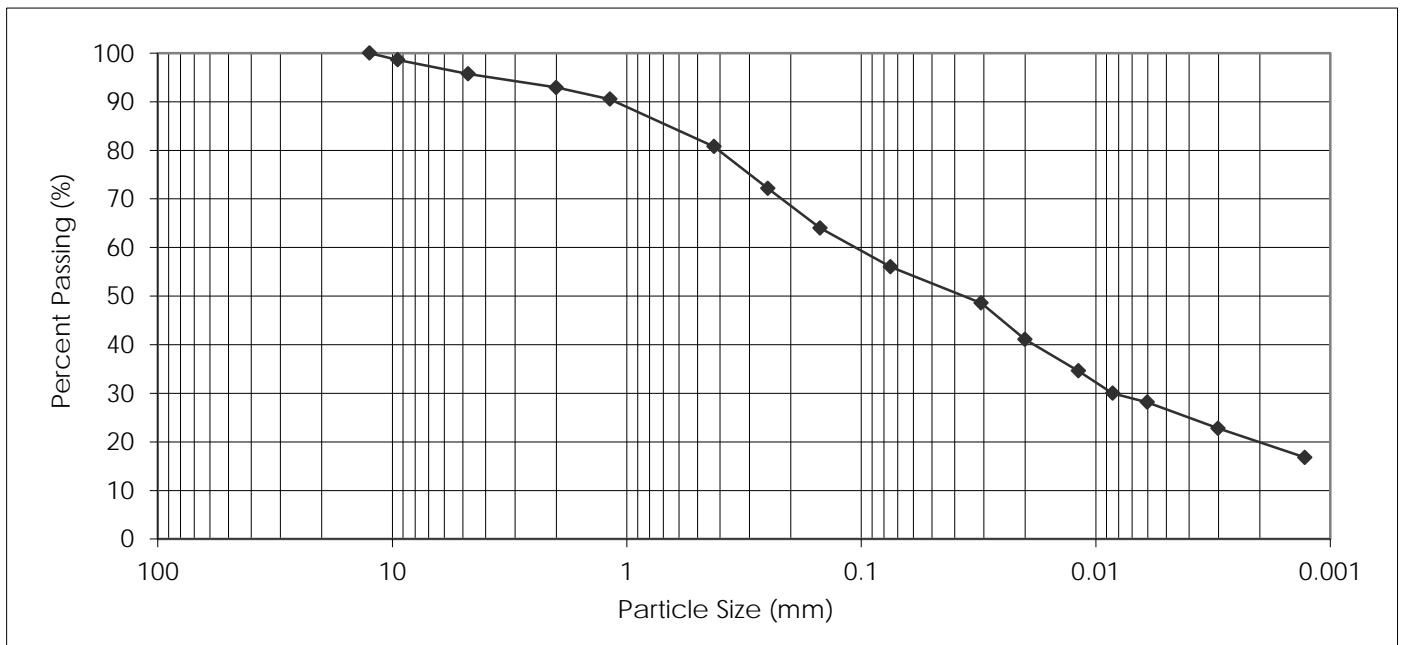

PARTICLE SIZE		PERCENT PASSING		PARTICLE SIZE		PERCENT PASSING	
37.50 mm		100.0		1.18 mm		90.5	
25.00 mm		100.0		0.425 mm		80.8	
19.00 mm		100.0		0.250 mm		72.2	
16.00 mm		100.0		0.150 mm		64.0	
12.50 mm		100.0		0.075 mm		56.0	
9.50 mm		98.6		0.005 mm		26.3	
4.75 mm		95.7		0.002 mm		19.3	
2.00 mm		92.9		0.001 mm		NT*	
Gravel, % 75 to 4.75 mm	Sand, %			Silt, % <0.075 to 0.005 mm	Clay, % <0.005 mm	Colloids, % < 0.001 mm	
	Coarse <4.75 to 2.0 mm	Medium <2.0 to 0.425 mm	Fine <0.425 to 0.075 mm				
4.3	2.8	12.1	24.8	29.7	26.3	NT*	

NT* Sample not tested for colloids

August 28, 2014

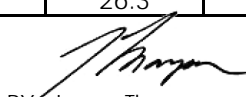
REVIEWED BY:  Jason Thompson, CET



Atterberg Limits
 ASTM D4318
 Method B- One Point

Client: JR Cousin Consultants Ltd.
 Project Name: Reston Lagoon Upgrade/Expansion
 Project No: 123311472
 Date Received: August 22, 2014
 Date Tested: August 26, 2014
 Tested By: Larry Presado

LABORATORY
 199 Henlow Bay
 Winnipeg, Manitoba
 Canada R3Y 1G4

Tel: (204) 488-6999

Sample:		Sample:	
TH12 @ 0.4 - 2.5m		TH16 @ 0.4 - 1.4m	
LIQUID		LIQUID	
1	2	Trial No.	
25	23	Number of Blows	24 22
402	453	Container Number	514 479
49.11	59.94	Wt. Sample (wet+tare)(g)	54.90 51.96
42.90	52.42	Wt. Sample (dry+tare)(g)	47.03 45.16
23.70	29.18	Wt. Tare (g)	26.60 27.07
19.2	23.2	Wt. Dry Soil (g)	20.4 18.1
6.2	7.5	Wt. Water (g)	7.9 6.8
32.3%	32.4%	Water Content (%)	38.5% 37.6%
32.3%	32.0%	Corrected Water Content (%)	38.3% 37.0%
PLASTIC		PLASTIC	
1	2	Trial No.	
600	474	Container Number	540 541
37.44	37.57	Wt. Sample (wet+tare)(g)	38.27 36.43
35.58	36.17	Wt. Sample (dry+tare)(g)	36.45 34.68
23.29	26.41	Wt. Tare (g)	25.16 23.83
12.3	9.8	Wt. Dry Soil (g)	11.3 10.9
1.9	1.4	Wt. Water (g)	1.8 1.8
15.1%	14.3%	Water Content (%)	16.1% 16.1%
AVERAGE VALUES		AVERAGE VALUES	
1	2	1	2
LL	32	LL	38
PL	15	PL	16
PI	18	PI	22
CLASSIFICATION		CLASSIFICATION	
CL		CL	

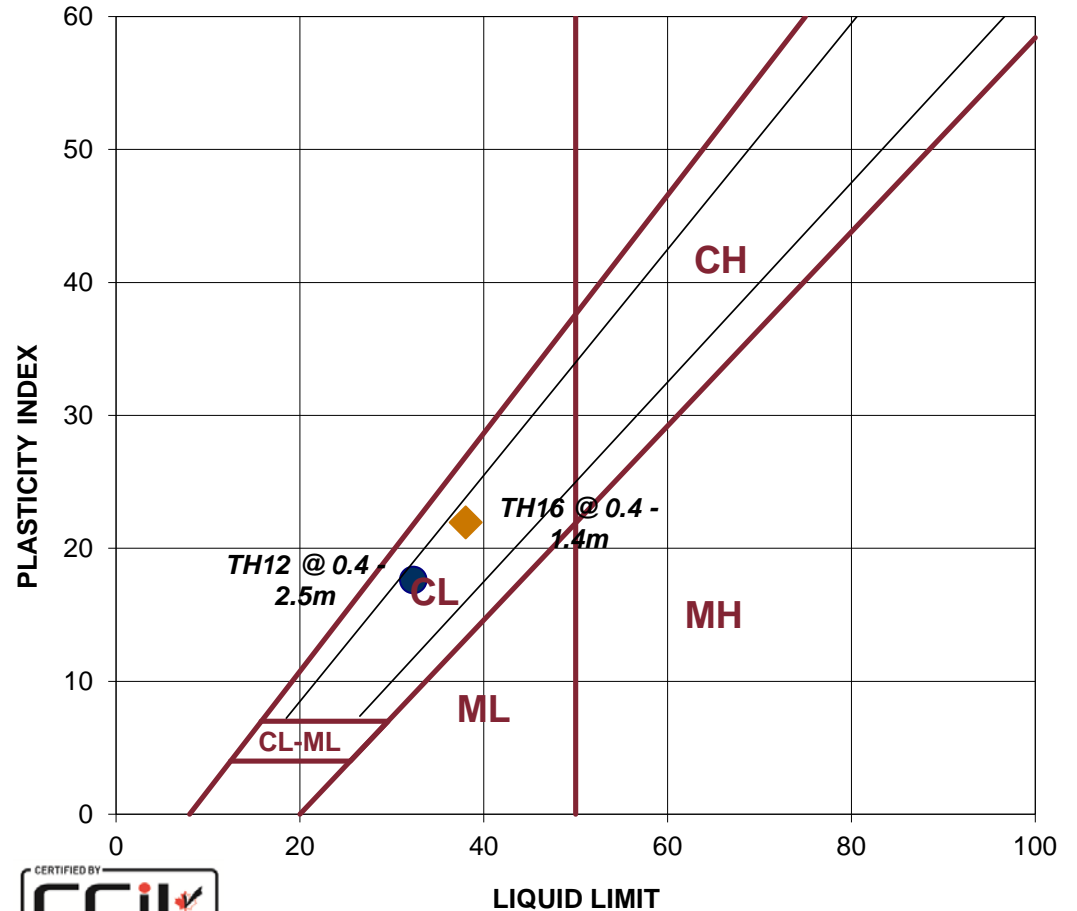

Reporting of these test results constitutes a testing service only. Engineering interpretation or evaluation of the test results is provided only on written request. The data presented above is for the sole use of the client stipulated above. STANTEC is not responsible, nor can be held liable, for the use of this report by any other party, with or without the knowledge of STANTEC.

Reviewed By: Jason Thompson, CET



Atterberg Limits
 ASTM D4318
 Method B- One Point

Client: JR Cousin Consultants Ltd.
 Project Name: Reston Lagoon Upgrade/Expansion
 Project No: 123311472
 Date Received: August 22, 2014
 Date Tested: August 26, 2014
 Tested By: Larry Presado

LABORATORY
 199 Henlow Bay
 Winnipeg, Manitoba
 Canada R3Y 1G4

Tel: (204) 488-6999

Sample:		Sample:	
TH10 @ 0.0 - 0.2m		TH10 @ 0.2 - 4.5m	
LIQUID		LIQUID	
1	2	Trial No.	
24	27	Number of Blows	27 27
427	506	Container Number	432 537
51.17	50.39	Wt. Sample (wet+tare)(g)	47.21 46.88
42.87	42.81	Wt. Sample (dry+tare)(g)	40.15 40.63
24.62	26.01	Wt. Tare (g)	20.45 23.19
18.3	16.8	Wt. Dry Soil (g)	19.7 17.4
8.3	7.6	Wt. Water (g)	7.1 6.3
45.5%	45.1%	Water Content (%)	35.8% 35.8%
45.3%	45.5%	Corrected Water Content (%)	36.2% 36.2%
PLASTIC		PLASTIC	
1	2	Trial No.	
451	480	Container Number	471 458
36.88	36.73	Wt. Sample (wet+tare)(g)	35.66 39.5
35.1	34.46	Wt. Sample (dry+tare)(g)	34.09 38.09
25.7	22.54	Wt. Tare (g)	22.68 27.45
9.4	11.9	Wt. Dry Soil (g)	11.4 10.6
1.8	2.3	Wt. Water (g)	1.6 1.4
18.9%	19.0%	Water Content (%)	13.8% 13.3%
AVERAGE VALUES		AVERAGE VALUES	
1	2	1	2
LL	45	LL	36
PL	19	PL	14
PI	26	PI	22
CLASSIFICATION		CLASSIFICATION	
CL		CL	

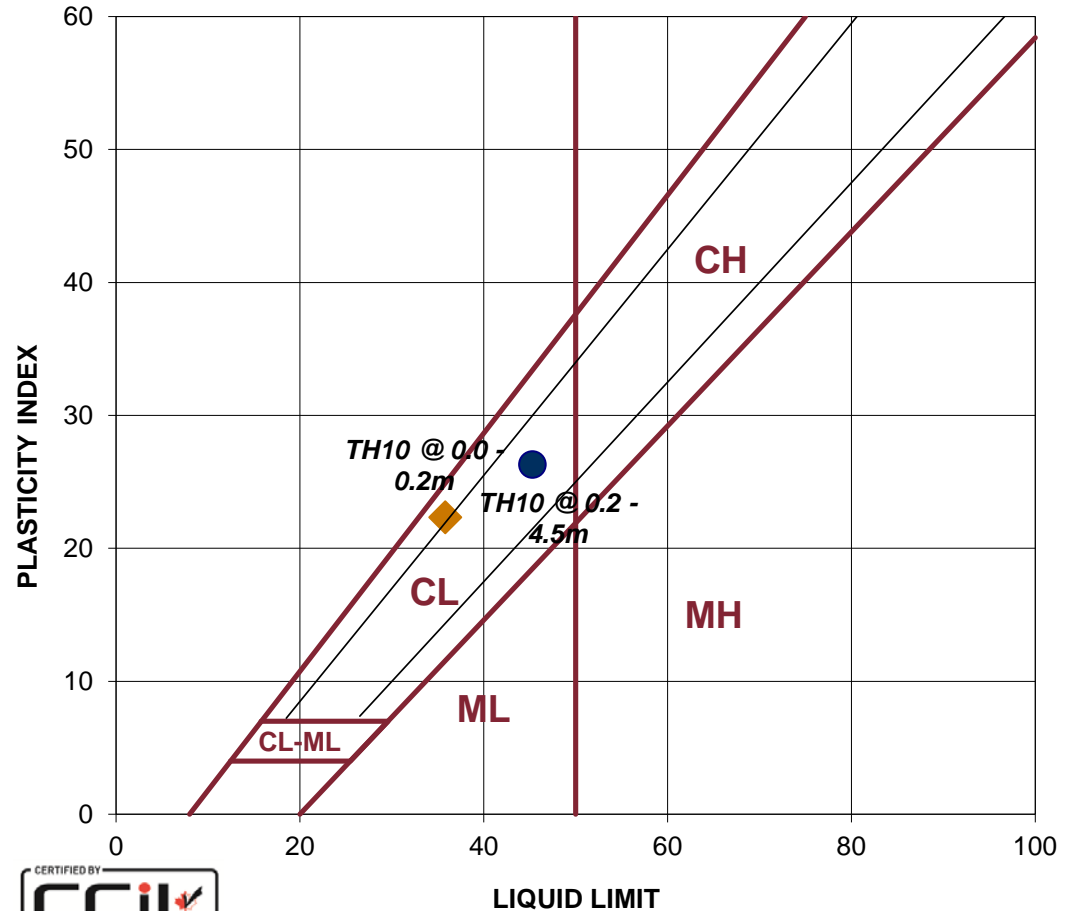

Reporting of these test results constitutes a testing service only. Engineering interpretation or evaluation of the test results is provided only on written request. The data presented above is for the sole use of the client stipulated above. STANTEC is not responsible, nor can be held liable, for the use of this report by any other party, with or without the knowledge of STANTEC.

Reviewed By: Jason Thompson, CET

Stantec Consulting Ltd. Soils Analysis Report, October 6, 2014

October 6, 2014
File: 123311472

Attention: Oswald Wohlgemut

J.R. Cousin Consultants Ltd.
91A Scurfield Blvd.
Winnipeg, MB R3Y 1G4

Dear Oswald,

Reference: Reston Lagoon Expansion

A soil sample was submitted to our laboratory on September 4, 2014. The following tests were conducted on the soil sample:

- Moisture-density relationship (Proctor) of cohesive soils (ASTM D698)
- hydraulic conductivity (ASTM D5084)

The test results for the soil sample are summarized in the following table and in the attached moisture-density relationship and hydraulic conductivity reports

Testhole ID	Testhole Depth (m)	Optimum Moisture Content (%)	Hydraulic Conductivity, "k ₂₀ "
TH10	0.2-4.5	15.0	1.2 x 10 ⁻⁸ cm/s

Note: Note: Sample was compacted into 70 mm mold using the compactive effort outlined in standard test method ASTM D698, Method C prior to testing

An assessment of the soil sample was conducted to determine whether the soil could be used in-situ as a lagoon liner and would obtain a hydraulic conductivity of less than 1.0 x 10⁻⁷ cm/sec when re-moulded and re-compacted.

The sample TH10 at 0.2-4.5 m was re-worked and re-compacted to 96% of the Standard Proctor Density. The hydraulic conductivity result for the re-compacted sample was 1.2 x 10⁻⁸ cm/s which is less than the specified maximum hydraulic conductivity value of 1.0 x 10⁻⁷ cm/s for lagoon liners.

Based on the test result the soil sample TH10 at 0.2-4.5 m is considered suitable to be used as a lagoon liner when re-moulded and re-compacted.



October 6, 2014
Page 2 of 2

Reference: Reference

We appreciate the opportunity to assist you in this project. Please call if you have any questions regarding this report.

Regards,

STANTEC CONSULTING LTD.

Jason Thompson, C.E.T.
Associate - Manager, Materials Testing Services
Phone: (204) 928-4004
Fax: (204) 488-6947
Jason.Thompson@stantec.com

Attachment: 1x – Moisture-density relationship (Proctor)
1x – Hydraulic Conductivity Test Report

PROCTOR TEST REPORT

TO J.R. Cousin Consultants Ltd.
91A Scurfield Blvd.
Winnipeg, MB
R3Y 1G4

CLIENT J.R. Cousin Consultants Ltd.
C.C.

ATTN: Oswald Wohlgenut

PROJECT Reston Lagoon Expansion

Reston

PROJECT NO. 123311472

PROCTOR NO. 1

DATE SAMPLED 2014.Sep.03

DATE RECEIVED 2014.Sep.04

DATE TESTED 2014.Sep.10

INSITU MOISTURE	18.3 %	COMPACTION STANDARD	Standard Proctor, ASTM D698
TESTED BY	Donald Eliazar	COMPACTION PROCEDURE	A: 101.6mm Mold, Passing 4.75mm
MATERIAL IDENTIFICATION		RAMMER TYPE	Manual
MATERIAL USE	Subgrade	PREPARATION	Moist
MAX. NOMINAL SIZE	Clay	OVERSIZE CORRECTION METHOD	None
MATERIAL TYPE	Clay	RETAINED 4.75mm SCREEN	
SUPPLIER	Not supplied		
SOURCE	Not supplied		

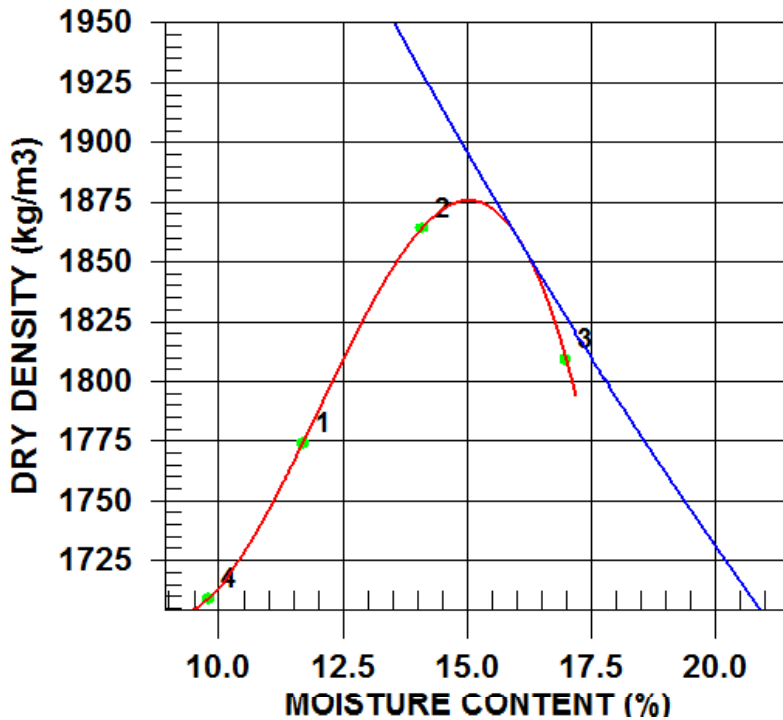

TRIAL NUMBER	WET DENSITY (kg/m ³)	DRY DENSITY (kg/m ³)	MOISTURE CONTENT (%)
1	1981	1774	11.7
2	2127	1864	14.1
3	2117	1809	17.0
4	1876	1709	9.8

	MAXIMUM DRY DENSITY (kg/m ³)	OPTIMUM MOISTURE CONTENT (%)
CALCULATED	1880	15.0
OVERSIZE CORRECTED		

COMMENTS

Sample obtained and submitted by client.



LABORATORY
 199 Henlow Bay
 Winnipeg MB R3Y 1G4
 Tel: (204) 488-6999

**HYDRAULIC CONDUCTIVITY
 ASTM D5084**

J.R. Cousin Consultants Ltd.
 91A Scurfield Blvd.
 Winnipeg, MB
 R3Y 1G4

PROJECT: Reston
 Lagoon Expansion

Attention: Oswald Wohlgemut

PROJECT NO.: 123311472

SAMPLE I.D.: TH10 at 0.2-4.5 m
SOIL DESCRIPTION: Brown, firm, moist, high plasticity clay trace silt and trace fine gravel
DATE TESTED: September 13 to September 24, 2014
CONFINING PRESSURE (kPa): 137.9
EFFECTIVE SATURATION STRESS (kPa): 34.5
ASSUMED SPECIFIC GRAVITY: 2.71
HYDRAULIC GRADIENT: 18.9
TYPE OF PERMEANT LIQUID: De-aired Water
HYDRAULIC CONDUCTIVITY, "k" (cm/s): 1.4E-08
HYDRAULIC CONDUCTIVITY, "k₂₀" (cm/s): 1.2E-08

	Height (mm)	Diameter (mm)	Wet Mass (g)	Dry Density (g/cm ³)	Water Content (%)	Saturation (%)
Initial Reading	78.5	71.5	669.8	1.844	15.2	87.7
Final Reading	78.5	71.5	669.8	1.844	15.2	87.7

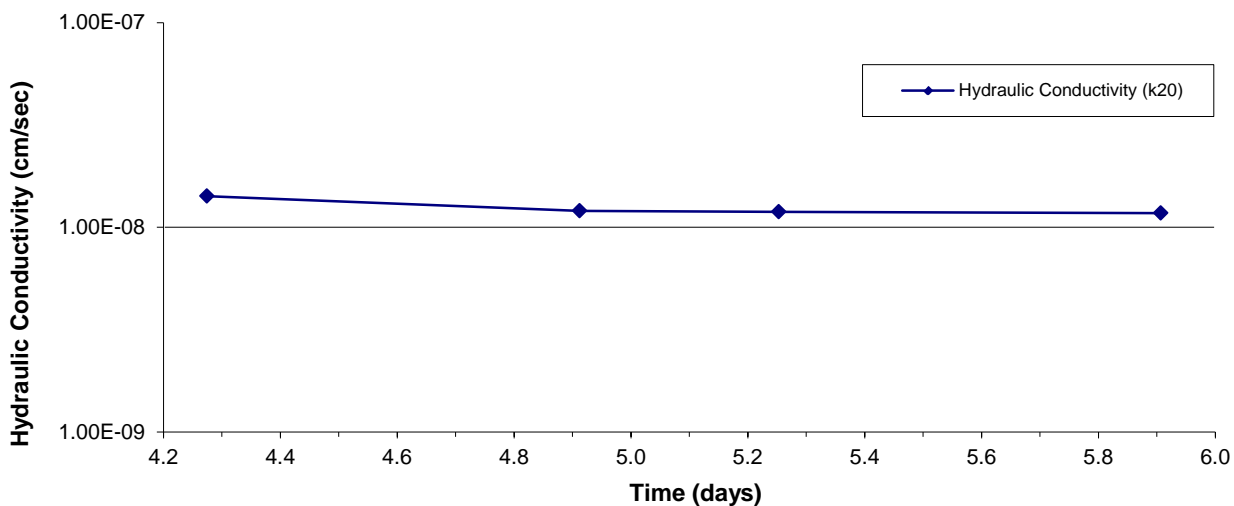

Note: Sample was compacted into 70 mm mold using the compactive effort outlined in standard test method ASTM D698, Method C prior to testing
 October 6, 2014
 REVIEWED BY: Jason Thompson, C.E.T.

Driller's Well Logs

LOCATION: NW6-7-27W

Well_PID: 62931
Owner: ELLIOT BROS
Driller: Paddock Drilling Ltd.
Well Name:
Well Use: PRODUCTION
Water Use: Livestock
UTMX: 345222.848
UTMY: 5490101.55
Accuracy XY: UNKNOWN
UTMZ:
Accuracy Z:
Date Completed: 1988 Jul 14

WELL LOG

From (ft.)	To (ft.)	Log
0	3.0	SILTY SAND
3.0	13.0	FINE TO MEDIUM FINE BROWN SAND
13.0	18.0	MEDIUM GREY SAND, CLEAN
18.0	38.0	GREY TILL

WELL CONSTRUCTION

From (ft.)	To (ft.)	Casing Type	Inside Dia.(in)	Outside Dia.(in)	Slot Size(in)	Type	Material
0	8.0	casing	30.00			CORRUGATED	
FIBERGLASS							
8.0	38.0	perforations	30.00		0.040	SAW CUT	
FIBERGLASS							
0	38.0	gravel pack					WASHED
S.							

Top of Casing: 1.5 ft. below ground

PUMPING TEST

Date: 1988 Jul 14
Pumping Rate: 11.0 Imp. gallons/minute
Water level before pumping: 21.0 ft. below ground
Pumping level at end of test: ?? ft. below ground
Test duration: 1 hours, 30 minutes
Water temperature: ?? degrees F

REMARKS

PUMP TEST IS RECOVERY

LOCATION: NW6-7-27W

Well_PID: 124118
Owner: RM OF PIPESTONE
Driller: Paddock Drilling Ltd.
Well Name: TH #1 - NORTH HOLE
Well Use: TEST WELL
Water Use:
UTMX: 345222.848
UTMY: 5490101.55
Accuracy XY:
UTMZ:
Accuracy Z:
Date Completed: 1993 Jun 21

WELL LOG

From (ft.)	To (ft.)	Log
0	0.2	TOPSOIL
0.2	4.0	BROWN SILT
4.0	17.0	FIRM BROWN TILL
17.0	21.0	FIRM GREY TILL

No construction data for this well.

Top of Casing: 0.0

No pump test data for this well.

REMARKS

BACKFILLED TO SURFACE USING CLAY DRILL CUTTINGS.

LOCATION: NW6-7-27W

Well_PID: 124119
Owner: RM OF PIPESTONE
Driller: Paddock Drilling Ltd.
Well Name: TH #2 - SOUTH HOLE
Well Use: TEST WELL
Water Use:
UTMX: 345222.848
UTMY: 5490101.55
Accuracy XY:
UTMZ:
Accuracy Z:
Date Completed: 1993 Jun 21

WELL LOG

From	To	Log
------	----	-----

(ft.)	(ft.)	
0	0.5	TOPSOIL
0.5	7.0	SANDY GRAVELLY TILL
7.0	16.0	FIRM BROWN TILL
16.0	21.0	FIRM GREY TILL

No construction data for this well.

Top of Casing: 0.0

No pump test data for this well.

REMARKS

BACKFILLED TO SURFACE USING CLAY DRILL CUTTINGS.

Appendix D

Title Page

Plan L1: Existing Lagoon and Test Hole Plan

Plan L2: Expanded Lagoon with Setbacks

Plan L3: Proposed Lagoon Layout Plan

Plan L4: Proposed Lagoon Drainage Route

Plan L5: Lagoon Dike Details

Plan L6: Lagoon Fence, Silt Fence, Valve and Rip Rap Details

RM OF PIPESTONE

RESTON LAGOON UPGRADE

ENVIRONMENT ACT PROPOSAL

PRELIMINARY
NOT FOR CONSTRUCTION

REDUCED DRAWING
DO NOT SCALE

PLAN INDEX

LAGOON

- PLAN L1.** EXISTING LAGOON AND TEST HOLE PLAN
- PLAN L2.** EXPANDED LAGOON WITH SETBACKS
- PLAN L3.** PROPOSED LAGOON LAYOUT PLAN
- PLAN L4.** PROPOSED LAGOON DRAINAGE ROUTE
- PLAN L5.** LAGOON DIKE DETAILS
- PLAN L6.** FENCE, SILT FENCE, VALVE AND RIP RAP DETAILS

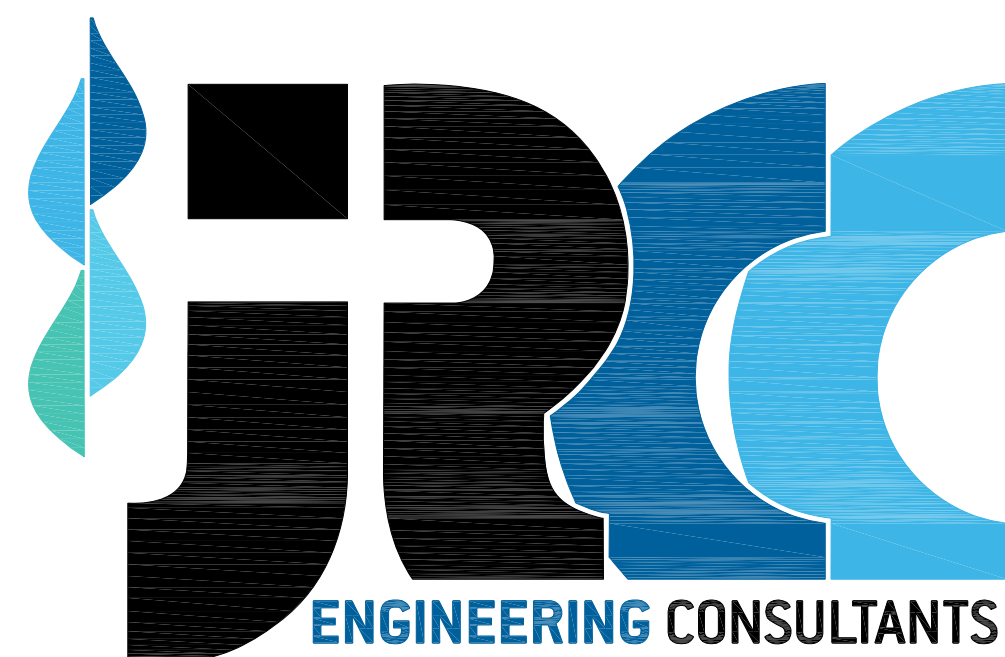

JR Cousin Consultants Ltd.

91A Scurfield Blvd. Winnipeg MB R3Y 1G4

p. (204) 489-0474

f. (204) 489-0487

www.jrcc.ca

ENGINEERING EXCELLENCE SINCE 1981



PRELIMINARY
NOT FOR CONSTRUCTION

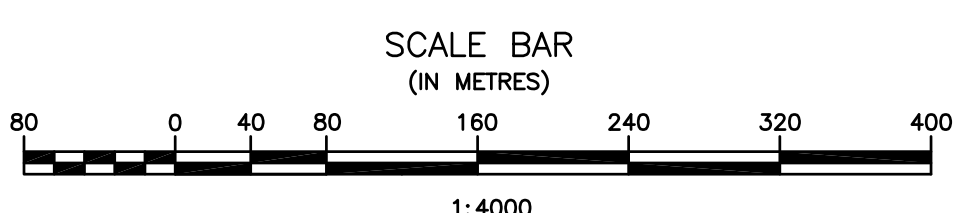

No.	REVISIONS	DATE	INITIALS

B.M. EL.

LOCATIONS OF UNDERGROUND STRUCTURES/UTILITIES AS SHOWN ARE BASED ON AVAILABLE INFORMATION BUT NO GUARANTEE IS GIVEN OR IMPLIED THAT ALL EXISTING UNDERGROUND STRUCTURES/UTILITIES ARE SHOWN OR THAT THE GIVEN LOCATIONS ARE EXACT. CONFIRMATION OF EXISTENCE AND EXACT LOCATION OF ALL UNDERGROUND STRUCTURES/UTILITIES MUST BE OBTAINED FROM THE APPROPRIATE AUTHORITY/OWNER, BY THE CONTRACTOR, BEFORE PROCEEDING WITH CONSTRUCTION.

APEGM
Certificate of Authorization
J.R. Cousin Consultants Ltd.
No. 234 Date: 15/03/23

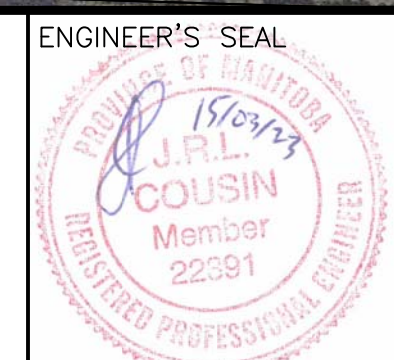

JR Cousin Consultants Ltd.
91A Scurfield Blvd. Winnipeg MB R3Y 1G4
p. (204) 489-0474
f. (204) 489-0487
www.jrcc.ca

ENGINEERING CONSULTANTS
ENGINEERING EXCELLENCE SINCE 1981

CODE: P-118.07	PROJECT: RM OF PIPESTONE RESTON LAGOON STUDY
DESIGNED BY: JRC	TITLE: EXISTING LAGOON AND TEST HOLE PLAN
DRAWN BY: RH	SCALE: 1:4000
REVIEWED BY: JRC	DATE: 14/03/13
	PLAN: L1
	SHEET: 1 of 6

Mar 23, 2013 - 2:58pm P:\103118_Pipestone\11807_Pipestone and Reston W Lagoon Studies\Reston\04_Drawing\Map\Aerial_L1.dwg



PRELIMINARY
NOT FOR CONSTRUCTION

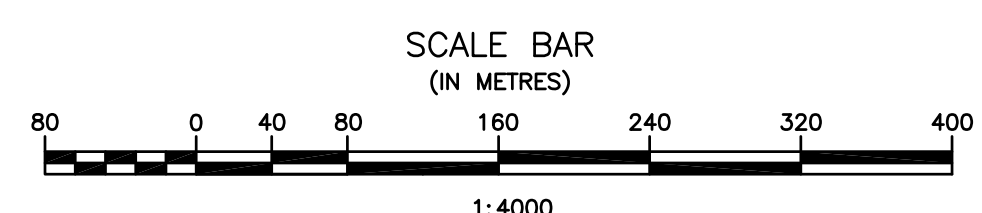

No.	REVISIONS	DATE	INITIALS

B.M. EL.

LOCATIONS OF UNDERGROUND STRUCTURES/UTILITIES AS SHOWN ARE BASED ON AVAILABLE INFORMATION BUT NO GUARANTEE IS GIVEN OR IMPLIED THAT ALL EXISTING UNDERGROUND STRUCTURES/UTILITIES ARE SHOWN OR THAT THE GIVEN LOCATIONS ARE EXACT. CONFIRMATION OF EXISTENCE AND EXACT LOCATION OF ALL UNDERGROUND STRUCTURES/UTILITIES MUST BE OBTAINED FROM THE APPROPRIATE AUTHORITY/OWNER, BY THE CONTRACTOR, BEFORE PROCEEDING WITH CONSTRUCTION.

APEGM
Certificate of Authorization
J.R. Cousin Consultants Ltd.
No. 234 Date: 15/03/23

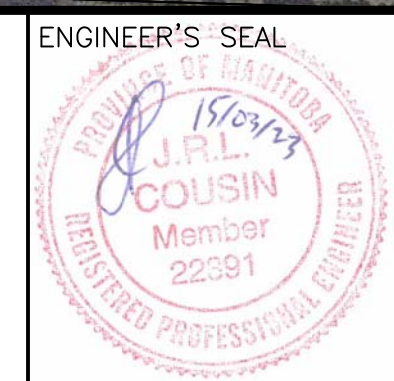

JR Cousin Consultants Ltd.
91A Scurfield Blvd. Winnipeg MB R3Y 1G4
p. (204) 489-0474
f. (204) 489-0487
www.jrcc.ca

ENGINEERING CONSULTANTS
ENGINEERING EXCELLENCE SINCE 1981

CODE: P-118.07	PROJECT: RM OF PIPESTONE RESTON LAGOON STUDY
DESIGNED BY: JRC	TITLE: EXPANDED LAGOON WITH SETBACKS
DRAWN BY: RH	SCALE: 1:4000
REVIEWED BY: JRC	DATE: 14/03/13
	PLAN: L2
	SHEET: 2 of 6

Mar 23, 2013 - 2:05pm P:\100\118 Pipestone\118.07 Pipestone and Reston W. Lagoon Studies\Reston\04 Drawings\DWG\DL1.L2.rvt

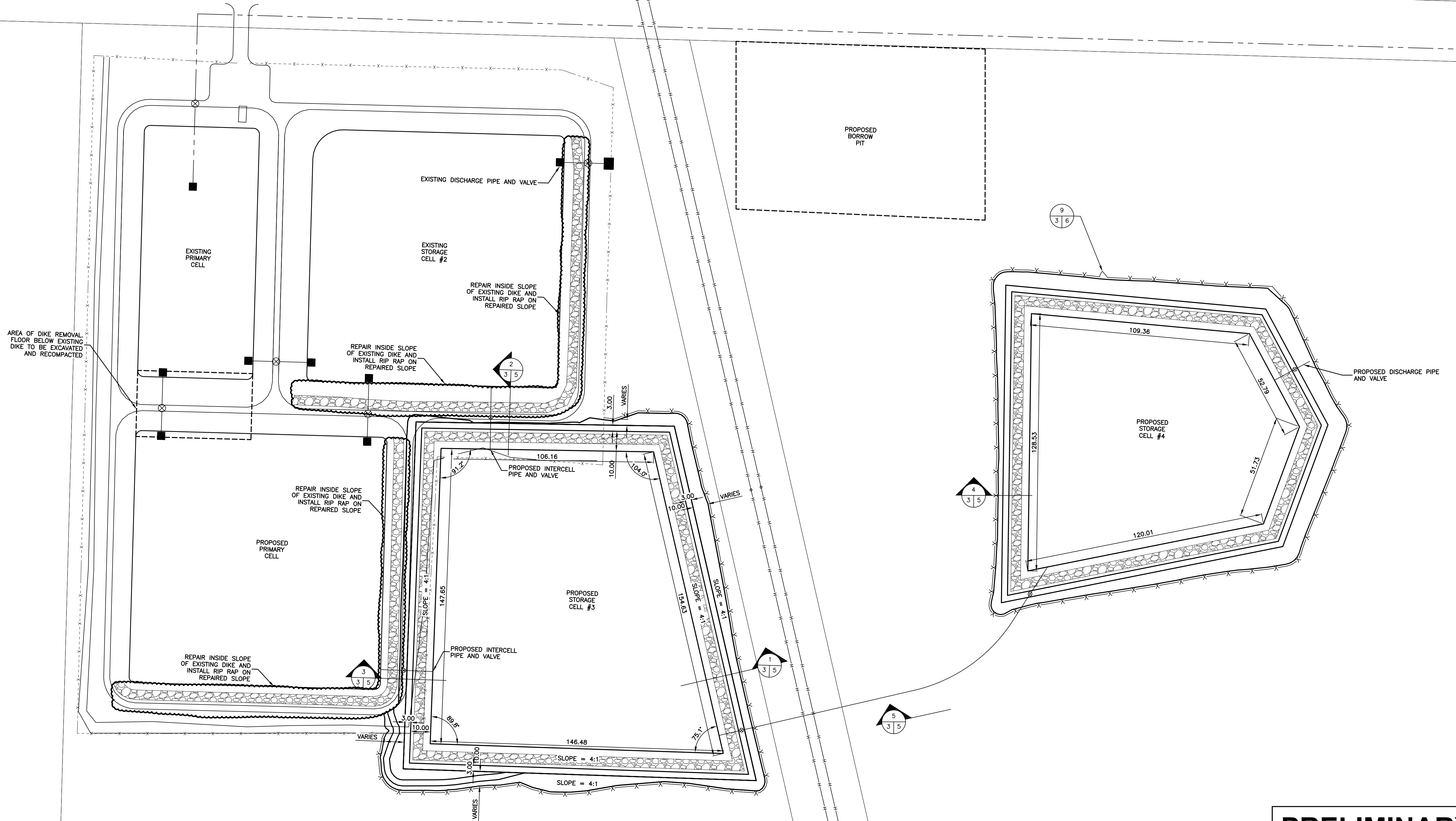
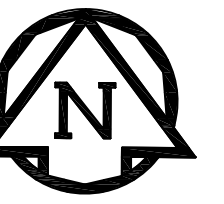

PRELIMINARY
NOT FOR CONSTRUCTION

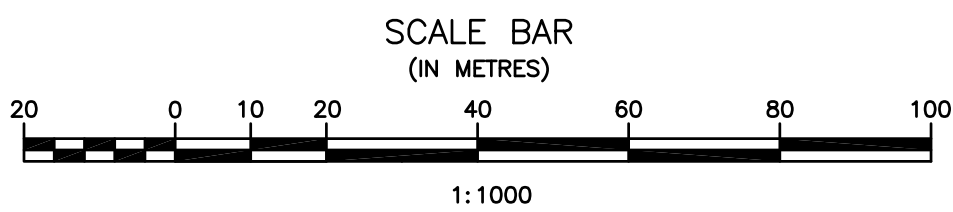

No.	REVISIONS	DATE	INITIALS	B.M. EL.

LOCATIONS OF UNDERGROUND STRUCTURES/UTILITIES AS SHOWN ARE BASED ON AVAILABLE INFORMATION BUT NO GUARANTEE IS GIVEN OR IMPLIED THAT ALL EXISTING UNDERGROUND STRUCTURES/UTILITIES ARE SHOWN OR THAT THE GIVEN LOCATIONS ARE EXACT. CONFIRMATION OF EXISTENCE AND EXACT LOCATION OF ALL UNDERGROUND STRUCTURES/UTILITIES MUST BE OBTAINED FROM THE APPROPRIATE AUTHORITY/OWNER, BY THE CONTRACTOR, BEFORE PROCEEDING WITH CONSTRUCTION.

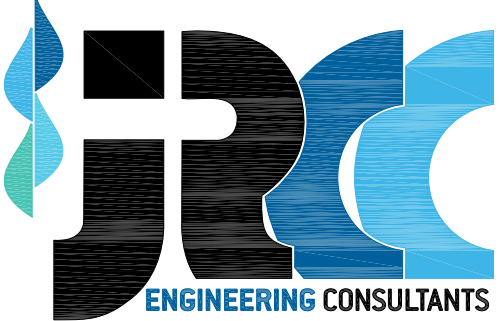

JR Cousin Consultants Ltd.
91A Scurfield Blvd. Winnipeg MB R3Y 1G4
p. (204) 489-0474
f. (204) 489-0487
www.jrcc.ca

CODE: P-118.07	PROJECT: RM OF PIPESTONE RESTON LAGOON STUDY
DESIGNED BY: JRC	TITLE: PROPOSED LAGOON LAYOUT PLAN
DRAWN BY: RH	SCALE: 1:1000
REVIEWED BY: JRC	DATE: 13/11/28
	PLAN: L3
	SHEET: 3 of 6

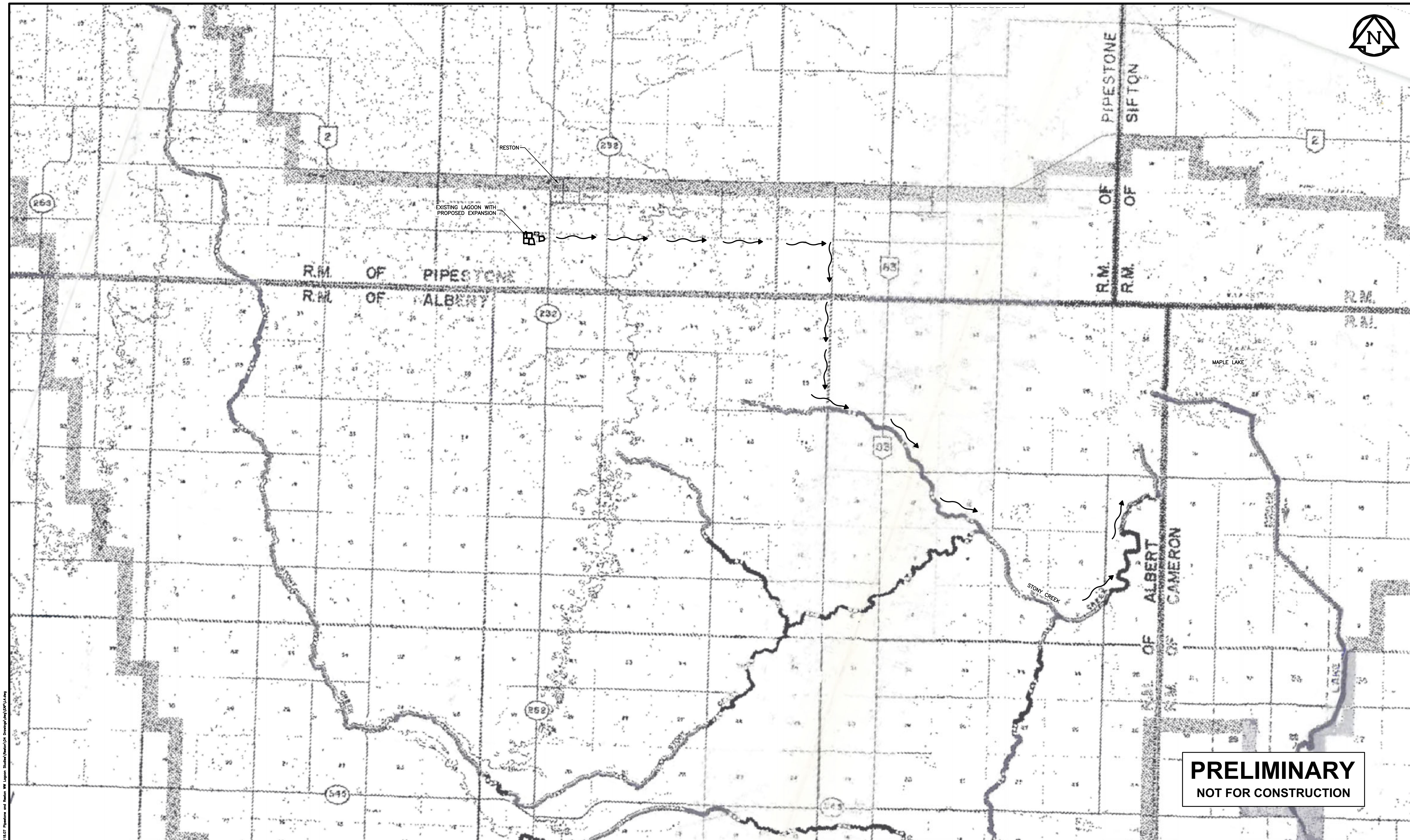

PRELIMINARY
NOT FOR CONSTRUCTION

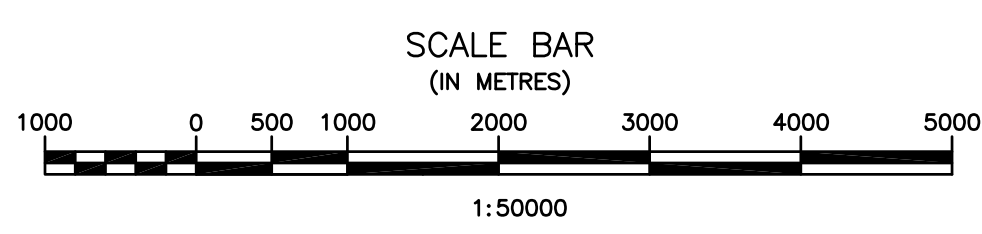

No.	REVISIONS	DATE	INITIALS

B.M. EL.

LOCATIONS OF UNDERGROUND STRUCTURES/UTILITIES AS SHOWN ARE BASED ON AVAILABLE INFORMATION BUT NO GUARANTEE IS GIVEN OR IMPLIED THAT ALL EXISTING UNDERGROUND STRUCTURES/UTILITIES ARE SHOWN OR THAT THE GIVEN LOCATIONS ARE EXACT. CONFIRMATION OF EXISTENCE AND EXACT LOCATION OF ALL UNDERGROUND STRUCTURES/UTILITIES MUST BE OBTAINED FROM THE APPROPRIATE AUTHORITY/OWNER, BY THE CONTRACTOR, BEFORE PROCEEDING WITH CONSTRUCTION.

APEGM
Certificate of Authorization
J.R. Cousin Consultants Ltd.
No. 234 Date: 15/03/23

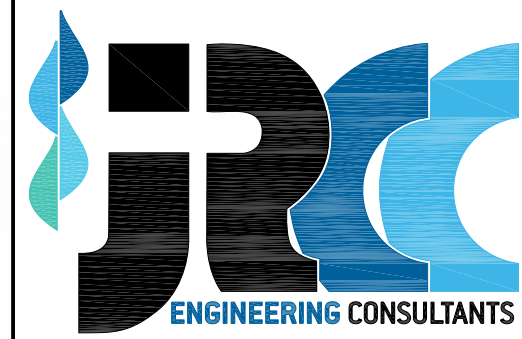
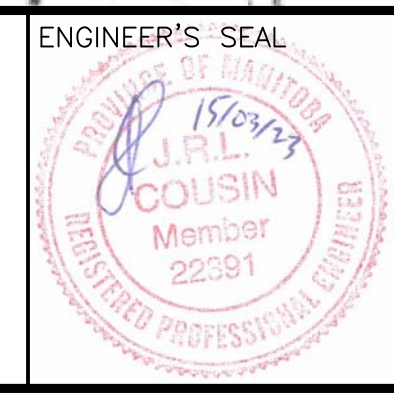

JR Cousin Consultants Ltd.
91A Scurfield Blvd. Winnipeg MB R3Y 1G4
p. (204) 489-0474
f. (204) 489-0487
www.jrcc.ca

CODE:	P-118.07
DESIGNED BY:	JRC
DRAWN BY:	DK
REVIEWED BY:	JRC

PROJECT:	RM OF PIPESTONE RESTON LAGOON STUDY
TITLE:	PROPOSED LAGOON DRAINAGE ROUTE
SCALE:	1:50000
DATE:	13/11/28
PLAN:	L4
SHEET:	4 of 6

Mar 23, 2015 - 2:58pm P:\100\118 Pipestone\11807 Pipestone and Reston W Lagoon Studies\Reston\04 Drainage\Map\11807.dwg

LEGEND:

- EXCAVATED AND COMPACTED MEDIUM PLASTIC CLAY TYPE SOIL
- EXCAVATED AND COMPACTED MIXTURE OF SOILS
- INSITU MEDIUM PLASTIC CLAY TYPE SOIL
- EXISTING TOPSOIL
- EXISTING DIKE
- RIP RAP
- TOPSOIL
- EXCAVATED AND COMPACTED MEDIUM PLASTIC CLAY TYPE SOIL
- EXISTING LINER
- SAND BEDDING

LEVEL 1 - PRE-CONSTRUCTION EXISTING GROUND ELEVATION
 LEVEL 2 - ELEVATION FOLLOWING TOPSOIL REMOVAL
 LEVEL 3 - FINISHED CELL BOTTOM ELEVATION
 LEVEL 4 - BOTTOM OF HORIZONTAL LINER AND CUTOFF WALL

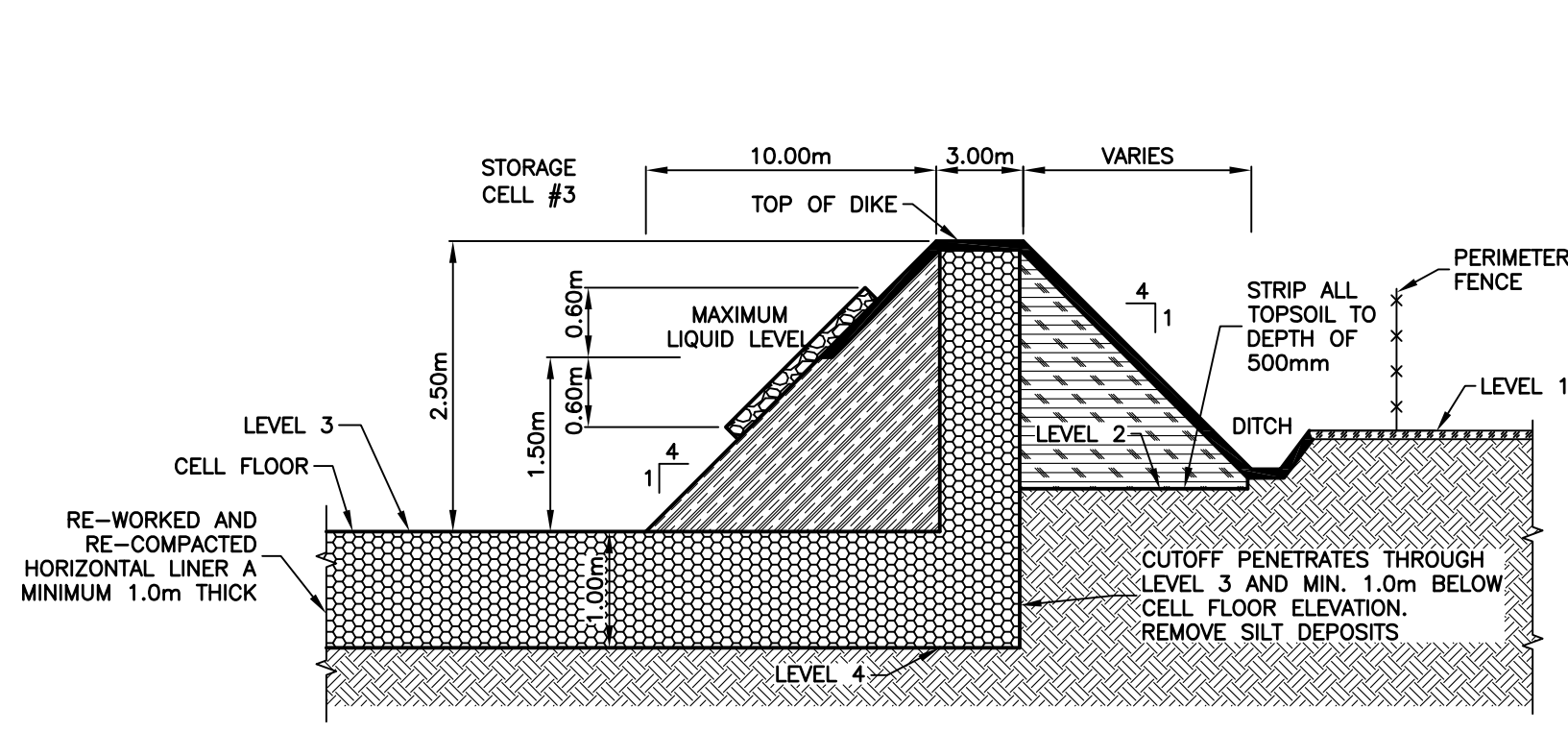

1 PERIMETER DIKE IN STORAGE CELL #3
 HOR = 1:250
 VER = 1:62.5

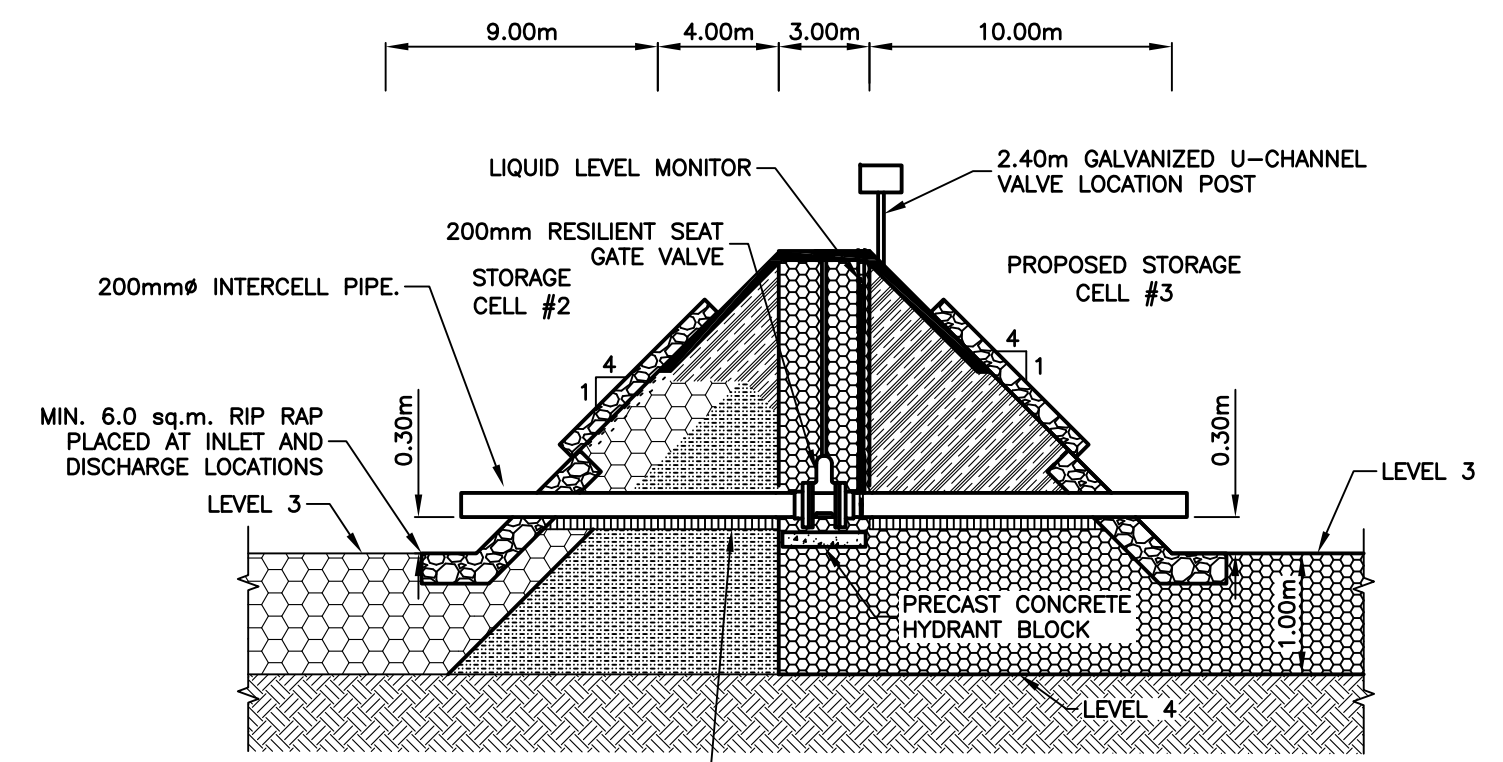

2 INTERCELL DIKE AT INTERCELL PIPE
 HOR = 1:250
 VER = 1:62.5

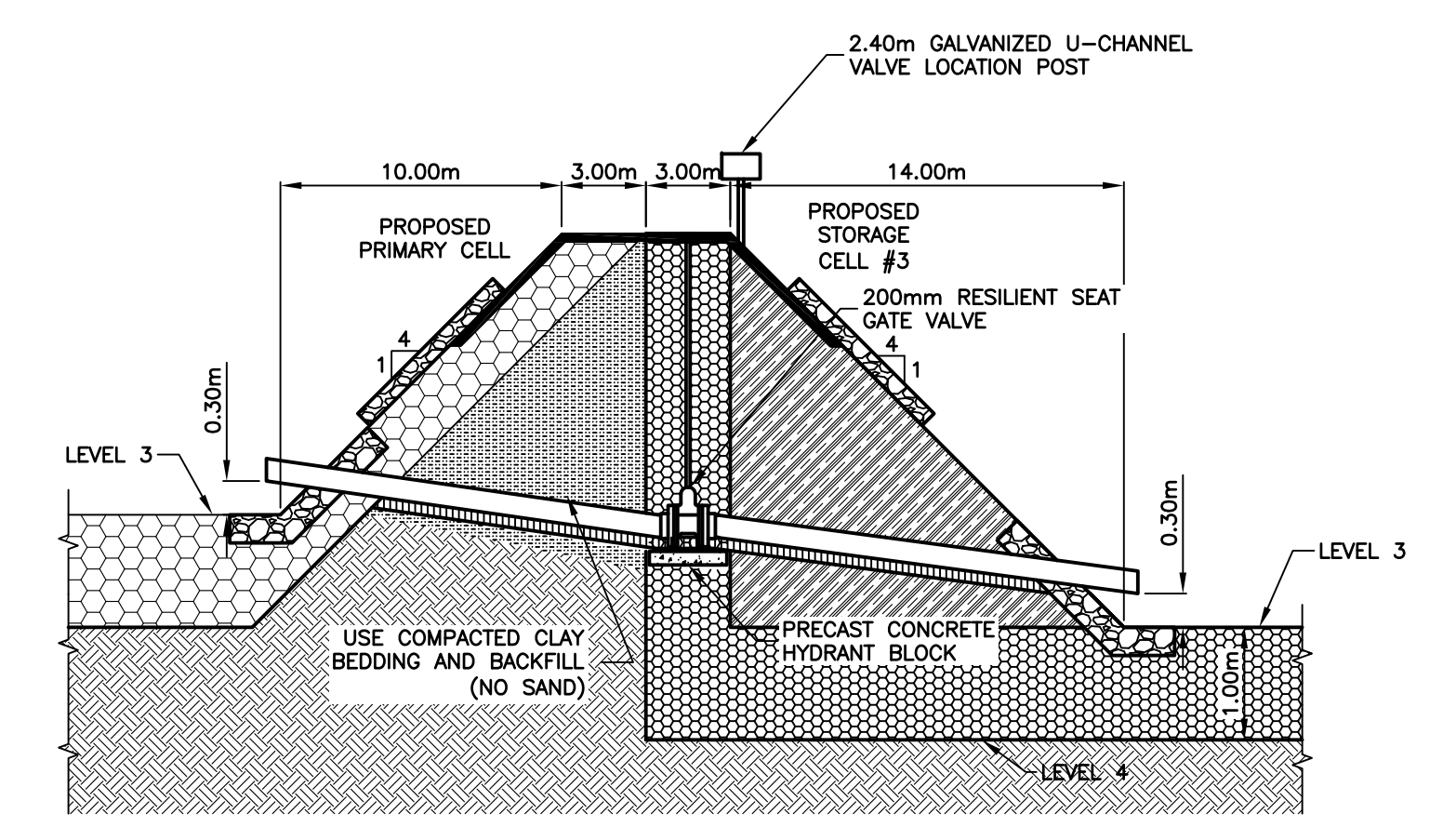

3 INTERCELL DIKE AT INTERCELL PIPE
 HOR = 1:250
 VER = 1:62.5

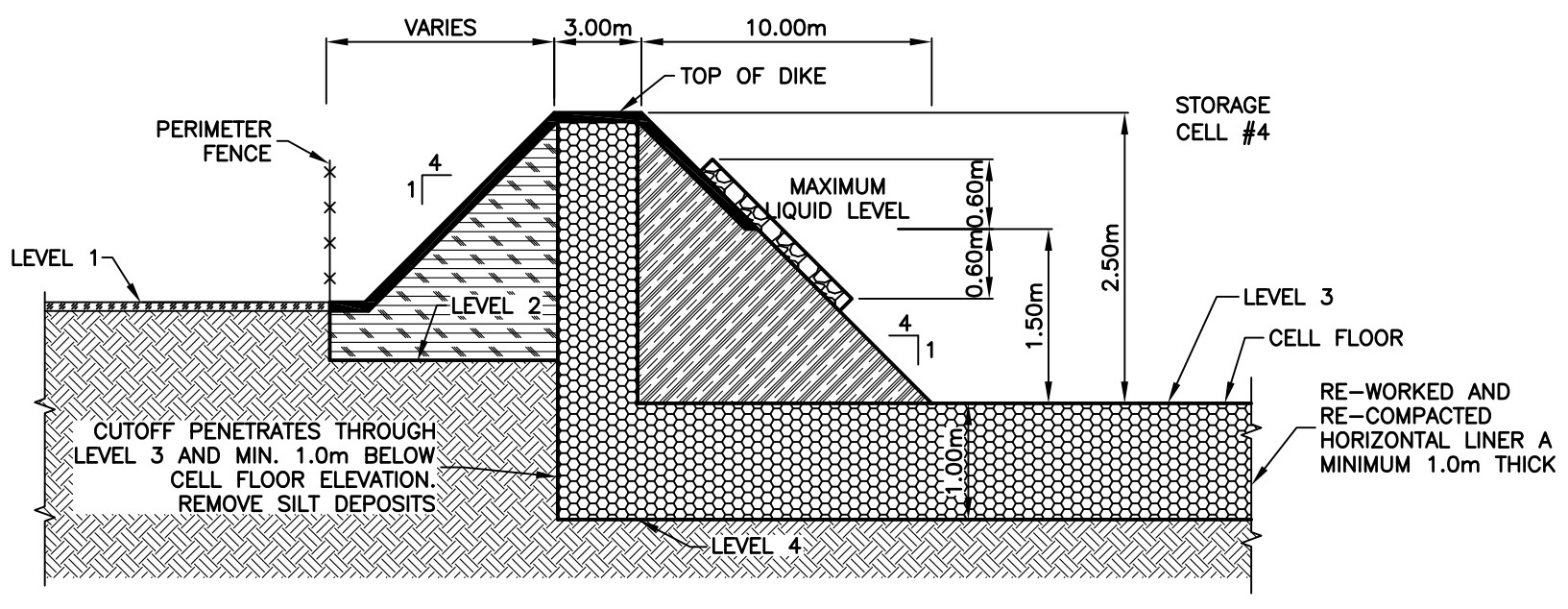

4 PERIMETER DIKE IN STORAGE CELL #4
 HOR = 1:250
 VER = 1:62.5

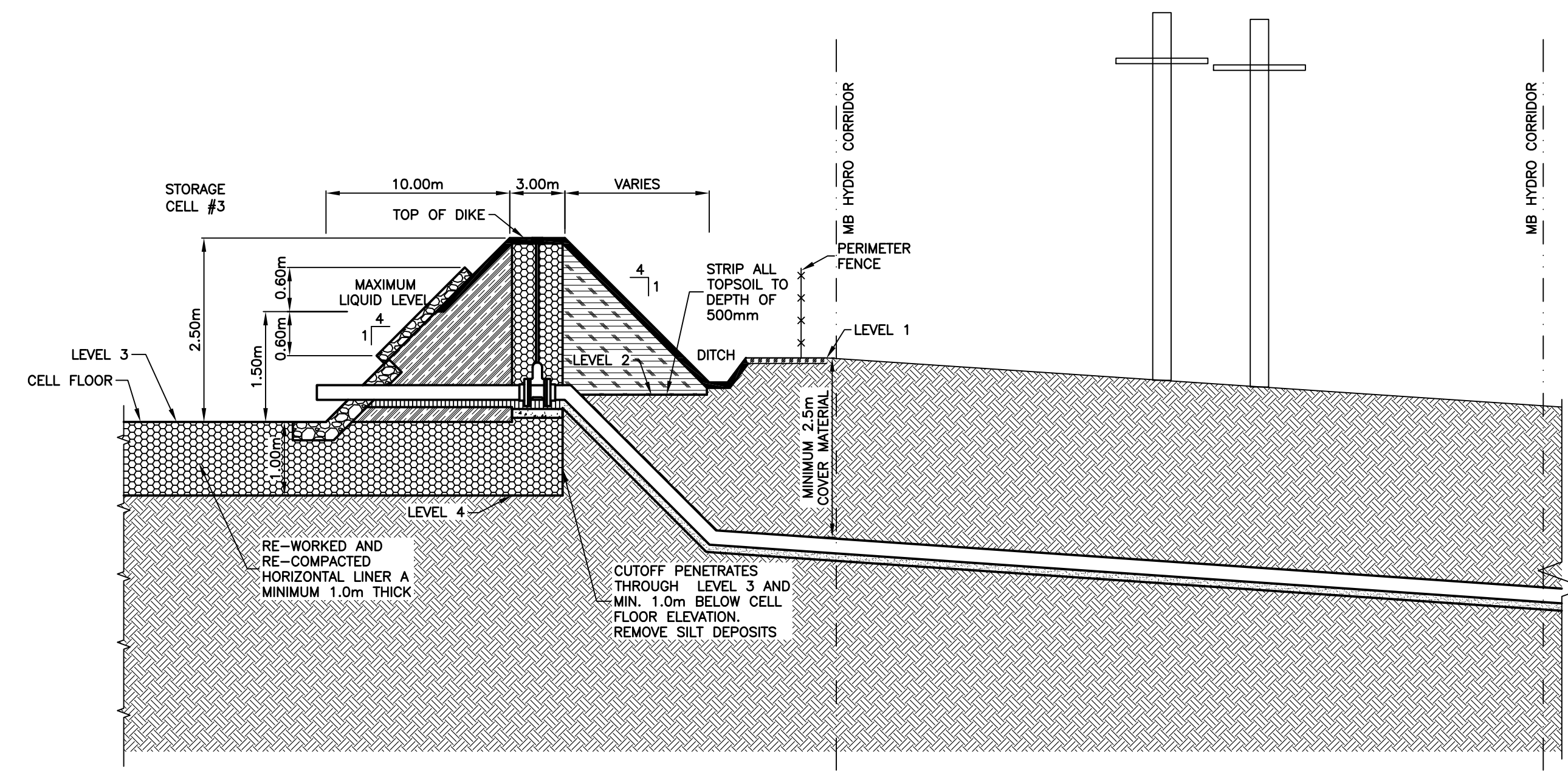

1 INTERCELL PIPE FOR STORAGE CELL #3 TO STORAGE CELL #4
 HOR = 1:250
 VER = 1:62.5

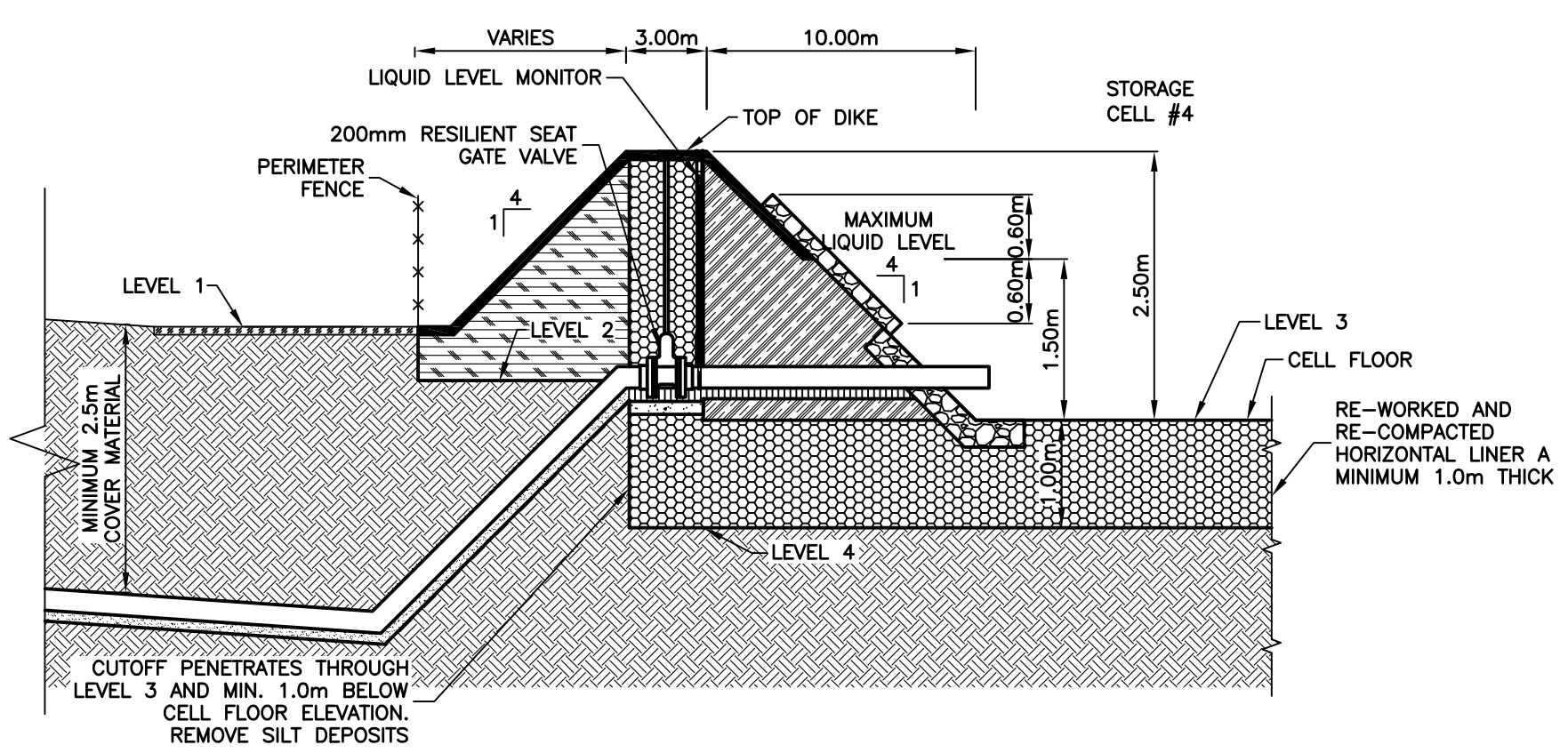

PRELIMINARY
 NOT FOR CONSTRUCTION

No.	REVISIONS	DATE	INITIALS

B.M. EL.
 LOCATIONS OF UNDERGROUND STRUCTURES/UTILITIES AS SHOWN ARE BASED ON AVAILABLE INFORMATION BUT NO GUARANTEE IS GIVEN OR IMPLIED THAT ALL EXISTING UNDERGROUND STRUCTURES/UTILITIES ARE SHOWN OR THAT THE GIVEN LOCATIONS ARE EXACT. CONFIRMATION OF EXISTENCE AND EXACT LOCATION OF ALL UNDERGROUND STRUCTURES/UTILITIES MUST BE OBTAINED FROM THE APPROPRIATE AUTHORITY/OWNER, BY THE CONTRACTOR, BEFORE PROCEEDING WITH CONSTRUCTION.

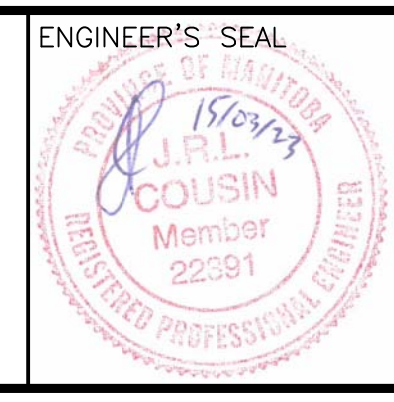
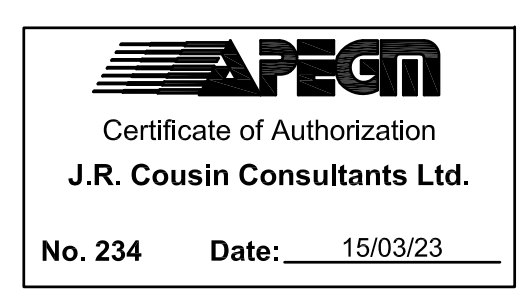

JR Cousin Consultants Ltd.
 91A Scurfield Blvd. Winnipeg MB R3Y 1G4
 p. (204) 489-0474
 f. (204) 489-0487
 www.jrcc.ca
 ENGINEERING EXCELLENCE SINCE 1981

CODE: P-118.07	PROJECT: RM OF PIPESTONE RESTON LAGOON STUDY
DESIGNED BY: JRC	TITLE: LAGOON DIKE, FENCE, SILT FENCE, VALVE AND RIP RAP DETAILS
DRAWN BY: RH	SCALE: AS NOTED
REVIEWED BY: JRC	DATE: 14/03/13
	PLAN: L5
	SHEET: 5 of 6

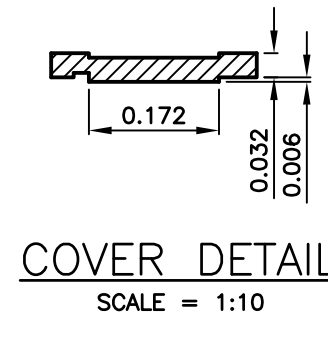

COVER DETAIL
SCALE = 1:10

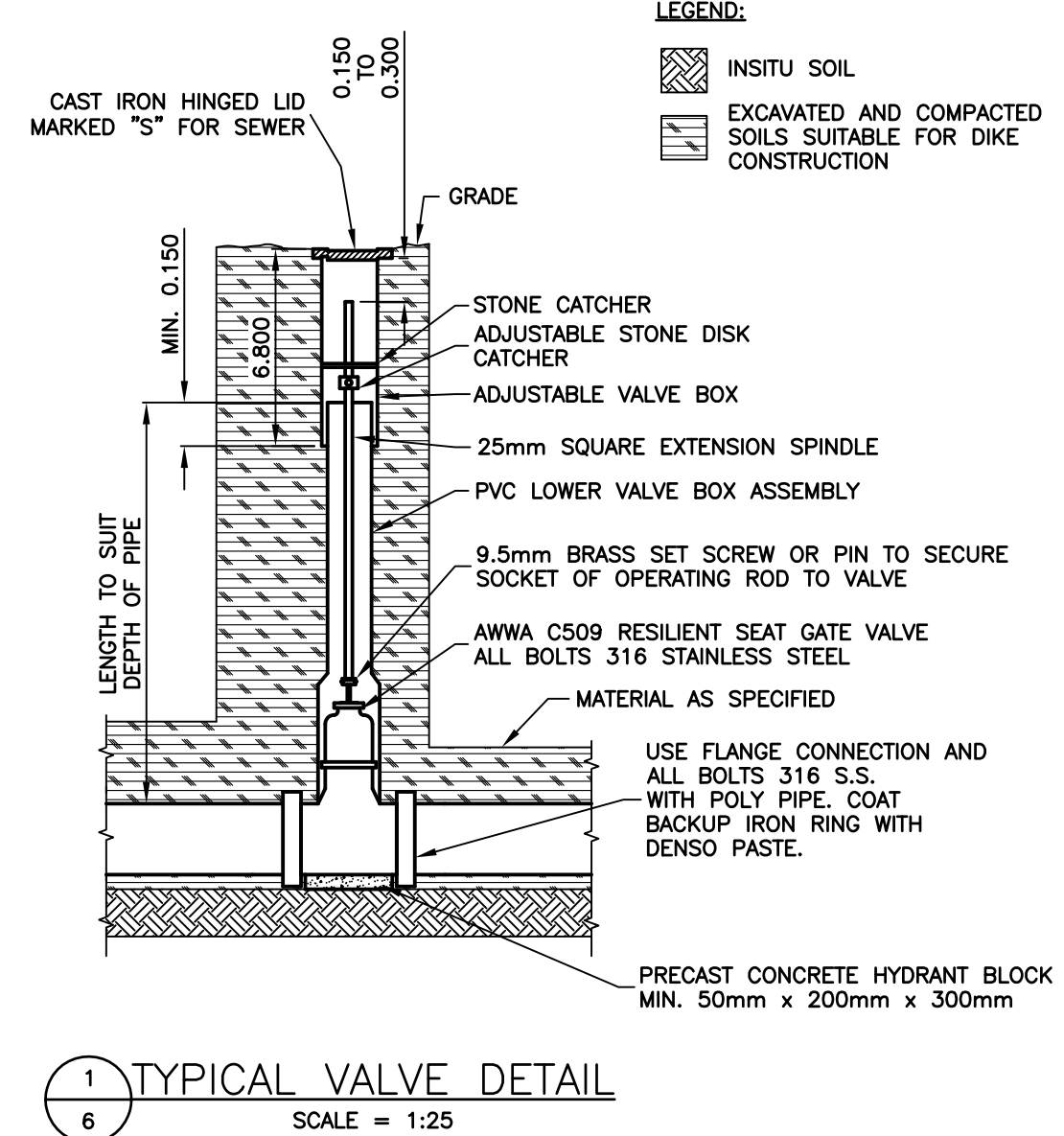

1 TYPICAL VALVE DETAIL
SCALE = 1:25

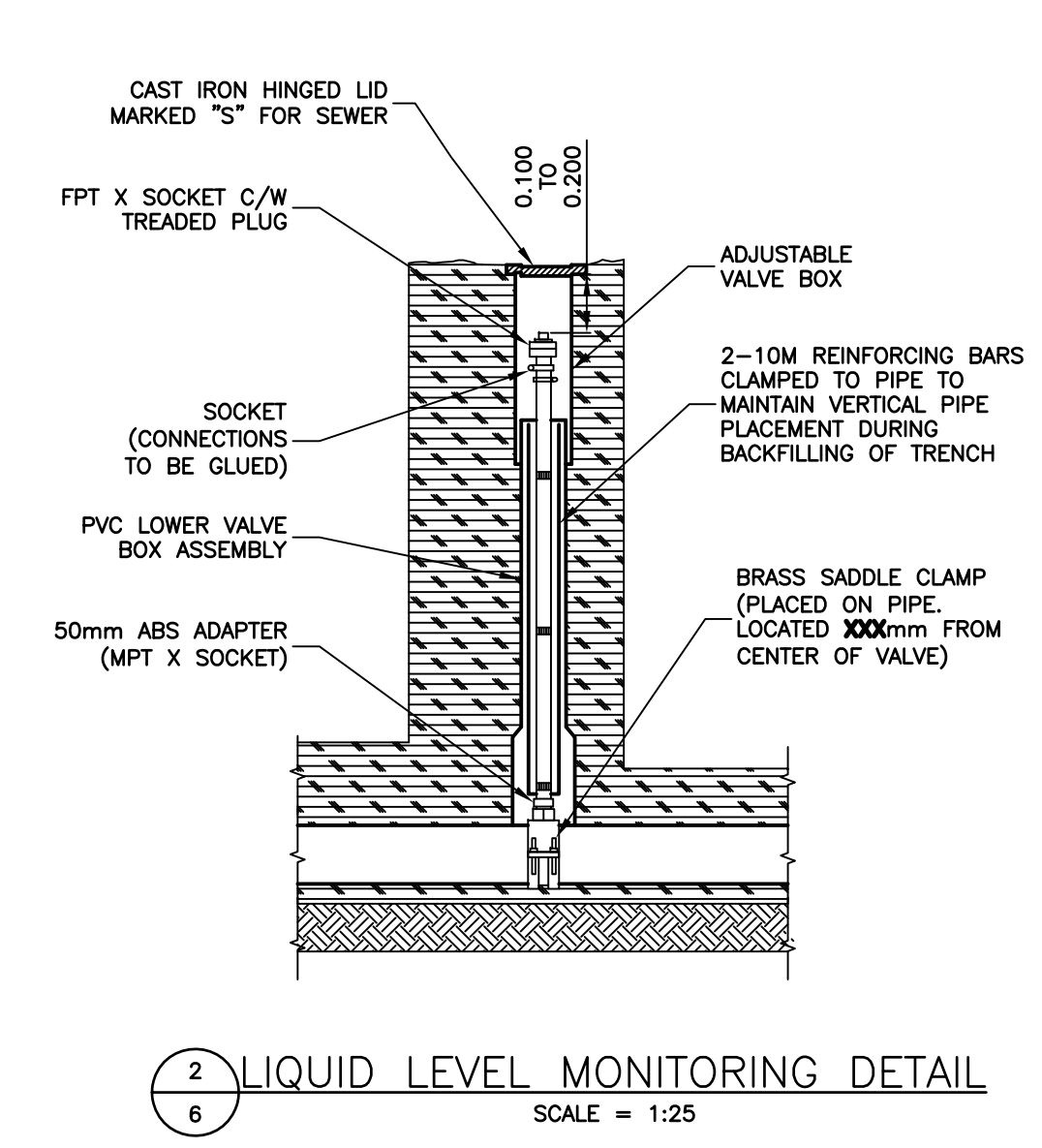

2 LIQUID LEVEL MONITORING DETAIL
SCALE = 1:25

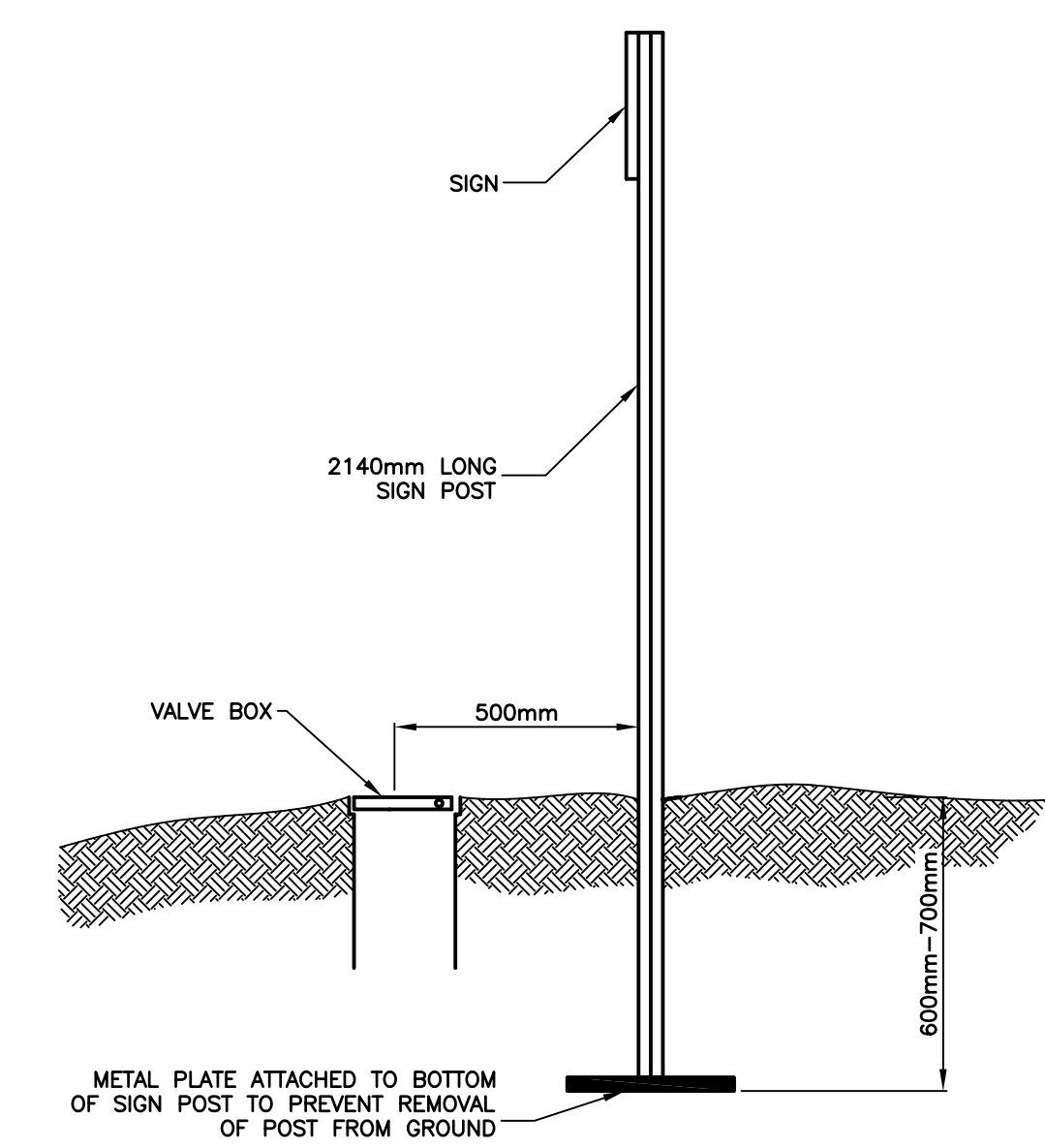

3 VALVE MARKER DETAIL
SCALE = 1:15

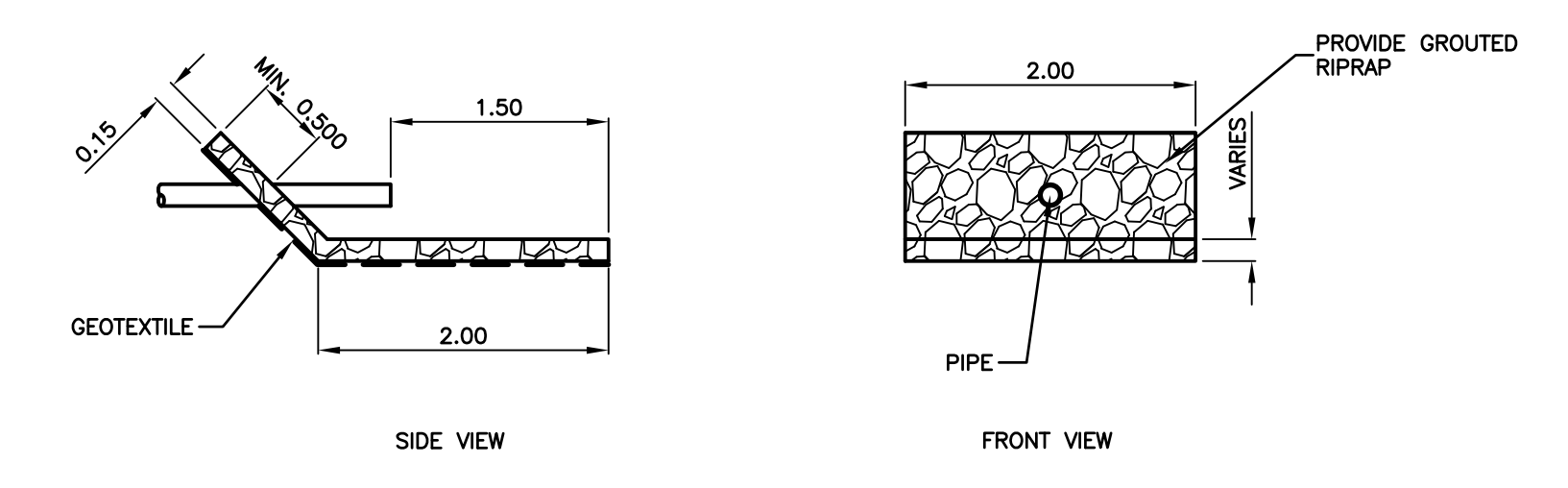

4 RIPRAP DETAIL
SCALE = 1:50

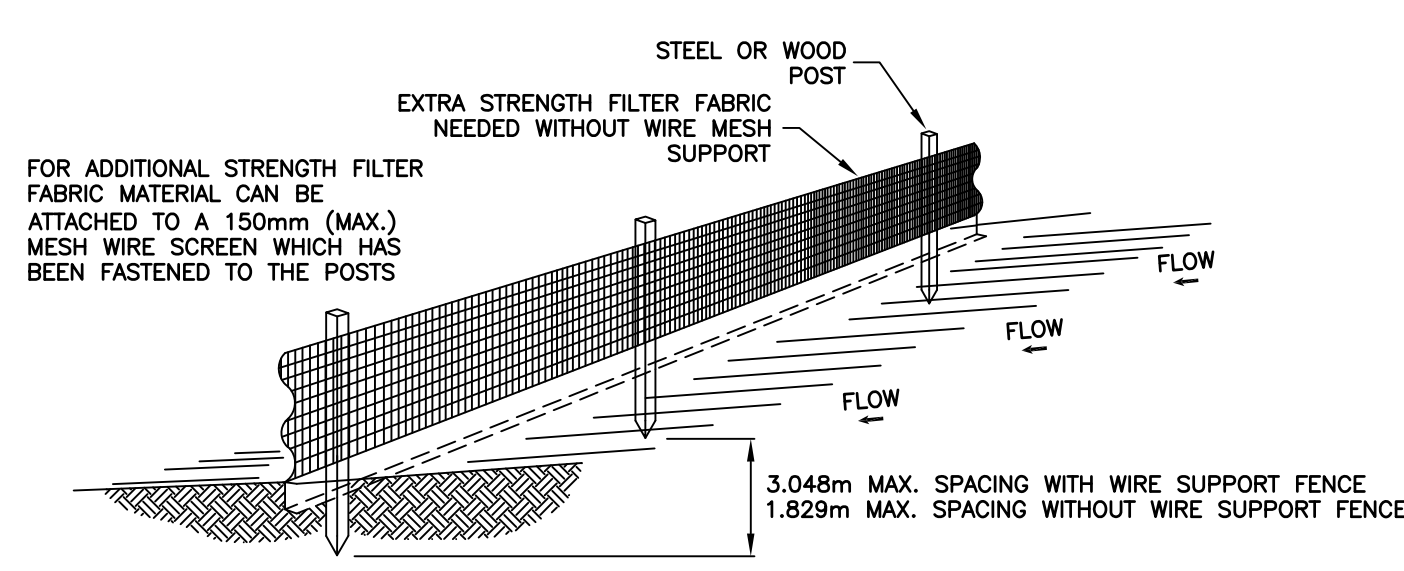

- NOTES:**
- THE HEIGHT OF A SILT FENCE SHALL NOT EXCEED 914mm.
 - THE FILTER FABRIC SHALL BE PURCHASED IN A CONTINUOUS ROLL CUT TO THE LENGTH OF THE BARRIER TO AVOID THE USE OF JOINTS.
 - POSTS SHALL BE SPACED A MAXIMUM OF 3.048m APART AT THE BARRIER LOCATION AND DRIVEN SECURELY INTO THE GROUND A MINIMUM OF 300mm. WHEN EXTRA STRENGTH FABRIC IS USED WITHOUT THE WIRE SUPPORT FENCE, POST SPACING SHALL NOT EXCEED 1.829m.
 - A TRENCH SHALL BE EXCAVATED APPROXIMATELY 100mm WIDE AND 100mm DEEP ALONG THE LINE OF POSTS AND UPSLOPE FROM THE BARRIER.
 - WHEN STANDARD STRENGTH FILTER FABRIC IS USED, A WIRE MESH SUPPORT FENCE SHALL BE FASTENED SECURELY TO THE UPSLOPE SIDE OF THE POSTS USING HEAVY DUTY WIRE STAPLES AT LEAST 25mm LONG, THE WIRES, OR HOG RINGS. THE WIRE SHALL EXTEND INTO THE TRENCH A MINIMUM OF 50mm AND SHALL NOT EXTEND MORE THAN 914mm ABOVE THE ORIGINAL GROUND SURFACE.
 - THE STANDARD STRENGTH FILTER FABRIC SHALL BE STAPLED OR WIRED TO THE FENCE, AND 200mm OF THE FABRIC SHALL BE EXTENDED INTO THE TRENCH. THE FABRIC SHALL NOT EXTEND MORE THAN 914mm ABOVE THE ORIGINAL GROUND SURFACE.
 - THE TRENCH SHALL BE BACKFILLED AND THE SOIL COMPACTED OVER THE FILTER FABRIC.
 - SILT FENCING TO BE POLYPROPYLENE SYNTHETIC FIBRE WITH ULTRAVIOLET STABILIZERS. AMOCO 1198 OR APPROVED EQUAL.
 - WOOD POSTS TO BE 38mm X 89mm (2" X 4"), POINTED AT ONE END AND FABRICATED.
 - INSTALL ALL SUPPORTING POSTS ON THE DOWN SLOPE SIDE OF THE FENCING.
 - MAINTAIN SILT FENCE THROUGHOUT CONSTRUCTION AND UNTIL REVEGETATION OCCURS.

5 SILT FENCE DETAIL
SCALE = NTS

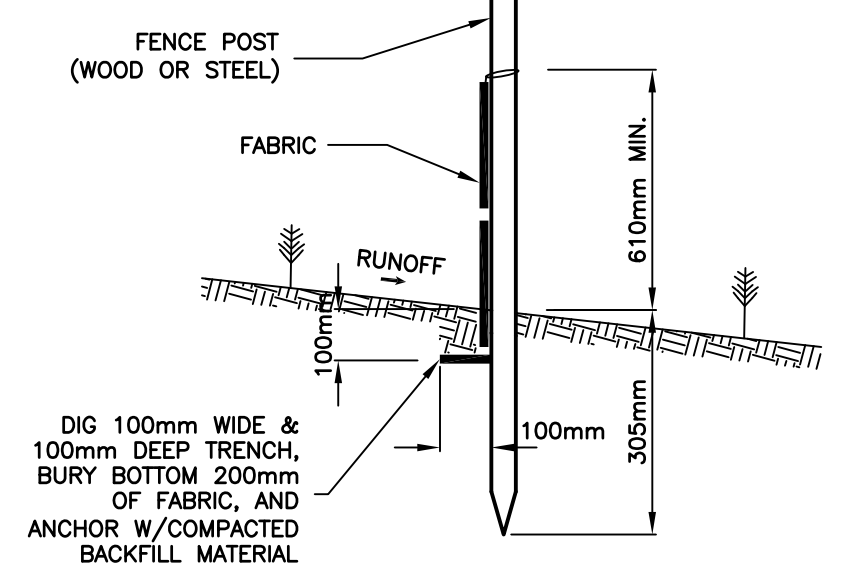

6 SILT FENCE SECTION
SCALE = NTS

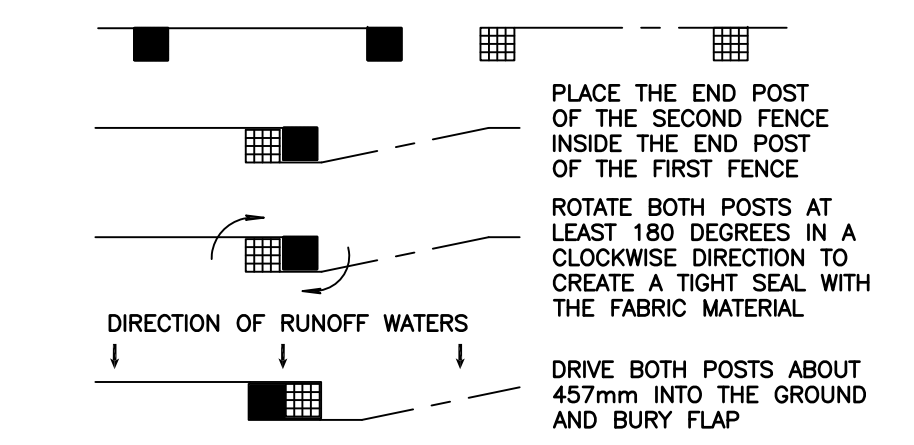

7 ATTACHING TWO SILT FENCES
SCALE = NTS

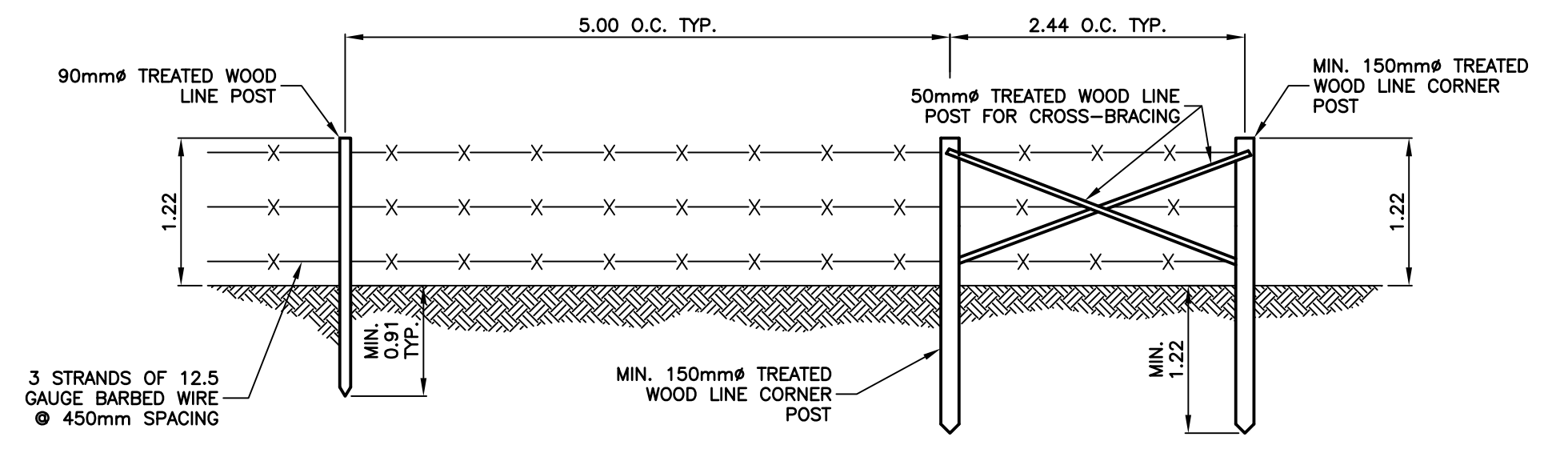

- NOTE:**
- PROVIDE CROSS BRACING AT CORNERS POSTS IN BOTH DIRECTIONS.
 - SHOWN DIAMETER REFERS TO SMALLEST END OF POST.

8 FENCE DETAIL
SCALE = 1:50

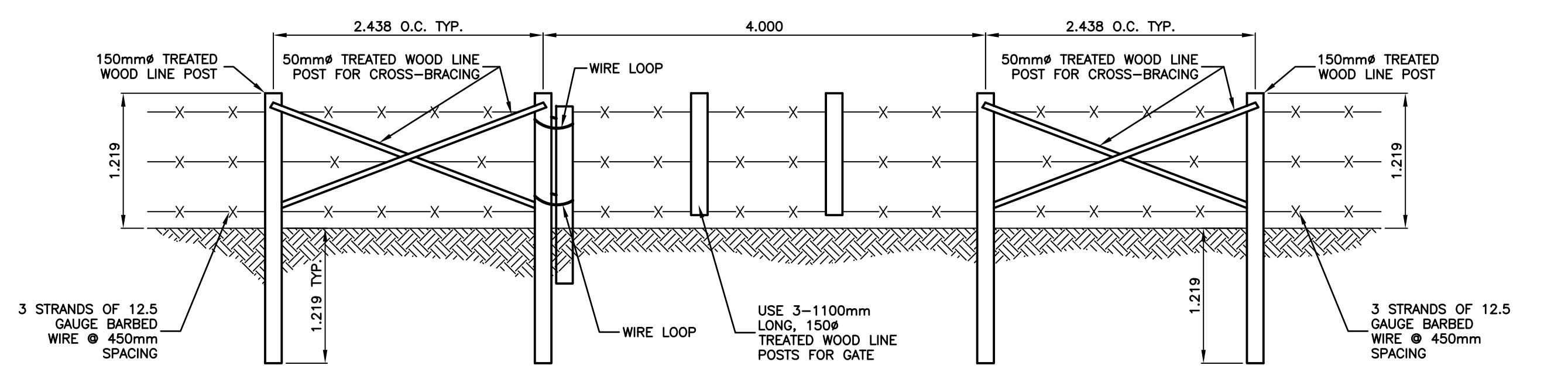

- NOTE:**
- PROVIDE CROSS BRACING AT CORNERS POSTS IN BOTH DIRECTIONS

9 BARBWIRE FENCE AND GATE
SCALE = 1:40

PRELIMINARY
NOT FOR CONSTRUCTION

No.	REVISIONS	DATE	INITIALS	B.M. EL.

 Certificate of Authorization J.R. Cousin Consultants Ltd. No. 234 Date: 15/03/23	 ENGINEER'S SEAL J.R. COUSIN Member 22381	 JR Cousin Consultants Ltd. 91A Scurfield Blvd. Winnipeg MB R3Y 1G4 p. (204) 489-0474 f. (204) 489-0487 www.jrcc.ca	CODE: P-118.07	PROJECT: RM OF PIPESTONE RESTON LAGOON STUDY
			DESIGNED BY: JRC	TITLE: LAGOON DIKE, FENCE, SILT FENCE, AND RIP RAP DETAILS
DRAWN BY: RH	REVIEWED BY: JRC	SCALE: AS NOTED	DATE: 14/03/13	PLAN: L6
		ENGINEERING EXCELLENCE SINCE 1981	SHEET: 6 of 6	

Mar 23, 2015 - 2:27pm P:\100\1118 Prelim\1118 Prelim\1118.07 Prelim.dwg and Hason W. Lagon Student\Hason\1118 Prelim\1118.07 Prelim.dwg